



日煬科技有限公司
JD Auspice Co., Ltd.

pvBos®

直流匯流箱

PC箱體材質保固20年
(限非外力損壞)

環境監測箱 高低壓盤



CNS 15426-1
CNS 15426-1:2011
UL 1741:2010
C22.2 NO.107.1-01(R2011)
IEC/EN 62109-1:2010,
UL1741(2ndEdition, January28, 2010)
Low Voltage Directive 2014/35/EU



上圖:日煬Nakornsawan 126.26MW實績

下圖:日煬Lampang 128.396MW實績





擁有國際 4 大認證 **cTUVus, TUV, TAF, CNS, CE**
 (依據 CNS 15426-1、CNS 15426-1:2011、UL 1741:2010、
 C22.2 NO.107.1-01(R2011)、IEC/EN 62109-1:2010、UL1
 741(2ndEdition,January28,2010)、Low Voltage Directive
 2014/35/EU)
 (整組成品定型試驗，含電力、監測、伺服器非空箱，
 定型認證容量 27 迴路 202.5kW/ 箱) **pvBos®**

環境監測箱	_____	02
直流匯流箱 pvBos®	_____	03
箱型介紹 pvBos®	_____	04
直流匯流箱總表 pvBos®	_____	05
直流匯流箱 pvBos®	_____	06-09
高壓單線圖 2000kW	_____	10-11
高壓盤箱型圖	_____	12
JDA 直流匯流箱對應各家廠牌變流器對照表 pvBos®	_____	13

下圖：日煬 Phisanulok 泰國彭世洛 133.92MW 實績



環境監測箱所收集的日照、溫度、風速等數據，可以更精確判斷太陽能電廠的PR值與模組的發電效率，除了掌握電廠的運作狀況外也讓電廠的維運作業有所依據。

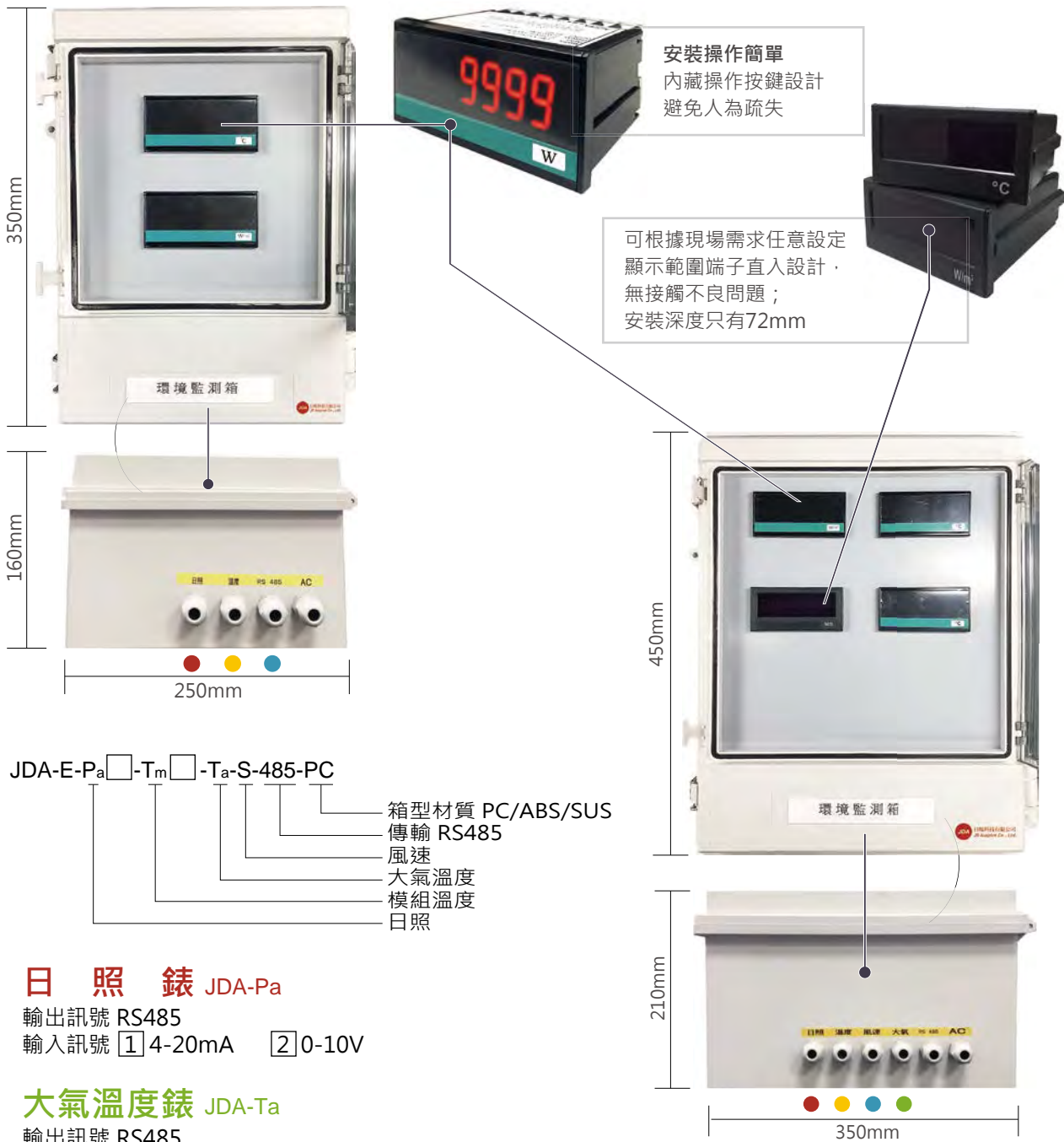

日照錶 JDA-Pa

輸出訊號 RS485
輸入訊號 ① 4-20mA ② 0-10V

大氣溫度錶 JDA-Ta

輸出訊號 RS485
輸入訊號 4-20mA

溫度錶 JDA-Tm

輸出訊號 RS485
輸入訊號 ① 4-20mA ② PT100

風速錶 JDA-S

輸出訊號 RS485
輸入訊號 4-20mA
供應電源 AC115-230V

品名	環境監測箱	
規格	4-20mA	PT100 or 0-10V
日照計	PYRA 03AC	PYRA 03
日照錶	JDA-W/JDA-MD	JDA-W/JDA-PW
溫度錶	JDA-T/JDA-TD4	JDA-T/JDA-TD
風速錶	JDA-S	

註：可另行訂購日照感應器 RS485 輸出 PYRA 03M



TUV 氨氣測試
Ammonia tested cert
CNS 15426-1: 2011
TUV 鹽霧測試證書
Salty mist tested cert

CNS 15426-1
CNS 15426-1:2011
UL 1741:2010
C22.2 NO.107.1-01(R2011)
IEC/EN 62109-1:2010,
UL1741(2ndEdition,January28,2010)
Low Voltage Directive 2014/35/EU

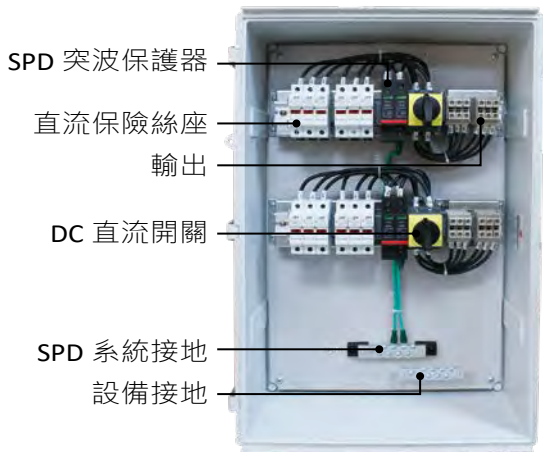

SPD 突波保護器
直流保險絲座
輸出
DC 直流開關
SPD 系統接地
設備接地

6 迴進 6 迴出 pvBos®



4 迴進 4 迴出 pvBos®
進出接線採各組 MPPT 分開配置

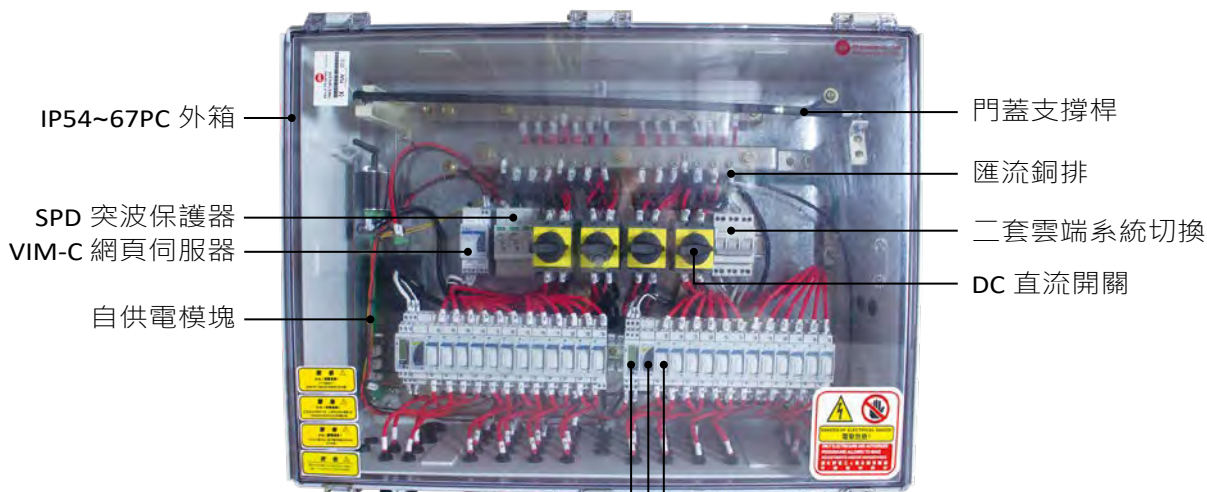

IP54~67PC 外箱
SPD 突波保護器
VIM-C 網頁伺服器
自供電模塊
門蓋支撐桿
匯流銅排
二套雲端系統切換
DC 直流開關

照片：智能匯流箱 24 路、
串列監測、自供電、
無線內置網頁伺服器 pvBos®

VIM-S string unit 1000Vdc,1.5KV optional
串列量測單元
VIM-1 隔離卡
VIM-M master unit
RS 485 資料傳輸單元

* 可外加
VIM-P measuring unit
溫度、日照、風速量測單元

箱體特色：

擁有國際 4 大認證 cTUVus,TUV,TAF CNS,CE
(整組成品定型試驗，含電力、監測、伺服器非空箱，定型認證容量 27 迴路 202.5kW/ 箱)
抗 UV 耐酸鹼抗鹽害防水 IP67 適合安裝場所鹽灘地、水面型系統、戶外屋頂。pvBos®
PC 箱體材質保固 20 年 (限非外力損壞)

設計特色：

一組串列適合一個 MPPT 或一台變流器配置，配線上用最長的距離，減少線路溫升與損失，可單一
串列或最多 6 個串列使用，停機檢修，查修不影響正常組串發電，絕佳的散熱設計。



8 迴進 8 回出 pvBos®



IP54 中門

IP54 箱體



8 迴進 8 迴出 pvBos®

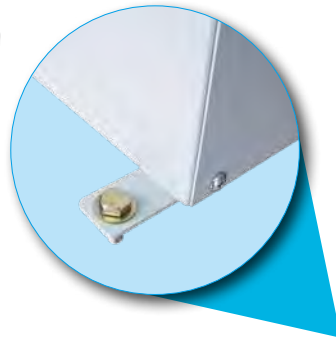

IP65 中門

IP65 箱體



4 迴進 4 迴出 pvBos®

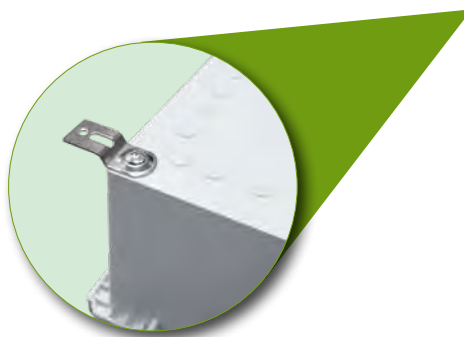

IP67 箱體



6 迴進 6 迴出 pvBos®



Article No: 1001602-2-PC-67

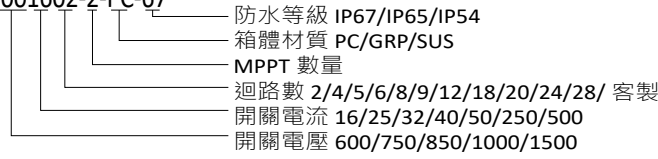

pvBos® 料號	1001602-2-PC-67	1001604-2-PC-67	1001604-1-PC-67 1001606-1-PC-67	1001606-2-PC-67	1001608-2-PC-67	
	1001602-2-SUS-54/65	1001604-2-SUS-54/65	1001604-1-SUS-54/65 1001606-1-SUS-54/65	1001606-2-SUS-54/65	1001608-2-SUS-54/65	
MPPT 數量	2 (1×2)	2 (2×2)	2 (2+3)	2 (3×2)	2 (4×2)	
迴路輸入數	2	4	5	6	8	
迴路輸出數	2	4	5	6	8	
gPV fuse	1,2,4,6,8,12,16,20,25,25,30, on request Up to 630A					
PV Voc	600/750/850/1000/1500					
配盤線徑	4/6/10/16 ~ 240mm²					
PC/GRP 材質 (*ABS/GRP 尺寸另訂)	防水等級	IP67				
	箱體尺寸 (mm)	300×400×150	350×450×200	400×500×200	400×500×200	530×630×255
	進線方式 (選配)	MC4 8*Ø12 電纜固定頭 2*Ø25.4 電纜固定頭 6*Ø25.4	MC4 16*Ø12 電纜固定頭 2*Ø25.4 電纜固定頭 10*Ø25.4	MC4 20*Ø12 電纜固定頭 2*Ø25.4 電纜固定頭 12*Ø25.4	MC4 24*Ø12 電纜固定頭 2*Ø25.4 電纜固定頭 14*Ø25.4	MC4 32*Ø12 電纜固定頭 2*Ø25.4 電纜固定頭 18*Ø25.4
SUS304 材質	防水等級	IP54/IP65				
	箱體尺寸 (mm)	350×500×200	400×500×200	450×500×200	450×500×200	500×500×200
	進線方式 (選配)	MC4 8*Ø12 電纜固定頭 2*Ø25.4 電纜固定頭 6*Ø25.4	MC4 16*Ø12 電纜固定頭 2*Ø25.4 電纜固定頭 10*Ø25.4	MC4 20*Ø12 電纜固定頭 2*Ø25.4 電纜固定頭 12*Ø25.4	MC4 24*Ø12 電纜固定頭 2*Ø25.4 電纜固定頭 14*Ø25.4	MC4 32*Ø12 電纜固定頭 2*Ø25.4 電纜固定頭 18*Ø25.4
	底板	輸出入活動板 (註一：使用輸出入活動板 IP 等級降低)				
certificate	cTUVus,CNS TAF,IAC MRA,TUV,CE					

料號	1001612-2-PC-67	1001606-6-PC-67	1001608-6-SUS-54/65	1001621-1-PC-67	1001628-1-PC-67	
	1001612-2-SUS-54/65	1001606-6-SUS-54/65		1001621-1-SUS-54/65	1001628-1-SUS-54/65	
MPPT 數量	2 (6×2)	6 (3×6)	6 (4×6)	1	1	
迴路輸入數	12	18	24	21	28	
迴路輸出數	12	18	24	21	28	
gPV fuse	1,2,4,6,8,12,16,20,25,25,30, on request Up to 630A					
PV Voc	600/750/850/1000/1500					
配盤線徑	4/6/10/16 ~ 240mm²					
PC/GRP 材質 (*ABS/GRP 尺寸另訂)	防水等級	IP67				
	箱體尺寸 (mm)	630×530×255	830×630×285	630×830×285	630×830×285	
	進線方式 (選配)	MC4 48*Ø12 電纜固定頭 2*Ø25.4 電纜固定頭 26*Ø25.4	MC4 72*Ø12 電纜固定頭 2*Ø25.4 電纜固定頭 38*Ø25.4	MC4 80*Ø12 電纜固定頭 2*Ø25.4 電纜固定頭 42*Ø25.4	MC4 108*Ø12 電纜固定頭 2*Ø25.4 電纜固定頭 56*Ø25.4	
SUS304 材質	防水等級	IP54/IP65				
	箱體尺寸 (mm)	600×500×250	800×700×200	950×700×200	650×850×250	650×850×250
	進線方式 (選配)	MC4 48*Ø12 電纜固定頭 2*Ø25.4 電纜固定頭 26*Ø25.4	MC4 72*Ø12 電纜固定頭 2*Ø25.4 電纜固定頭 38*Ø25.4	MC4 96*Ø12 電纜固定頭 2*Ø25.4 電纜固定頭 50*Ø25.4	MC4 80*Ø12 電纜固定頭 2*Ø25.4 電纜固定頭 42*Ø25.4	MC4 108*Ø12 電纜固定頭 2*Ø25.4 電纜固定頭 56*Ø25.4
	底板	輸出入活動板 (註一：使用輸出入活動板 IP 等級降低)				
certificate	cTUVus,CNS TAF,IAC MRA,TUV,CE					

2 迴直流箱

料號：1001602-2-PC/SUS-67/54/65

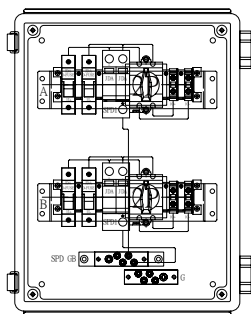

pvBos®

名稱	規格	型號
箱型材質	PC	300×400×150mm
	SUS304	350×500×200mm
突波保護器	20KA I _{max} 40KA DC1KV,1.5KV optional 2P	PV40-1000-MVCR
直流開關	2P 16A 1KV, 1.5KV optional	XBE+0210
Fuse 座	30A 1KV, 1.5KV optional	FH-01L/FH-01
保險絲	16A 10KA/30KA	CH10X38,optionl
接地銅排	4P,4P	

圖碼編號：2 迴直流箱單線圖

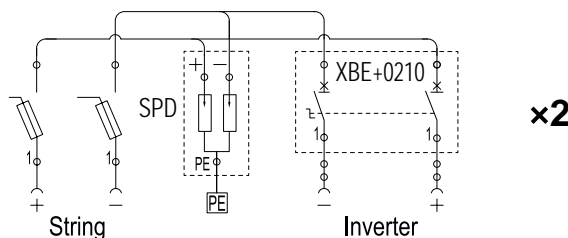

4 迴直流箱

料號：1001604-2-PC/SUS-67/54/65

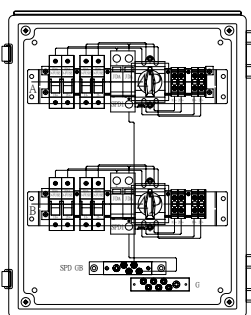

pvBos®

名稱	規格	型號
箱型材質	PC	350×450×200mm
	SUS304	400×500×200mm
突波保護器	20KA I _{max} 40KA DC1KV,1.5KV optional 2P	PV40-1000-MVCR
直流開關	4P 16A 1KV, 1.5KV optional	XBE+0410
Fuse 座	30A 1KV, 1.5KV optional	FH-01L/FH-01
保險絲	16A 10KA/30KA	CH10X38,optionl
接地銅排	4P,6P	

圖碼編號：4 迴直流箱單線圖

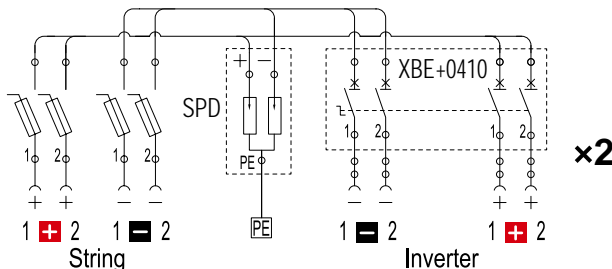

5 迴直流箱

料號：1001604-1-PC/SUS-67/54/65 1001606-1-PC/SUS-67/54/65

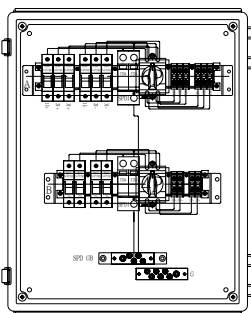

pvBos®

名稱	規格	型號
箱型材質	PC	400×500×200mm
	SUS304	450×500×200mm
突波保護器	20KA I _{max} 40KA DC1KV,1.5KV optional 2P	PV40-1000-MVCR
直流開關	6P/4P 16A 1KV, 1.5KV optional	XBE+0610/XBE+0410
Fuse 座	30A 1KV, 1.5KV optional	FH-01L/FH-01
保險絲	16A 10KA/30KA	CH10X38,optionl
接地銅排	4P,6P	

圖碼編號：5 迴直流箱單線圖

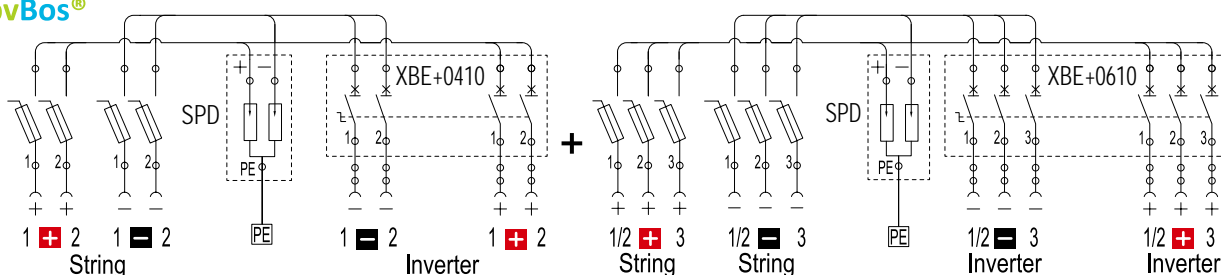

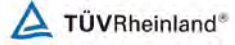

6 迴直流箱

料號：1001606-2-PC/SUS-67/54/65

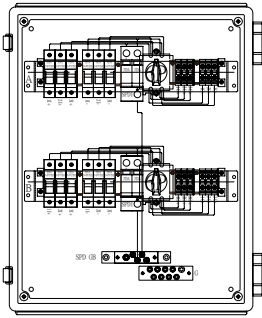

pvBos®

名稱	規格	型號
箱型材質	PC	400×500×200mm
	SUS304	450×500×200mm
突波保護器	20KA I _{max} 40KA DC1KV,1.5KV optional 2P	PV40-1000-MVCR
直流開關	6P 16A 1KV, 1.5KV optional	XBE+0610
Fuse 座	30A 1KV, 1.5KV optional	FH-01L/FH-01
保險絲	16A 10KA/30KA	CH10X38,optionl
接地銅排	4P,8P	

圖碼編號：6 迴直流箱單線圖

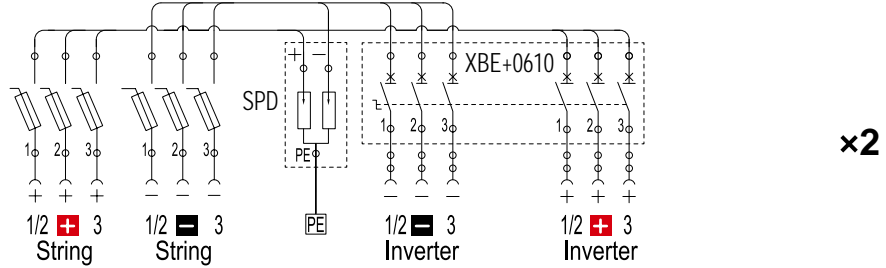

8 迴直流箱

料號：1001608-2-PC/SUS-67/54/65

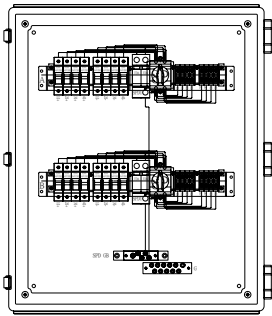

pvBos®

名稱	規格	型號
箱型材質	PC	530×630×255mm
	SUS304	500×500×200mm
突波保護器	20KA I _{max} 40KA DC1KV,1.5KV optional 2P	PV40-1000-MVCR
直流開關	8P 16A 1KV, 1.5KV optional	XBE+0810
Fuse 座	30A 1KV, 1.5KV optional	FH-01L/FH-01
保險絲	16A 10KA/30KA	CH10X38,optionl
接地銅排	4P,10P	

圖碼編號：8 迴直流箱單線圖

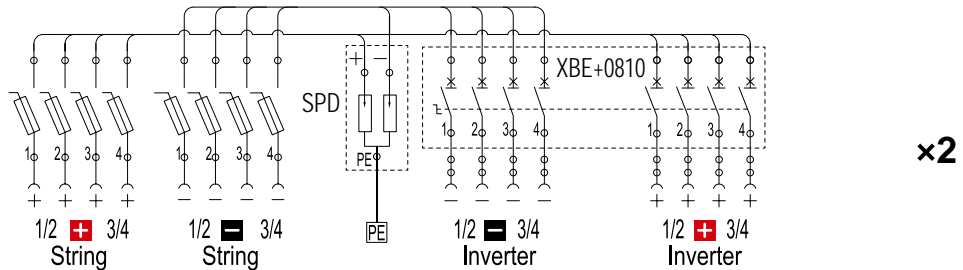

12 迴直流箱

料號：1001612-2-PC/SUS-67/54/65

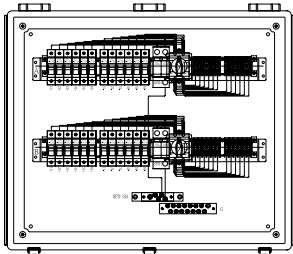

pvBos®

名稱	規格	型號
箱型材質	PC	630×530×255mm
	SUS304	600×500×250mm
突波保護器	20KA I _{max} 40KA DC1KV,1.5KV optional 2P	PV40-1000-MVCR
直流開關	12P 16A 1KV, 1.5KV optional	XA100.16DL12E-A
Fuse 座	30A 1KV, 1.5KV optional	FH-01L/FH-01
保險絲	16A 10KA/30KA	CH10X38,optionl
接地銅排	4P,14P	

圖碼編號：12 迴直流箱單線圖

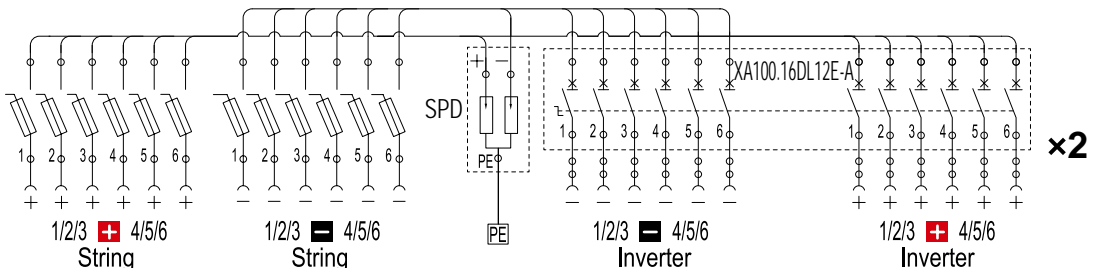

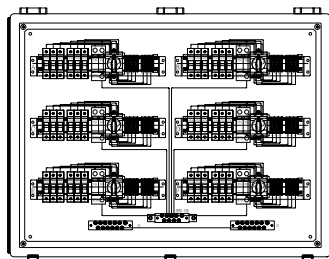

pvBos®

18 迴直流箱

料號：1001606-6-PC/SUS-67/54/65

名稱	規格	型號
箱型材質	PC	830×630×285mm
	SUS304	800×700×200mm
突波保護器	20KA I _{max} 40KA DC1KV, 1.5KV optional 2P	PV40-1000-MVCR
直流開關	6P 16A 1KV, 1.5KV optional	XBE+0610
Fuse 座	30A 1KV, 1.5KV optional	FH-01L/FH-01
保險絲	16A 10KA/30KA	CH10X38, optional
接地銅排	8P, 12P	

圖碼編號：18 迴直流箱單線圖

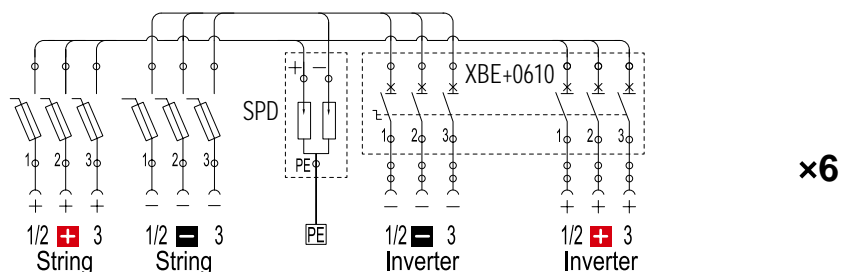

24 迴直流箱

料號：1001608-6-SUS-67/54/65

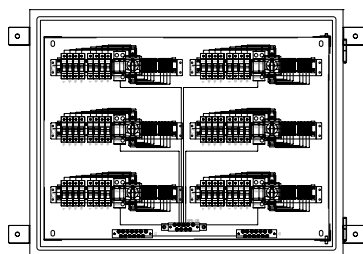

pvBos®

名稱	規格	型號
箱型材質	SUS304	950×700×200mm
突波保護器	20KA I _{max} 40KA DC1KV, 1.5KV optional 2P	PV40-1000-MVCR
直流開關	8P 16A 1KV, 1.5KV optional	XBE+0810
Fuse 座	30A 1KV, 1.5KV optional	FH-01L/FH-01
保險絲	16A 10KA/30KA	CH10X38, optional
接地銅排	8P, 12P	

圖碼編號：24 迴直流箱單線圖

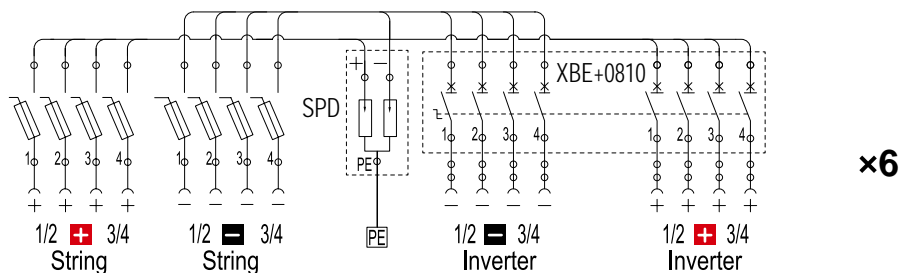

20 迴直流箱

料號：1001621-1-PC/SUS-67/54/65

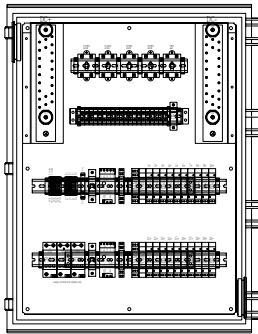

pvBos®

名稱	規格	型號
箱型材質	PC	630×830×285mm
	SUS304	650×850×250mm
突波保護器	20KA I _{max} 40KA DC1KV,1.5KV optional 2P	PV40-1000-MVCR
直流開關	10P 16A 1KV, 1.5KV optional	XA100.16DL10E-A
Fuse 座	30A 1KV, 1.5KV optional	FH-01L/FH-01
保險絲	16A 10KA/30KA	CH10X38,optionl
接地銅排	22P	

圖碼編號：20 迴直流箱單線圖

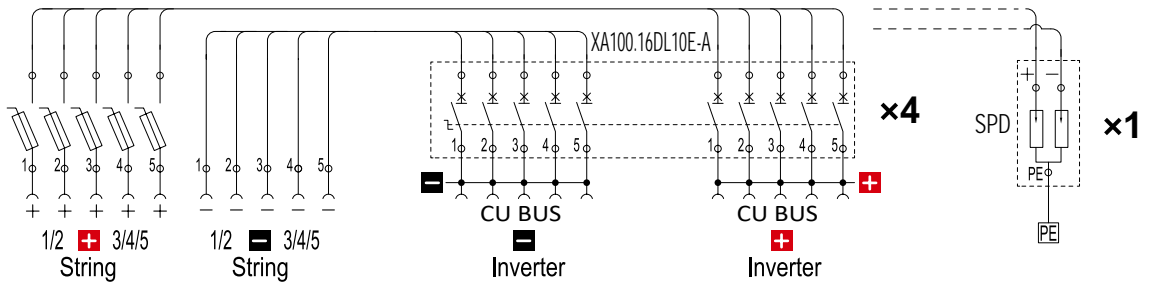

28 迴直流箱

料號：1001628-1-PC/SUS-67/54/65

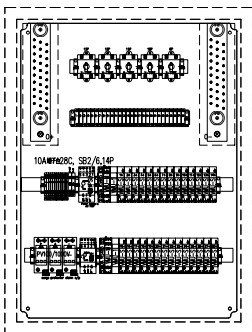

pvBos®

名稱	規格	型號
箱型材質	PC	630×830×285mm
	SUS304	650×850×250mm
突波保護器	20KA I _{max} 40KA DC1KV,1.5KV optional 2P	PV40-1000-MVCR
直流開關	8P/12P 16A 1KV, 1.5KV optional	XBE+0810/XA100.16DL12E-A
Fuse 座	30A 1KV, 1.5KV optional	FH-01L/FH-01
保險絲	16A 10KA/30KA	CH10X38,optionl
接地銅排	30P	

圖碼編號：28 迴直流箱單線圖

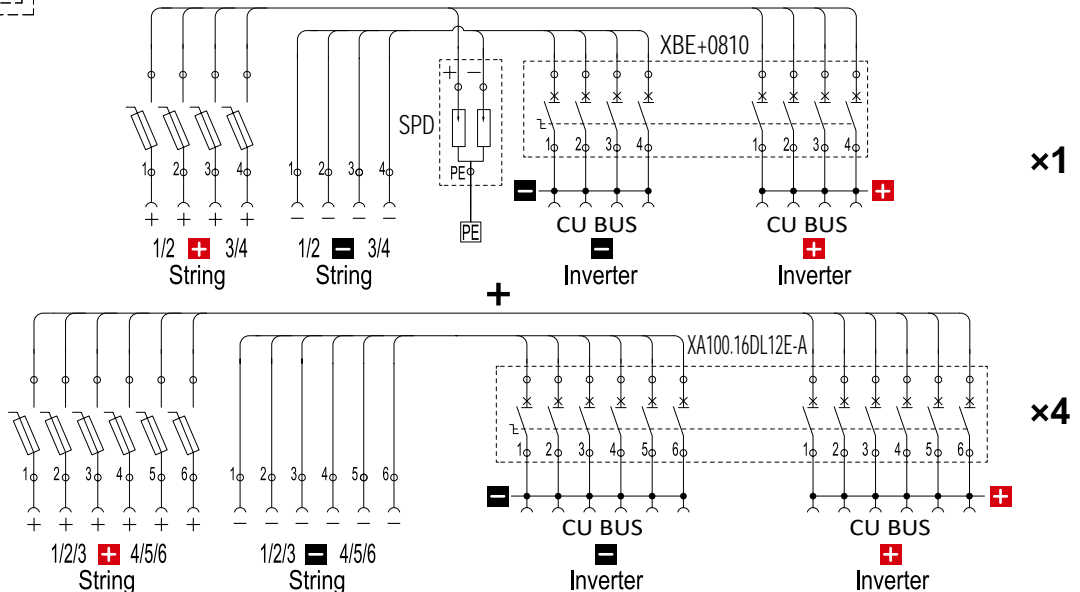

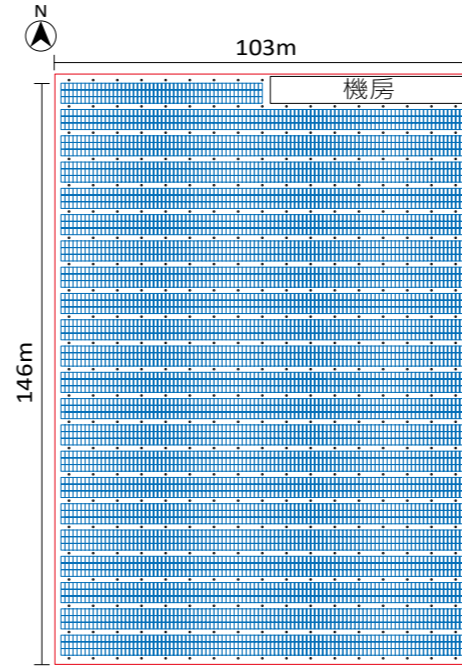
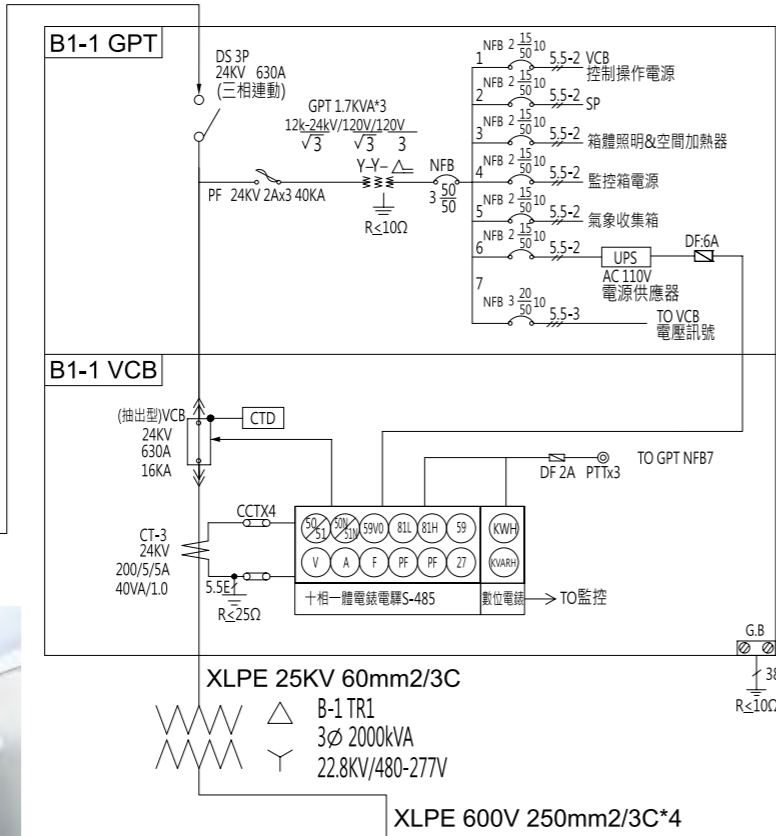
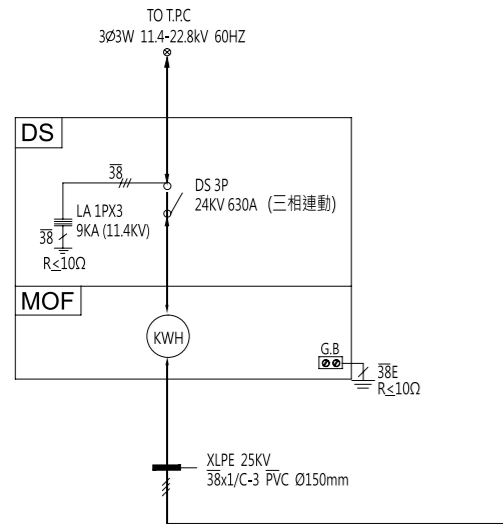

設置容量 2000kW
最大發電 1964.16kW (310W × 6336)
電池數量 6336 片
傾斜角度 12°
設置面積 15097m²



DS MOF GPT VCB TR MP



12 迴直流箱



Inverter
Growatt MAX 80000 TL3-H

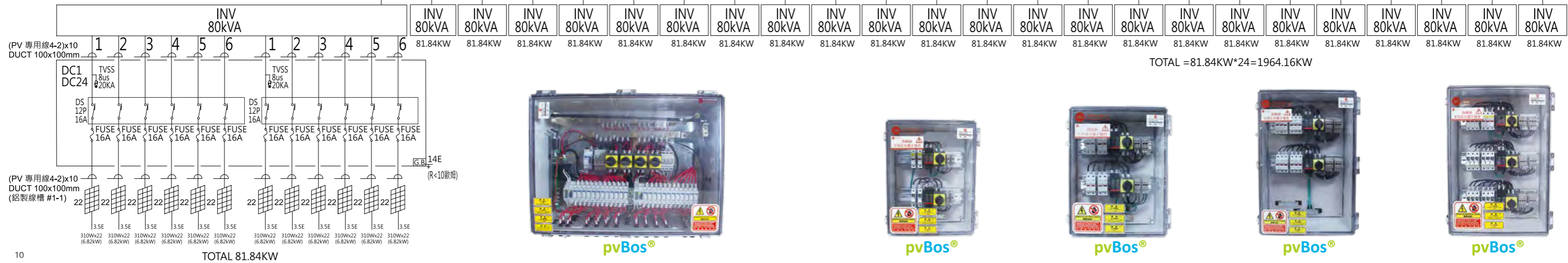
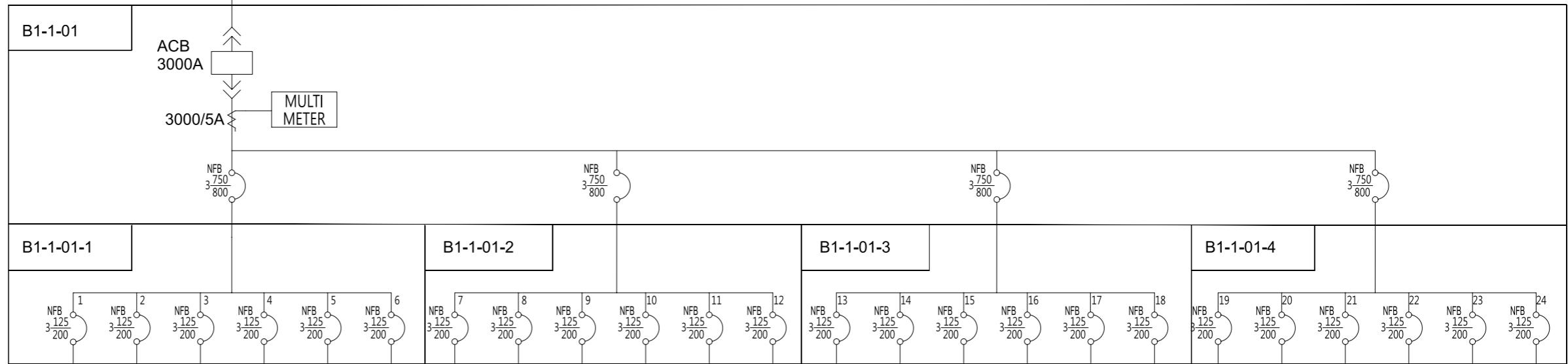

pvBos®



pvBos®



pvBos®



pvBos®



pvBos®

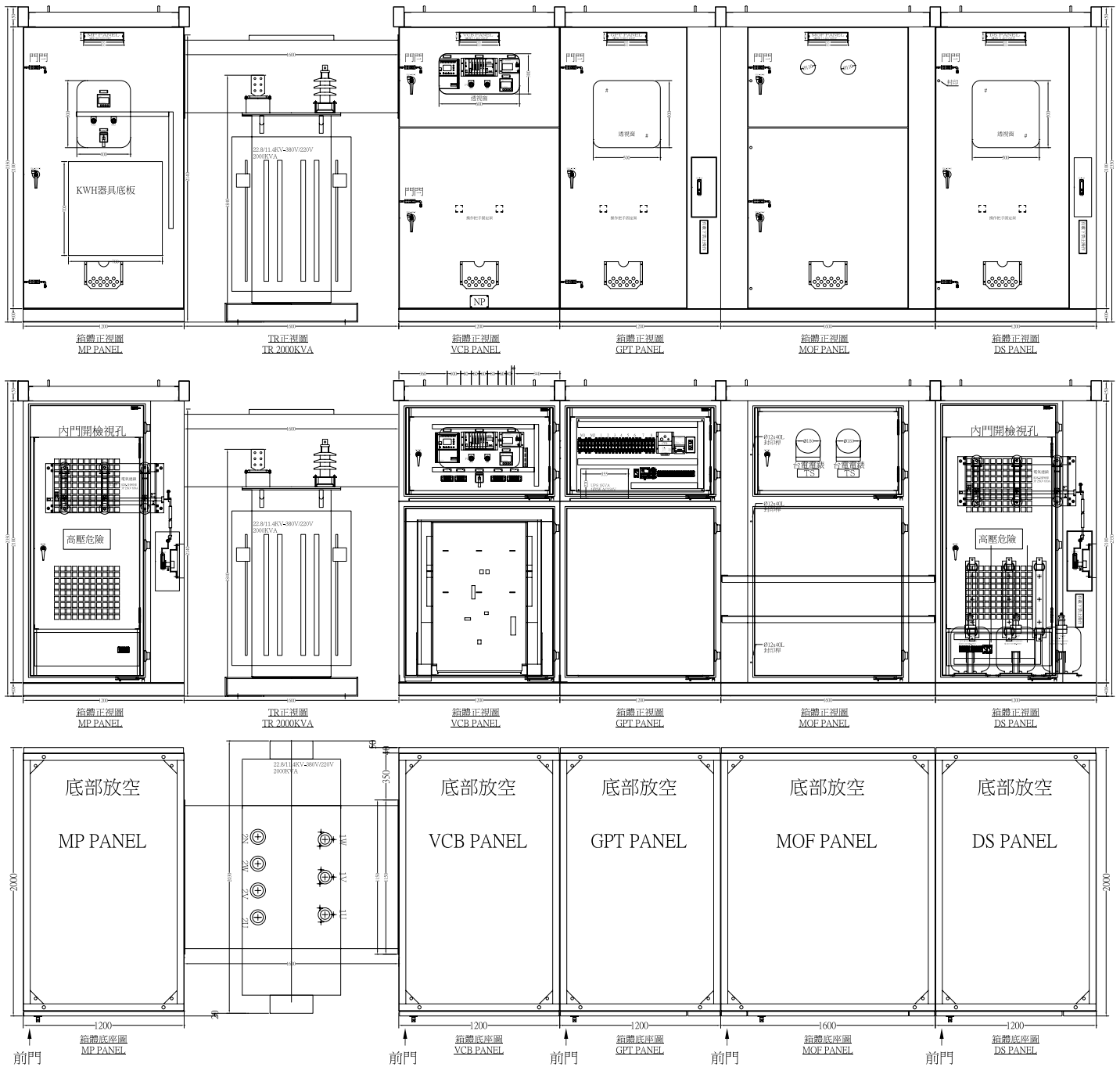

箱體前門連結圖及平面配置圖





變流器廠牌	變流器型號	額定功率 (W)	JDA 直流匯流箱	
			料號	頁碼
ABB	Trio-20.0-TL-OUTD-400	20000	1001604-2	06
	Trio-20.0-TL-OUTD-S2-400	20000		
	Trio-20.0-TL-OUTD-S2F-400	20000		
	Trio-20.0-TL-OUTD-S2X-400	20000		
	Trio-27.6-TL-OUTD-400	27600		
	Trio-27.6-TL-OUTD-S2-400	27600		
	Trio-27.6-TL-OUTD-S2F-400	27600		
	Trio-27.6-TL-OUTD-S2X-400	27600		
	TRIO-50.0-TL-OUTD	50000	1001608-2	07
	TRIO-TM-50.0-400	50000		
	TRIO-60.0-TL-OUTD-480	60000	1001612-2	07
	TRIO-TM-60.0-480	60000		
	PVS-100-TL	100000	1001608-6	08
	PVS-120-TL	120000		
Ablerex	ES 10000	10000	1001604-2	06
	ES 12000	12000	1001604-4	客製
	ES 25600 HC	25600		
	ES 52000 HC	52000	1001604-3/1001602-1	客製
	ES 60000 HC	60000	1001604-3/1001602-1	客製
Cyberpower	CPSPV10000ETL	10000	1001602-2	06
	CPSPV12000ETL	12000		
	CPSPV15000ETL-S	15000		
	CPSPV20000ETL	20000		
	CPSPV33000ETL	33000	1001604-1/1001606-1	06
	CPSPV50000ETL-WB	50000	1001606-3	08
DELTA	RPI-M15	15000	1001602-2	06
	RPI-M15A	15000		
	RPI-M20	20000		
	RPI-M20A	20000		
	RPI-M30	30000	1001606-2	07
	RPI M30A_121	30000		
	RPI M50A_120	50000	1001608-2	07
	RPI M50A_12s	50000		
	M88H_121	80000	1001612-2	07
M88H_122	80000			
GOODWE	GW10K-DT	10000	1001602-2	06
	GW10KN-DT	10000		
	GW15K-DT	15000		
	GW15KN-DT	15000		
	GW20K-DT	20000		
	GW25K-DT	25000	1001604-1/1001602-2	客製
	GW50K-MT	50000	1001604-4	客製
	GW60K-MT	60000	1001606-4	客製
GROWATT	GROWATT 10000 UE	10000	1001602-2	06
	GROWATT 12000 UE	12000		
GROWATT	GROWATT 30000TL3-S	30000	1001604-1/1001606-1	06
	GROWATT 33000TL3-S	33000		
	GROWATT 40000TL3-NS	40000	1001606-2	07
	GROWATT 50000TL3-S	50000	1001608-1/1001606-1	客製
	GROWATT MAX60KTL3 H	60000	1001604-4/1001602-2	客製
	GROWATT MAX70KTL3 H	70000		
	GROWATT MAX80KTL3 H	80000	1001612-2	07

(以上型號僅供參考)



變流器廠牌	變流器型號	額定功率 (W)	JDA 直流匯流箱	
			料號	頁碼
Huawei	SUN2000-12KTL	12000	1001602-2	06
	SUN2000-17KTL	17000	1001602-3	客製
	SUN2000-20KTL	20000		
	SUN2000-33KTL	30000	1001604-2	06
	SUN2000-40KTL	36000		
	SUN2000-36KTL	36000		
	SUN2000-42KTL	42000	1001606-2	07
	SUN2000-60KTL-M0	60000	1001608-2	07
	SUN2000-65KTL-M0	65000		
KACO	Blueplanet 20.0 TL3 M2 WM OD IIG0	20000	1001604-2	06
KSTAR	KSG-10K	10000	1001602-2	06
	KSG-20K	20000		
	KSG-30K	30000	1001604-1/1001606-1	06
	KSG-50K	50000	1001608-2	07
POWER MASTER	PM-12000GT	12000	1001602-2	06
PrimeVOLT	PV-10000T-U	10000	1001602-2	06
	PV-15000T-U	15000		
	PV-20000T-U	20000	1001602-1/1001604-1	客製
	PV-30000T-U	30000	1001604-2	06
	PV-40000T-U	40000	1001606-2	07
Schneider	Conext CL-60E	60000	1001610-2	客製
SMA	STP 25000TL-30	25000	1001604-2	06
	STP 50-40	50000	1001602-4/1001604-2	客製
	SHP75-10	75000	1001604-4/1001602-2	客製
Solaredge	SE10K	10000	1001602-2	06
	SE12.5K	12500		
	SE15K	15000	1001602-3	客製
	SE16K	16000		
	SE17K	17000		
	SE25K	25000	1001602-4	客製
	SE27.6K	27600		
	SE33.3K	33000	1001602-5	客製
	SE55K	55000	1001602-8	客製
	SE66.6K	66600	1001602-10	客製
	SE82.8K	82800	1001602-12	客製
SE100K	100000	1001602-13	客製	
SOLARX POWER	X3-10.0-T	10000	1001602-2	06
	ZDNY-TL10000	10000		
	ZDNY-TL12000	12000		
	ZDNY-TL15000	15000		
	ZDNY-TL17000	17000		
	ZDNY-TL20000	20000	1001604-2	06
	X3-30T	30000		
SUNGROW	SG33KTL-M	33000	1001604-2/1001602-1	客製
	SG36KTL-M	36000	1001604-3	客製
	SG60KTL	60000	1001610-2	客製
	SG80KTL-M	80000	1001608-2	07

(以上型號僅供參考)



日煬科技有限公司
JD Auspice Co., Ltd.



上圖:日煬Lopburi 9.6MW實績



下圖:日煬Lampang 128.396MW實績