



日燭科技有限公司  
JD Auspice Co., Ltd



# 綜合型錄

## Products Brochure

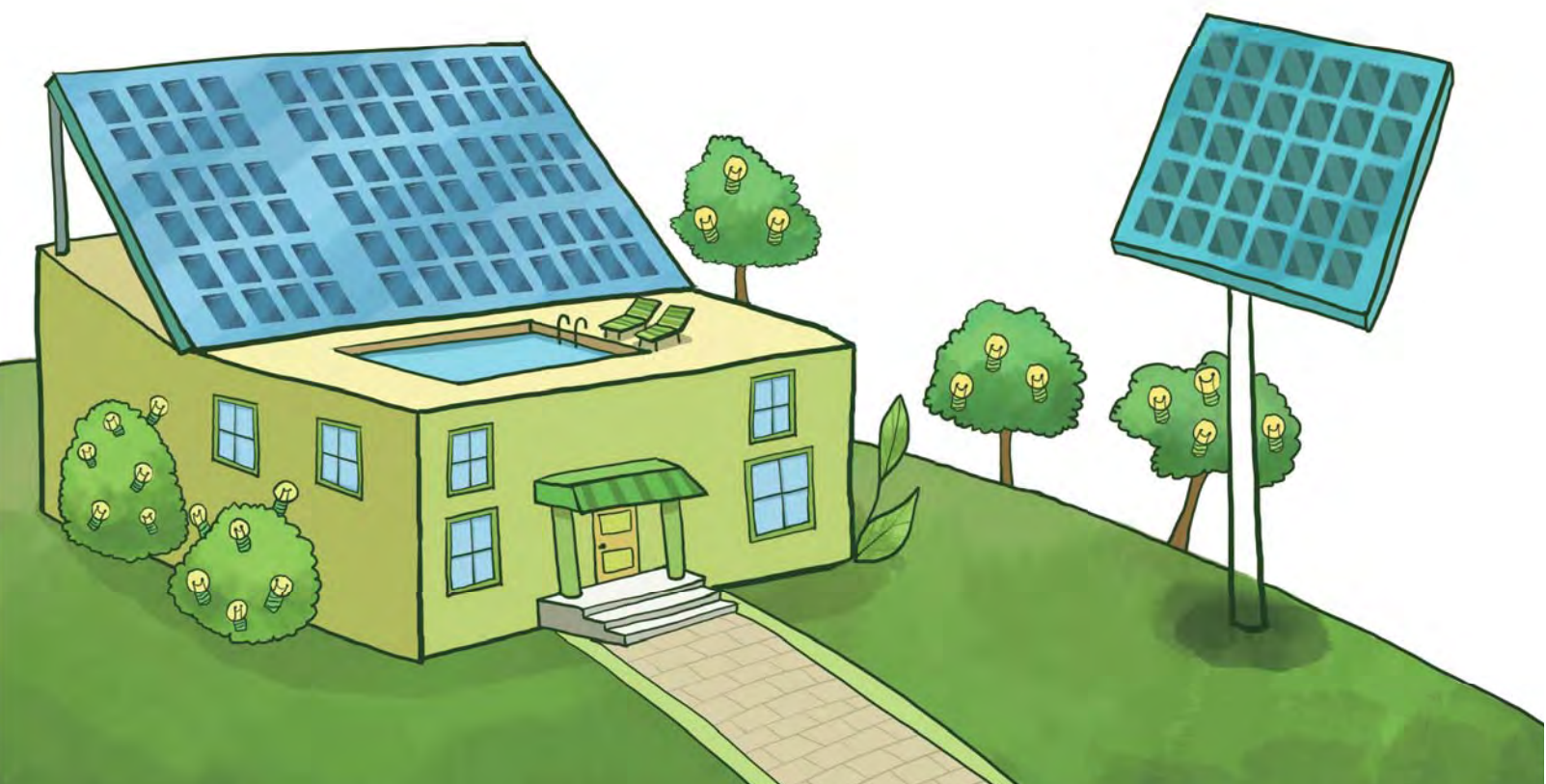





1. 太陽能應用示意圖 Application scheme .....	p4
2. 環境監測系列 Environmental sensors .....	p5
3. 太陽能直流組件系列 Solar BOS series .....	p6
4. 太陽能發電監測系列 PV firm Monitoring system .....	p7
5. 直交流突波吸收器 DC/AC Surge protection device .....	p8-p9
6. 突波測試器、訊號雷擊計數器、訊號突波保護器 SPD testing instrument,Lightning even counter, Network protector .....	p10
7. 直流開關箱 pvBos <sup>®</sup> PV array Combiner Box .....	p11
8. IP65/66/67 防水箱 IP65/66/67 Enclosure .....	p12
9. 太陽能串列監測 stringMoni <sup>®</sup> Strings monitoring system .....	p13
10. 太陽能消防安全開關系列 FFS Safety Switch .....	p14
11. 直流故障電弧斷路器 DC arc fault interrupter .....	p15
12. 接地故障保護裝置 Ground-Fault protection .....	p16
13. 直流開關 DC Switch disconnect (XA type /X type / P-type) .....	p17-p22
14. 直流斷路器 DC MCCB for DC Application .....	p23-24
15. 最大功率追蹤器 MppGuard, Max. power point tracker .....	p25

太陽能發電用直流平衡系統組件供應商

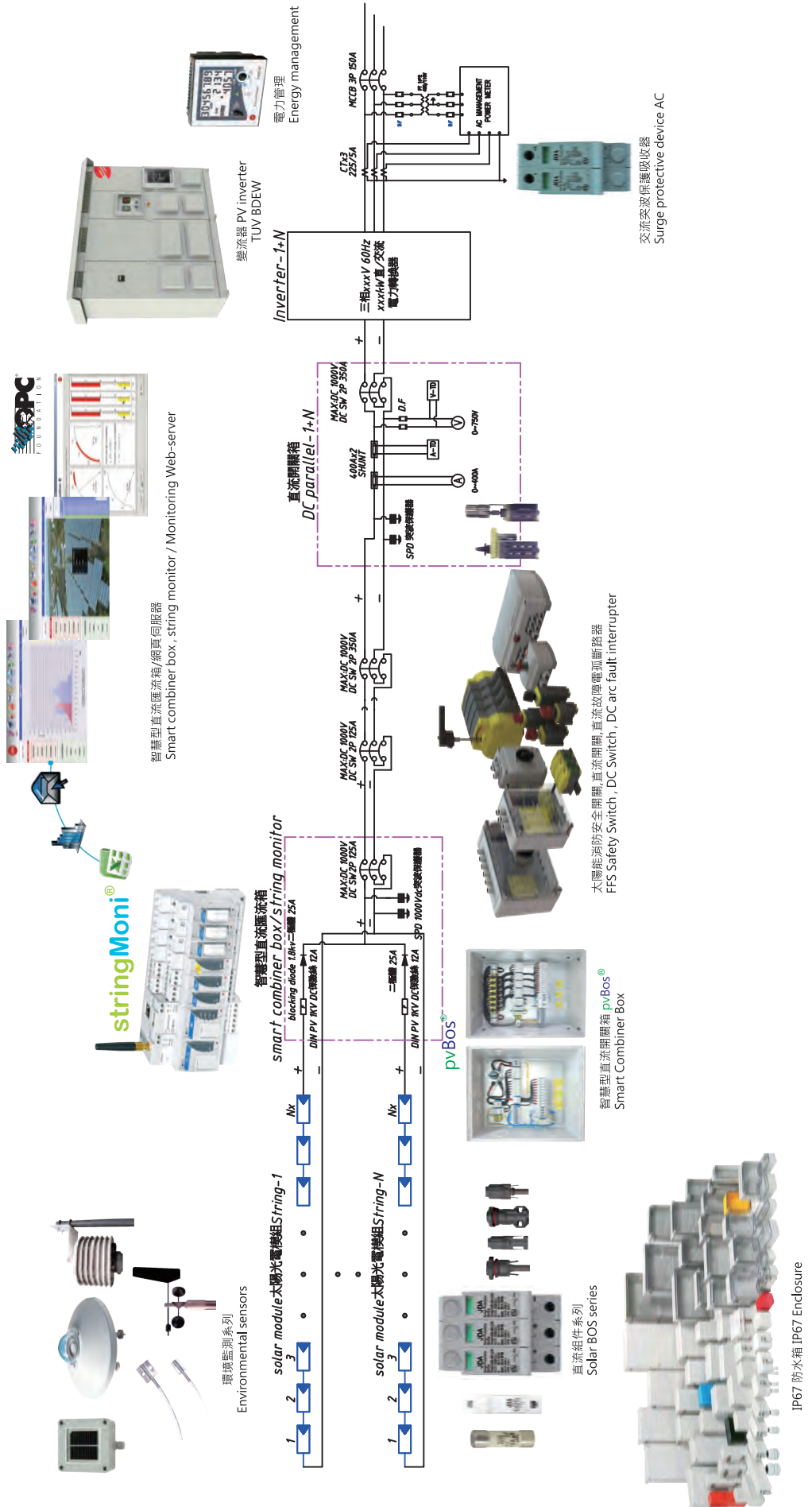



### Pyranometer

#### 日照計 LP 03/03AC/Pyrsi-03 矽晶日照計

Typical sensitivity : 10MV/(W/m<sup>2</sup>), output : 4-20mA, Measuring range : 0 ~ 2000W/m<sup>2</sup>, Operating temperature: -40°C ~ 60°C, Fully comply with ISO 9060 second class standards.

全天空輻射計：ISO 9060 等級II · 量測範圍0-2000W/M<sup>2</sup> · 輸出4-20mA · 操作溫度-40~+60°C · 反應<30秒。



### Portable pyranometer

#### 攜帶型日照計 LP 471 + Pyra 03.5

Type : LP 471 PYRA 03.5 + HD2302, Typical sensitivity : 10MV/(W/m<sup>2</sup>), Spectral field : 305nm ~ 2800nm, Measuring range : 0 ~ 2000W/m<sup>2</sup>, Viewing field : 2πsr, Operating temperature : -40°C ~ 80°C, Fully comply with ISO 9060 second class standards.

靈敏度：10uA/(W/m<sup>2</sup>) · 光譜範圍：305nm ~ 2800nm · 量測範圍：0 ~ 2000W/m<sup>2</sup>, 監測角度：2πsr · 工作溫度：-40°C ~ 80°C · 符合ISO9060 second class 標準。



### SolmoTemp / Solar module surface temperature sensor

#### 薄片型溫度感測器 TS-01

PT100 3 wire surface temperature sensor for solar module temperature sensing.

厚度3mm × 長50mm × 寬50mm · 線長 1.5~3米(長度另可客製) · 量測範圍：20°C ~ 150°C · 輸入型式3 wire PT100。



### Data Network Protector for high-frequency signal transmission

#### 戶外型溫溼度信號傳送器TS-3200

Measuring range : 0~100%RH, -40~+100°C, output : 4-20mA two wire, power : 12-36VDC > 150mA, ingress protection : IP65.

測量範圍：0~100%RH, -40~+100°C · 訊號輸出：4-20mA two wire · 電壓供給：12-36VDC > 150mA · 防護等級：ABS 耐候外殼 IP65。



### Wind speed and Direction

#### 風速風向計DNxxx#C

Wind speed : 0-60m/s, Wind direction : 0-360°.

風速計：0-60m/s · 風向計：0-360°。





### Fuse holder 900Vdc / 1000Vdc 直流保險絲座 FH-01

直流熔絲座：1000Vdc 32A，操作度-20 ~ +70C, IEC60947-1/3  
適用直流保險絲：900Vdc (900Vdc, Tested 1000Vdc) 1,2,4,6,8,10,12,16, 20,25,30A 10x38mm。



### PV fuse link 直流保險絲

直流保險絲：900Vdc tested 1000Vdc：1,2,4,6,8,10,12,16,20,25,30A, 10 x 38mm.  
1000Vdc：1,2,4,6,8,10,12,16,20,25A, 10 x 38mm.  
1000Vdc：1,2,4,6,10,16,20,25,32,40,50, 22 x 127 mm, 50KA  
IEC60269-6。



### DC arc fault interrupter 太陽能直流電弧偵測

DC arc fault interrupter, in according to NEC690, Detects fast current changes within the solar power plant, as they are caused by arcs and generates an electrical signal. The electrical signal can be individually processed, message, siren motor-switch or relay contact (active fire safety). Combinable with other products. DIN rail mount in combiner box, or PCB box. 測試標準依據UL1699B(DC專用為UL1699B,(非AC的UL1699, 二者不同)偵測同極串聯、二個反極性之間、同極併聯或對地之間的併聯電弧故障。與消防安全開關內置電弧偵測或與直流系統絕緣監測器或模組短路開關一起配置。長期監測因接線未牢固，風壓震動導致接觸鬆動，或電纜絕緣老化產生電弧而發生火災。

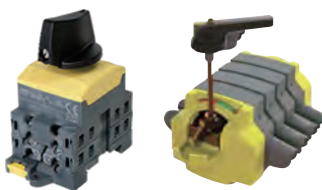

### DC Switch disconnect 直流開關 XA type / X type

16~2000Amp, 600-1000Vdc, Passed UL.IEC.KEMA.CE.BC.CSA.CC safety standard.  
16~2000Amp · 600-1000Vdc · 通過UL、IEC、KEMA、CE、BC、CSA、CCC認證，雙軸非同步儲能驅動，雙刀圓盤接點橋，無伸張電弧，可安全的直接電壓下使用，自我清潔接點，高速氣流冷卻技術，符合國際環保規定，不含鉛鎘，體積小，多種安裝選擇。



### DC MCCB / DC Switch 直流漏電斷路器

DC MCCB：500~1000V, 16~2000A, DC Switch：500~1000V, 16~2000A · TUV  
直流斷路器：500~1000V, 16~2000A。  
直流開關：500~1000V, 16~2000A · TUV認證。

### VIM-M master unit RS 485資料傳輸單元



Master communication capability. RS485 communication port (Modbus). Local communication bus management up to 15 mixed VIM-S, VIM-P and VIM-O unit. Two digital inputs. Two temperature inputs: PT100 or PT1000. Single virtual or real alarm set-point connectable to any available variable. Data and event stamping system Display readout: 6 DGTs. 12 to 28 VDC power supply. IP40, DIN module.

RS485資料傳輸單元：可接15個介面·2個數位輸入·2個溫測輸入Pt100 or 1000·-50~+200°C·3 wire·0.1°C/0.1°F·±0.5%RDG·六位數顯示個別單串之電流、電壓、功率·加總由RS485輸出·RS485 multi-drop雙向·2 wire 1000M·247位置選擇·自動位址·擷取VIM-S, VIM-P, VIM-O 訊息如：防盜、保險絲熔斷、PV接線問題·PV逆向電壓暨極性、電流、電壓、功率、日照、風速、開關或避雷狀態·自動清洗或遙控·IP40 DIN rail mount。

### VIM-S string unit 1000Vdc 串列量測單元



Direct DC voltage measurement up to 1000V, Energy measurements : kWh. Direct DC current measurement up to 16A or up to 30A without fuse. Instantaneous variables data format : 4 DGTs. Energies data format : 6 DGT Instantaneous variables : V, A, W. Accuracy : Class 1 (kWh) ±0.5 RDG (current/voltage) Auxiliary power supply from VIM-M unit String alarm management by means of VIM-M unit only. Fuse blow detection by means of VIM-M unit only. PV module connection control by means of VIM-M unit only. Integrated 10.3x38mm fuse holder for string protection. IP40, DIN module.

串列即時量測單元：KWH, V, A, W保險絲熔斷·PV接線問題·PV逆向電壓暨極性·電壓等級DC1000V·直測DC直流16A或30A·Continuous overload 1100 Vdc, for 500ms 1600Vdc, to earth 800Vdc, 內置10.3\*38mm fuse座·IEC60269-1·不含fuse·IP40 DIN rail mount。

### VIM-P measuring unit 溫度、日照、風速量測單元



Measurements : PV module temperature, air temperature, sun irradiation, wind speed. Two temperature inputs : Pt100 or Pt1000. One 120mV or 20mA DC input with scaling capability for irradiation measurement. One pulse input for wind speed measurement. Auxiliary communication bus to VIM-M unit. Auxiliary power supply from VIM-M unit. IP40, DIN module.

溫度、日照、風速量測單元：溫度 one module Temp. input, one air Temp. input, Pt 100 or 1000, -50~+200°C·3 wire·0.1°C/0.1°F·±0.5%RDG·日照一個輸入·解析1W/M<sup>2</sup>·0~120mVDC±0.2%·風速一個輸入·誤差±0.02%·0-1000HZ·IP40 DIN rail mount。

### VIM-O input / output unit 輸出入單元



Expansion I/O module (digital inputs and outputs). Two relay outputs managed by the VIM-M module. Two digital inputs managed by the VIM-M module. Auxiliary power supply from VIM-M module. IP40, DIN module.

輸出入單元：由VIM-M主控二個relay輸出警報·光伏板效率改變時內建時鐘定時或遙控驅動清洗模板·二個數位輸入·偵測開關開路、閉路·避雷保護狀態經RS485傳送。

### stringMoni<sup>®</sup> sever stringMoni<sup>®</sup> 網路伺服器



Four RS485 ports, three USB 2.0 ports, one ethernet ports, 100 to 240VAC power supply, Wall/DIN-rail mounting type. Plant information, plant map for failure localization, webcam management, Real-time display with alarm indication, Graphical and analytical yield trends, Alarm and events logging.

四個RS485資料傳輸埠·三個USB2.0埠·一個乙太網路埠·電源100~240VAC·壁掛式·DIN導軌安裝·電廠信息·電廠圖示故障位址·網路攝影管理·即時顯示警告指示·圖形分析收益趨勢圖·警報和事件記錄。

### PSU18W 電源供應卡



PSU24181, input AC 90~265Vac DC 120~370Vdc, output 24VDC 18W  
Din-rail power supply.



**DC Surge protection device**  
**直流突波吸收器 600VDC**

Nominal voltage 600Vdc, In 10-70KA, I<sub>max</sub> 25-150KA, IEC61643-11:2005, UL1449 ed. 3 with aux. relay output.  
PV 40/600 直流突波吸收器：600Vdc, In 10-70KA, I<sub>max</sub> 25-150KA, IEC61643-11:2005, UL1449 ed.3。



**DC Surge protection device**  
**直流突波吸收器 1000VDC**

Nominal voltage 1000Vdc, In 20-40KA, I<sub>max</sub> 40-80KA, IEC61643-11:2005, UL1449 ed. 3 with aux. relay output.  
PV 40/1000 直流突波吸收器：1000Vdc, In 20-40KA, I<sub>max</sub> 40-80KA, IEC61643-11:2005, UL1449 ed.3。



**DC Surge protection device**  
**直流突波吸收器 1000VDC**

Nominal voltage 1000Vdc, In 50KA, I<sub>max</sub> 100KA, IEC61643-11:2005, UL1449 ed. 3 with aux. relay output. 10/350us 12.5KA, 8/20us 100KA.  
PV 100/1000 直流突波吸收器：1000Vdc, In 50KA, I<sub>max</sub> 100KA, IEC61643-11:2005, UL1449 ed.3, 10/350μs 12.5KA, 8/20μs 100KA, Class I+II/B+C, VPR < 3.2KV。



**DC/AC Surge protective devices**  
**直流交流突波吸收器 D1-100/\*\*\*-2MVGT-R**

直流交流雙相突波保護器：最大連續使用電壓420~560Vdc · 最大放電電流100KA · 突波保護等級1.6KV · 無洩漏及無續流電流 · DIN導軌安裝模組化設計 · 模塊插拔更換 · 熱保護脫扣設計 · 內建滅弧裝置 · 紅色落牌故障警示 · 常開長閉故障信控輔助接點。  
Single phase power supply system, AC and DC application 420 to 560V, max. discharge current 100KA Inbuilt Arc-extinguishing device, high energy MOV and GTD hybrid unit inside Im 100KA, Vp up 0.5 to 1.6KV at 3KA, no leakage current, DIN rail mounting, modular design, red sign fault indication, remote aux. relay 1NO 1 NC.



**DC/AC Surge protective devices**  
**直流交流突波吸收器 D1-40/\*\*\*-2MV-R**

直流交流單相突波保護器：最大連續使用電壓75~800Vdc · 最大放電電流40KA · 突波保護等級0.3~2.0KV · 無洩漏電流 · DIN導軌安裝模組化設計 · 模塊插拔更換 · 熱保護脫扣設計 · 內建滅弧裝置 · 紅色落牌故障警示 · 常開長閉故障信控輔助接點。  
Single phase power supply system, max.discharge current 40KA, MCOV from 75 to 800Vdc, Inbuilt Arc-extinguishing device, Im 40KA, Up 0.3 to 2.0KV, no leakage current, DIN rail mounting, modular design, red sign fault indication, remote aux. relay 1NO 1 NC.





## DC/AC Surge protective devices 直流交流突波吸收器 D1-100/\*\*\*-2VG-R

直交流單相突波保護器：複合型變阻與氣體放電管技術，最大連續使用電壓MCOV150~800Vac/dc，高放電能量class I/12.5KA class II/50KA，適合戶外一級雷及戶內二級雷應用，突波保護等級0.5~1.6KV/3KA，無洩漏電流，DIN導軌安裝模組化設計，模塊插拔更換，熱保護脫扣設計，內建滅弧裝置，紅色落牌故障警示，常開長閉故障信控輔助接點。

Single phase power supply system, AC and DC application 150 to 800V, max. discharge current 50KA class II, 12.5KA class I, Inbuilt Arc-extinguishing device, high energy MOV and GTD hybrid unit inside Imax 100KA, Vp up to 1.6KV at 3KA, no leakage current, DIN rail mounting, modular design, red sign fault indication, remote aux. relay 1NO 1 NC.



## DC/AC Surge protective devices 直流交流突波吸收器 D3-40/\*\*\*-4MV-R

直交流三相突波保護器：最大連續使用電壓75~800Vdc，最大放電電流40KA，突波保護等級0.3~2.0KV，無洩漏電流，DIN導軌安裝模組化設計，模塊插拔更換，熱保護脫扣設計，內建滅弧裝置，紅色落牌故障警示，常開長閉故障信控輔助接點。

Three phase power supply system, max. discharge current 40KA, MCOV from 75 to 800Vdc, Inbuilt Arc-extinguishing device, Imax 40KA, Up 0.3 to 2.0KV, no leakage current, DIN rail mounting, modular design, red sign fault indication, remote aux. relay 1NO 1 NC.



## DC/AC Surge protective devices 直流交流突波吸收器 D3-100/\*\*\*-4MVGT-R

直交流三相突波保護器，最大連續使用電壓150~800Vdc，最大放電電流100KA，突波保護等級0.6~1.6KV，高放電能量Class I+II/B+C，無洩漏電流，DIN導軌安裝模組化設計，三模塊插洞設計，熱保護脫扣設計，內建滅弧裝置，紅色落牌故障警示，常開長閉故障信控輔助接點。10/350 limp 12.5KA, 8/20  $\mu$ s Imax 100KA, Class I+II/B+C。

Single phase power supply system, AC and DC application 150 to 800V, max. discharge current 100KA class II + I, Inbuilt Arc-extinguishing device, high energy MOV and GTD hybrid unit inside Imax 100KA, Vp up to 1.6KV no leakage current, DIN rail mounting, modular design, red sign fault indication, 10/350 limp 12.5KA, remote aux. relay 1NO 1 NC.



## TVSS 突波保護器箱型 JDA TvssPro-xxx-x

突波保護器箱型：低壓供電系統突波保護器，適用I級&II級保護，符合IEC61643-11:2005 UL 1449 ed.3，MOV與GDT高釋放能量，低電壓保護水平，內建過電流斷路器，老化故障指示及電擊計數器。

Imax 60~480KA，金屬外殼、非金屬外殼可客製，溫度-40°C~+70°C。

Class I+II arrester in according with IEC 61643-1:2005, High energy MOV and GDT, Low voltage protection level. Built in circuit breaker provide over-current protection. Steel enclosure, not exhaust when exposed to lightning strikes. Degradation failure indicates and lightning strikes count. Imax 60~480KA, working temperature -40°C ~ +70°C.



## surgeCon SEC 雷擊計數器 SEC-035

SurgeCon SEC主動式雷擊計數，計數電流 > 0.5KA，爬升時間 $\geq$ 8 $\mu$ s，無需外加電源，脈衝感應，6位數機械計數顯示，操作溫度-20~+60°C，保護等級IP67，接地線貫穿本體免接線介面，適用任何雷擊保護設備。

SurgeCon SEC counting current > 0.5KA, climb  $\geq$ 8 $\mu$ s, 6-digit mechanical counting display, operation temperature from -20 to +60°C, protection IP67, Can be used together with all kinds of lightning protectors and equipment.



**SPD Testing instrument**  
**SPD 測試器 T18**

SPD T8測試器是專為現場測試的突波保護器 (SPD)。可用於測試不同SPD的標稱電壓和漏電流，依據 IEC、IEEE、ANSI標準。  
 SPD T8 Tester is designed for on-site testing of Surge Protective Devices (SPD). It allow to measures both the Nominal Voltage and Leakage Current of different SPDs according to IEC, IEEE, ANSI standards.



**Lightning Even Counter**  
**訊號雷擊計數器 ECL-A-xx**

感應：>100A · LED指示燈 · 霍爾感測 · DIN rail安裝 · 計數0~99 · 電池壽命大於一年 · 電池：工業級電池 · 在線直接充電 · DIN43880, 2module寬36mm · 溫域-40~+80°C · 阻燃UL94-V0。  
 Lightning event counter is used for testing the lightning event in a certain area.

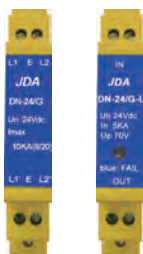

**Data Network Protector for high-frequency signal transmission**  
**訊號突波保護器DN-24IG-XX**

插拔模塊 · DIN rail安裝 · 8/20us電流波In.5KA · 箝制電壓(保護水平) 25V,-95V · 溫域-40~+80°C · 阻燃UL94-V0 · 另有指示燈規格可選。  
 Signal transmission, surge protective devices with plug-in protection modules for high-frequency signal transmission systems against surges at the boundaries from lightning protection zone 0B>2, Signal transmission is not interrupted when exchanging modules, max. discharge current 10KA, 35 mm DIN-rail mounting design.



**Data Network Protector for high-frequency signal transmission**  
**訊號突波保護器DN-24IG-2G**

插拔模塊 · DIN rail安裝 · 8/20us電流波In.10KA · 箝制電壓(保護水平) 25V,-95V · 溫域-40~+80°C · 阻燃UL94-V0。  
 Signal transmission, surge protective devices with plug-in protection modules for high-frequency signal transmission systems against surges at the boundaries from lightning protection zone 0B>2, max. discharge current 20KA, 35 mm DIN-rail mounting design.



**Data Network Protector for analogue telecommunication**  
**訊號突波保護器DN-xxxAT**

插拔模塊 · DIN rail安裝 · 8/20us電流波In.5KA · 箝制電壓(保護水平) Line-Line ≤700V-1000V · 溫域-40~+80°C · 阻燃UL94-V0。  
 Data network protector in according with IEC61643-11 : 21,Two parts design, surge protection modules to be exchanged easily,  
 Signal transmission is not interrupted when exchanging modules,  
 Limit the transients with gas discharge tubes and varistors,  
 Two-stage protection circuit,  
 For universal analogue tele-communication protection,  
 35 mm DIN-rail mounting design.

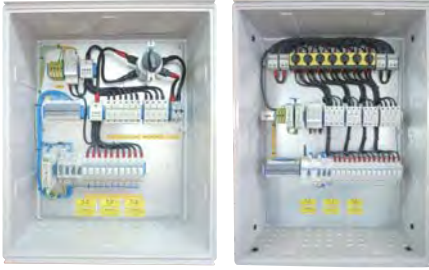

### PV array smart combiner box stringMoni® 智慧型直流匯流箱

IP65/67 · 500, 800, 1000Vdc · 1, 2, 3, 4, 6, 8, 12, 16, 24串列組合 · VDE 0100 and IEC 60364-7-712, IEC 62109-4 · stringMoni IP 65/67, 500-1000Vdc, 1, 1, 2, 3, 4, 6, 8, 12, 16, 24 strings, Monitoring and protect each string, solve problems immediately. All the most significant data are transmitted via RS 485.



### PV array strings box with surgeCon 串列匯流箱附雷擊計數器

二串輸出 · 配置IP67防水箱 · 4P 1000Vdc直流開關1個或2P二個 · 直流保險絲及座4個(正負極各2個) · 突波保護器1個 · 適用二只追蹤器之逆變器 · 1個雷擊計數器 · 4~6KW用或依開關電流額定適用10~25KW ·

Two strings combiner box with surge counter SurgeCon for 2MPPT tracker. Configure with IP67 enclosure, 4 pole 1000Vdc DC disconnects or 2pcs 2 pole 1000Vdc DC disconnect, PV fuse 4pcs, DC surge protector 2 pcs, SurgeCon 1pc, for 4~6KW PV system or for 10~25KW in according with rated current of DC disconnect switch, IEC 62109-4.



### PV array strings box with surgeCon 串列匯流箱附雷擊計數器

三串輸出 · 配置IP67防水箱 · 6P 1000Vdc直流開關 1個或2P三個, 直流保險絲及座 6個(正負極各3個), 突波保護器 3個 ·

適用三只追蹤器之逆變器 · 1個雷擊計數器 · 6~10KW用或依開關電流額定適用10~25KW · Three strings combiner box for 3MPPT tracker. Configured with IP67 enclosure, 6 pole 1000Vdc DC disconnect or 3pcs 2poles 1000Vdc DC disconnect, PV fuse 6pcs, DC surge protector 3 pcs, SurgeCon 1pc, for 6~10KW PV system or for 10~25KW in according with rated current of DC disconnect switch.



### AC Box AC交流開關箱

交流開關箱：多數歐盟國家規定必須裝置交流斷路器、漏電斷路器、突波(過壓)保護器 · 箱體配置歐式端子並予結線 · 現場安裝節省成本與時間 · 除了歐規還有美規以及接受客製 · AC Combiner box with MCCB, AC surge protector.



### Energy meter 單相瓦時表 WHM10-DIN

單相瓦時表 · DIN導軌安裝 · IP40保護 · 免電源 · 32A · 5位數LCD · 一個脈衝輸出 ·

One-phase energy meter with LCD data displaying, indicated for active energy metering. Housing for DIN-rail mounting, IP40 (front) protection degree. Direct connection up to 32A.

## 產品規格Product Characteristics

防水防塵等級 Ingress Protection Water, dust-proof grade IP66/67, Degree of strength IK07/08

材質Material quality : A:ABS , C:PC , P:PC/ABS

耐溫Critical temperature : ABS : -40°C -+85°C ; PC: -40°C-+120°C

耐熱Burn poorly : PC/ABS : 0-5VA ; ABS : 94-V-0

型號Products Type : P series / H series / S,M series / D series

**P series : Hinge type**



**H series : stainless hinge type**



**S/M series : screw type**



**D series : All-in-one-Dual door**



## Accessories



Steel back panel  
(zinc plating)



plastic mounting  
plates (ABS)



Lock catch  
(K40)



Locker  
(SK)



plastic locker  
(PK)



JDA-PSK



JDA-PSK



Vent  
(V60, V80)



Plastic bracket  
(PB20, 25)





內建30家以上協定持續增加  
適合屋頂型、小 / 中 / 大型 太陽能系統專用

內建免費 OPC 伺服軟體、可整合符合 SCADA 的驅動程式、  
提供所有 SCADA 系統整合廠商監測資料訊息平台。

**stringMoni**®

監測每一串狀態

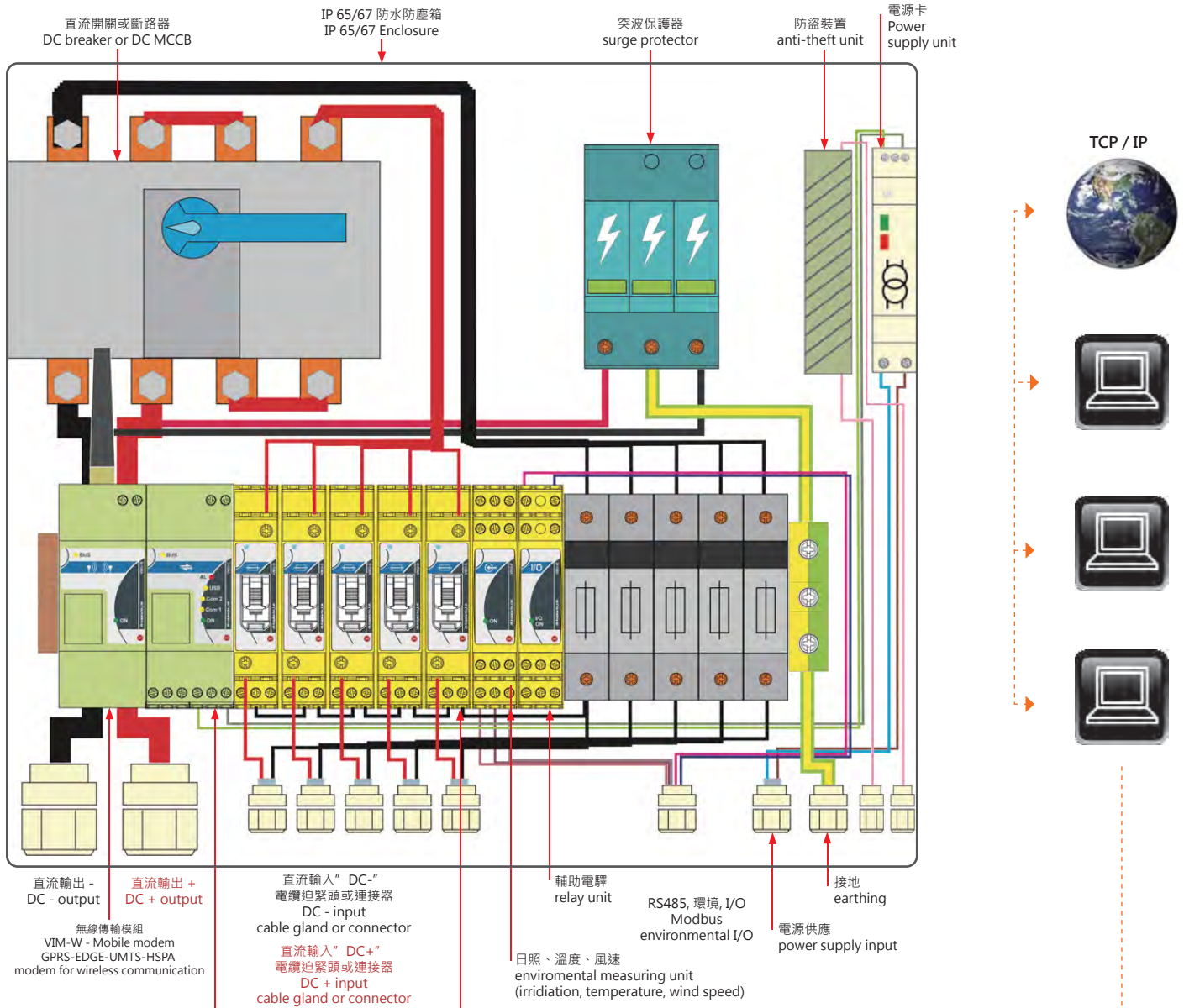

網頁伺服器：網頁、碳油排放量、節油、植樹、顯示電壓電流功率、電度、日照、溫度、風速、突波保護器狀態、開關狀態、發電資料收集紀錄、RS485傳輸、財務回收資料、圖表曲線、系統效率、單串效率、直流輸出串參數及位址。  
WIM-C web-Server (Home page at a glance, kW, kWh, CO<sub>2</sub> tree and oil savings, irradiation, temperature and wind speed, daily financial, total incentives and bill savings, performing versus trend, payback time, string efficiency, DC power), pvBos™ & string address.

串列監測、VA、絲熔斷反極性  
string measuring unit  
(VA, fuse blow out, wrong polarity)

※ 電腦監控畫面 · 即時掌握發電狀況 ※

**產品優勢**

- 易安裝：VIM-S 直接取代直流匯流箱正極保險絲，兼具保護及監測功能，不需更改原有箱體。
- 模組化：透過連接埠擴充模組，不需增加配線。
- 萬筆記錄：可透過 RS485 資料收集，及位址化。
- 量測每一串太陽能發電量，即時發現問題。
- 長期可節省成本、提早回收投資報酬率。







符合國際安規，品質保障

我們的生命財產安全，不容許任何一次的意外發生  
您需要**更安全**的太陽能發電系統

✓ 消防安全開關內置電弧偵測，即早預防火災發生。 ✓ 符合 NEC 690.11, 690.5

直流消防安全開關  
The Emergency Switch  
Motor driven / DC disconnect switch



**FFS Safety Switch**

屋頂型應用示意圖

原設置之直流開關箱加配電動驅動、電弧偵測及緊急按鈕。

火災緊急按鈕  
Fire alarm button



手機連線  
Mobile Phone



直流絕緣接地故障監測  
Earth Fault



**NEW**

直流電弧偵測  
Arc fault detection

緊急按鈕  
Emergency stop push-button  
Operation panel with switch position indication





### 3 Types of Arc-Faults in PV Systems

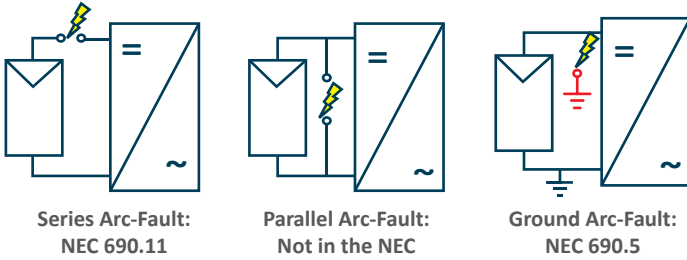

### Application of Arc Detector

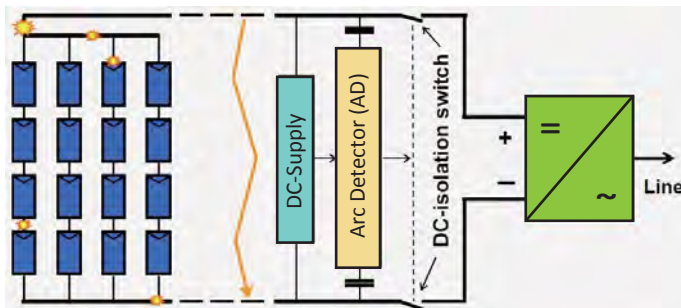

測試標準依據DC專用為UL1699B

<p>TECHNICAL SPECIFICATIONS</p>	<p>200g, DIN Rail TS35, M4 mounting holes , Operational Voltage : 24Vdc, Current consumption : 02A, Operating temperature: -20°C to +70°C , Category : PV AFD-Type 1(UL1699B), Max. Voltage : 1000Vdc, Max. current : 40A, Number of poles : 1 pole Advised cable size : 6mm.</p>
<p>Type code</p>	<p><b>ADU ON DIN RAIL IN IP65 BOX :</b> ADU 1-for 1string , 5 x M16 cable glands ADU 2-for 2strings , 9 x M16 cable glands ADU 3-for 3strings , 13 x M16 cable glands</p> <p><b>SILIOS E : ADU IN IP65 BOX AND X-TYPE DC SW FOR MAX 32A/1000Vdc</b> E1-for 1string and 2poles E14-for 2strings and 4poles E16-for 3strings and 6poles</p>

太陽光電系統之直流電源電路或直流輸出電路，貫穿或在建築物上，而其最大系統運轉電壓為八十伏特以上者，應有經設計者確認之(直流)電弧故障電路斷路器，且屬於太陽光電型式，或經設計者確認為提供同等保護之其他系統組者。太陽光電電弧故障保護裝置應符合下列規定：

- 一、系統應偵測及中斷直流太陽光電電源及輸出電路之導線、連接器、模組或其他系統組件之連續性失效所引發之電弧故障。
- 二、系統應使下列之一失能或切斷：
  - 1、當偵測到故障時，連接至故障電路之變流器或充電控制器。
  - 2、在電弧電路範圍內之系統組件。
- 三、系統應使失能或切斷之設備以手動方式再起動。
- 四、系統應有警示器提供電路斷路器在運轉之燈光警示。此警示信號不得自動復歸。

## DC isolation box with electronic earth fault measurement and motor drive

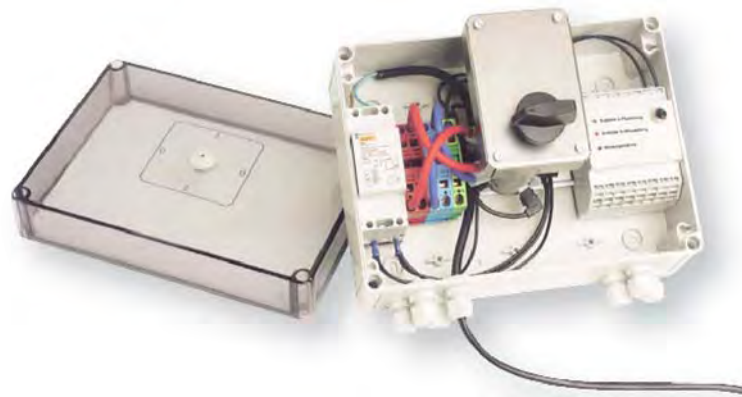

- Separate earth fault measurement in positive and negative wires with LED display Measurement-taking with LED display.
- Motor drive with possible activation from a distance.
- Manually operated.



Motor drive 24V



Electronic earth fault measurement

專用於太陽能直流端發電光伏系統絕緣偵測，真正的直流漏電偵測裝置，防止因系統長久運轉或曝曬絕緣老化發生觸電危險，漏電流偵測裝置會監測直流正極和負極電流之間區別，當電流差異大於設定值，太陽能模組端直流發電將停止輸出。

接地故障保護裝置：所有太陽光電電源及輸出電路應有接地故障保護裝置，或符合下列規定之系統：  
（一）接地故障偵測。（二）接地故障顯示。（三）自動隔離所有導線，或使連接至故障電路之變流器或充電控制器自動停止供電至輸出電路。



**Data Sheet** Santon X-Type switch XA100.16B4E-A

Switch disconnecter for solar application according to IEC 60947-3 by KEMA

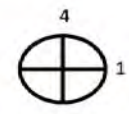

Terminals Scheme							
Layer No.	Front Side		Symbol	Rear Side		On Positions	
	Left	Right		Left	Right	1	2 3 4
5	+2			+2		X	
4		-2			-2	X	
3		-1			-1	X	
2		+1			+1	X	
1			empty				

Contacts are made in "X" marked position.  
Symbols for interconnection: [

Technical data	Symbol	Merit	Unit
nominal voltage (DC poles)	Ue		1000 V dc
nominal current (DC poles)	Ie		16 A dc
nominal voltage (second rating DC poles, if requested)	Ue		850 V dc
nominal current (second rating DC poles, if requested)	Ie		20 A dc
nominal voltage (third rating DC poles, if requested)	Ue		800 V dc
nominal current (third rating DC poles, if requested)	Ie		25 A dc
method of mounting	DIN rail and or Base mounting [B]		
number of DC poles			4
utilization category DC	DC-21B		
actuator	standard black [A]		
positions	OFF at 12 hr, ON at 3 hr [E]		
rated impulse withstand voltage	Uimp		8 kV
insulation voltage	Ui		1000 V
rated thermal current uninterrupted duty	Iu		16 A
rated short-time withstand current (1s)	Icw		750 A
rated short-circuit making capacity	Icm		1,4 kA
rated conditional short-circuit current			5 kA
max power dissipation			1,4 W
method of operation	independent manual operation		
minimum required dimensions of enclosures L x W x H*			124 x 47 x 84,5 mm
* see the drawing for the height of the switch. The number of layers N is:			5
Shaft length			mm
Enclosure depth from inside bottom to outside top, required for the switch and knob			51,5 mm
tightening torque terminal screws M4 , min. - max.	1,5		1,7 Nm
tightening torque M3 screw in the standard black knob, min. - max.	0,5		0,7 Nm
tightening torque for the nut on the single hole mounting knob, min. - max.	1,8		2,0 Nm
minimum required fine wire cross-section: IEC60947-1, table 9			2,5 mm <sup>2</sup>
ambient temperature allowed between			- 20 to + 70 °C °C
storage temperature allowed between			- 40 to + 80 °C °C
maximum relative humidity, without condensation at 20 °C			90 %
pollution degree			2
IP rating terminals			IP20
IP rating gland of the shaft in case of single hole panel mounting			
nominal voltage (AC poles)	Ue		V ac
nominal current (AC poles)	Ie		A ac
number of AC poles			
auxiliary contact(s)			No auxiliary contact
auxiliary contact ratings			
weight			254 g
accessories:	-		
	-		

Superior Switch Solutions

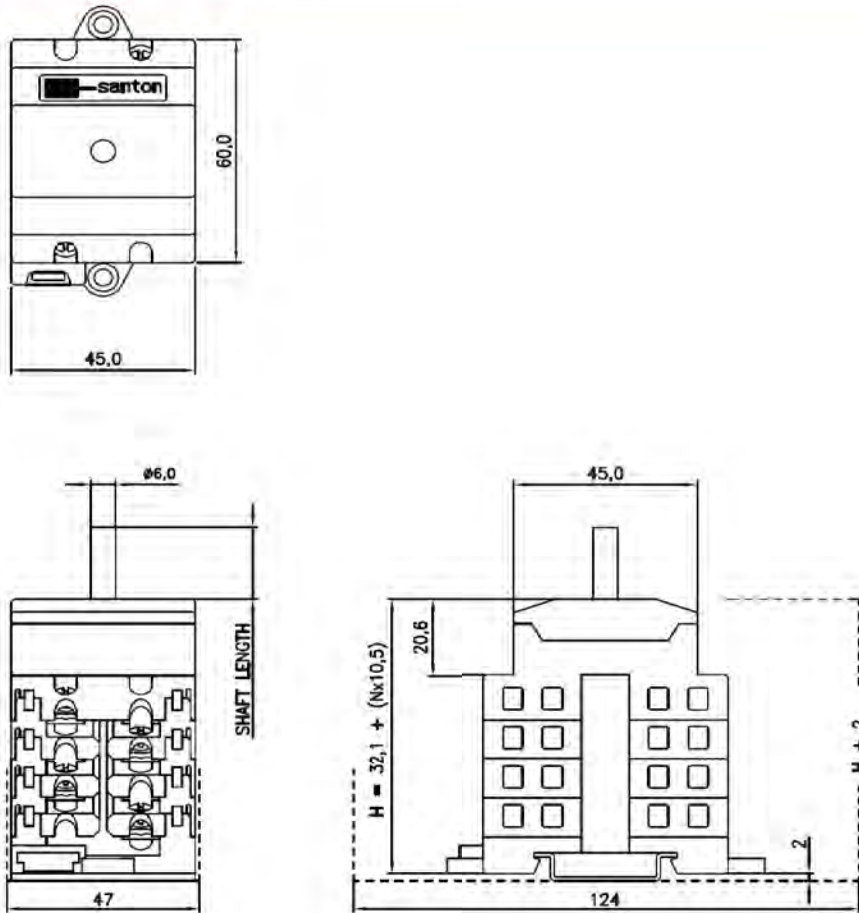

#### Mounting instructions

In the application all ratings have to be respected. When building the switch in an enclosure, the space envelope must be respected according to the applicable standards. The terminals, without interconnection can take copper wires up to 6 mm<sup>2</sup>. The recommended Spade Tongue Terminals may have a maximum width of 9 mm. For CSA and UL applications, registered Spade Tongue Terminals must be used. The registration numbers are UL: E13288 and CSA: LR7189 (for instance type 165015 from Tyco). After mounting, the wiring must be checked and the switch must operate smoothly.

#### Maintenance

The X type switches are designed for a very long life but it is advised to do some simple yearly maintenance.

- Check the installation for signs of overload or overheating. The terminals may not exceed the limit of 85°C under full load.
- By operating the switch a few times (5x) the contacts will clean themselves and the switch will have a longer life.

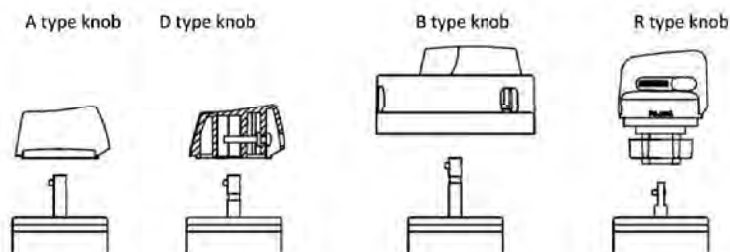

Dimensions, specifications and data shown could be subject to change without notice.

Superior Switch Solutions



**STANDARD COMBINATIONS ACCORDING TO IEC60947-1/3-DC21**

Nominal voltage (V)						
1500	*	*	*	*	*	*
1200	*	*	*	*	*	*
1000	100.16	100.25	100.32	multipole (see page 5)	*	*
850	85.16	75.25				
750						
600	60.16	60.25	60.32	multipole (see page 5)	multipole (see page 5)	multipole (see page 5)
	0	16	25	32	2x32	3x32
Nominal current (A)						
	* on request					

**STANDARD COMBINATIONS ACCORDING TO UL508**

Nominal voltage (V)						
600	60.16..K	60.25..K	60.32..K	multipole (see page 5)	multipole (see page 5)	
400						
200						
	0	16	25	32	2x32	3x32
Nominal current (A)						

**Notes:**

1. Voltages above 1000 Volt are available on request.
2. For multipole switches see page 5.
3. Combined AC/DC switches are available on request.



IEC60947 RATED SWITCHES

Voltage (V) DC21 IEC 60947 1*	Current (A)	Poles 2*	H 3*	Product type code			
				Bottom mounting B	Single hole mounting		
					Panel mounting P	Reversed contacts R	Double mounting D
600	16	2	2	X60.16B2	X60.16P2	X60.16R2	X60.16D2
600	16	4	4	X60.16B4	X60.16P4	X60.16R4	X60.16D4
600	16	6	6	X60.16B6	X60.16P6	X60.16R6	X60.16D6
600	16	8	8	X60.16B8	X60.16P8	X60.16R8	X60.16D8
850	16	2	2	X85.16B2	X85.16P2	X85.16R2	X85.16D2
850	16	4	4	X85.16B4	X85.16P4	X85.16R4	X85.16D4
850	16	6	6	X85.16B6	X85.16P6	X85.16R6	X85.16D6
850	16	8	8	X85.16B8	X85.16P8	X85.16R8	X85.16D8
1000	16	2	3	X100.16B2	X100.16P2	X100.16R2	X100.16D2
1000	16	4	6	X100.16B4	X100.16P4	X100.16R4	X100.16D4
1000	16	6	9	X100.16B6	X100.16P6	X100.16R6	X100.16D6
600	25	2	2	X60.25B2	X60.25P2	X60.25R2	X60.25D2
600	25	4	4	X60.25B4	X60.25P4	X60.25R4	X60.25D4
600	25	6	6	X60.25B6	X60.25P6	X60.25R6	X60.25D6
600	25	8	8	X60.25B8	X60.25P8	X60.25R8	X60.25D8
750	25	2	2	X75.25B2	X75.25P2	X75.25R2	X75.25D2
750	25	4	4	X75.25B4	X75.25P4	X75.25R4	X75.25D4
750	25	6	6	X75.25B6	X75.25P6	X75.25R6	X75.25D6
750	25	8	8	X75.25B8	X75.25P8	X75.25R8	X75.25D8
1000	25	2	3	X100.25B2	X100.25P2	X100.25R2	X100.25D2
1000	25	4	6	X100.25B4	X100.25P4	X100.25R4	X100.25D4
1000	25	6	9	X100.25B6	X100.25P6	X100.25R6	X100.25D6
600	32	2	2	X60.32B2	X60.32P2	X60.32R2	X60.32D2
600	32	4	4	X60.32B4	X60.32P4	X60.32R4	X60.32D4
600	32	6	6	X60.32B6	X60.32P6	X60.32R6	X60.32D6
1000	32	2	3	X100.32B2	X100.32P2	X100.32R2	X100.32D2
1000	32	4	6	X100.32B4	X100.32P4	X100.32R4	X100.32D4

UL508 RATED SWITCHES (cCSAus)

Voltage (V) UL508	Current (A)	H 3*	Poles Double pole switching	Bottom mounting	Panel mounting	Poles Single pole switching	Bottom mounting	Panel mounting
				4*	4*		4*	4*
				B	P		B	P
600	16	2	2	X60.16BK2	X60.16PK2	1	X60.16BKS1	X60.16PKS1
600	16	4	4	X60.16BK4	X60.16PK4	2	X60.16BKS2	X60.16PKS2
600	16	6	6	X60.16BK6	X60.16PK6	3	X60.16BKS3	X60.16PKS3
600	16	8	8	X60.16BK8	X60.16PK8	4	X60.16BKS4	X60.16PKS4
600	25	2	2	X60.25BK2	X60.25PK2	1	X60.25BKS1	X60.25PKS1
600	25	4	4	X60.25BK4	X60.25PK4	2	X60.25BKS2	X60.25PKS2
600	25	6	6	X60.25BK6	X60.25PK6	3	X60.25BKS3	X60.25PKS3
600	25	8	8	X60.25BK8	X60.25PK8	4	X60.25BKS4	X60.25PKS4
600	32	2	2	X60.32BK2	X60.32PK2	1	X60.32BKS1	X60.32PKS1
600	32	4	4	X60.32BK4	X60.32PK4	2	X60.32BKS2	X60.32PKS2
600	32	6	6	X60.32BK6	X60.32PK6	3	X60.32BKS3	X60.32PKS3
600	32	8	8	X60.32BK8	X60.32PK8	4	X60.32BKS4	X60.32PKS4

\*1 Switches with combined DC and AC poles are also available.

\*2 The number of main poles without auxiliary contacts.

\*3 With the total number of layers "H", the total height of the switch can be determined. For mounting type B and D "H" has to be increased with one. See drawings on page 6.

\*4 Fixing method "R" and "D" (see page 6) are also certified.

**Auxiliary contacts**

For position indication or for motor driven switches auxiliary contacts are available. The auxiliary contacts are rated 16A at 250V AC and DC. Add one extra layer for every auxiliary contact to determine the height of the switch.



# P-type Disconnect

According to the UL508 standard



600 VDC disconnect switches					
Amperes	1 Poles*1	2 Poles	3 Poles	4 Poles	6 Poles
16A	•	•	•	•	•
36A	•	•	•	•	•
63A	•	•	•	•	•
120A	•	•	•	•	•
180A	•	•	•	•	•
200A	• *2	•	•	•	•
250A	•	•	•	•	•
350A	•	•	•	•	•
500A	•	•	•		
800A	•	•			



These combinations are UL508 certified

- \*1. two poles in series generate a one pole switch for switching off one electrical circuit of the nominal current at 600VDC
- \*2. the 200A is only certified with two independent poles for one electrical circuit
- \*3. combination switches AC/DC on request
- \*4. auxiliary contacts are available



# P-type Disconnect

According to the IEC standard

Switches 1000V DC21 (IEC60947-1/3)					
Amperes	2 Poles*1	4 Poles	6 Poles	8 Poles	12 Poles
16A	•	•	•	•	•
25A	•	•	•	•	•
40A	•	•	•	•	•
63A	•	•	•	•	•
100A	•	•	•	•	•
200A	•	•	•	•	•
300A	•	•	•	•	
500A	•	•	•		
800A	•	•			
1000A	•				

Switches 600V DC21 (IEC60947-1/3)					
Amperes	2 Poles*1	4 Poles	6 Poles	8 Poles	12 Poles
16A	•	•	•	•	•
25A	•	•	•	•	•
40A	•	•	•	•	•
63A	•	•	•	•	•
100A	•	•	•	•	•
200A	•	•	•	•	•
300A	•	•	•	•	•
500A	•	•	•		
800A	•	•			
1000A	•				

- See “Switches Catalogue” for type coding for position selection options
- Together with indication plates and bottom and / or top mounting versions.
- Customized shaft lengths.
- See “Accessories Switches” for all available accessories.



- MCCB is suitable for DC application such as Photovoltaic Circuit Breaker, UPS and datacenter
- DC short circuit test tested by VDE
- Higher nominal voltage range up to 1000 VDC
- Rated Current : 16A~800A
- No of Pole : 2/3/4Pole
- Available for AC/DC application

Frame size		(AF)
Rated current, I <sub>n</sub>		(A)
No. of Poles		(Pole)
Rating (DC)	1000V	
	750V	
	500V	
Rated service breaking (DC)	Type	
	1000V (4P)	
	750V (3P)	
	500V (2P)	
Trip unit		
	FTU ((fixed-thermal, fixed-magnetic)	
	FMU (adjustable-thermal, fixed-magnetic)	
	ATU (adjustable-thermal, adjustable-magnetic)	

TD100			TD160			TS100		
100			160			100		
16, 20, 25, 32, 40, 50, 63, 80, 100			100, 125, 160			40, 50, 63, 80, 100		
2, 3, 4			2, 3, 4			2, 3, 4		
4P			4P			4P		
3P			3P			3P		
2P			2P			2P		
N	H	L	N	H	L	N	H	L
42	65	100	42	65	100	50	85	100
42	65	100	42	65	100	50	85	100
42	65	100	42	65	100	50	85	100
●	●	●	●	●	●	●	●	●
●	●	●	●	●	●	●	●	●
-	-	-	-	-	-	-	-	-

Exemplary circuit diagrams

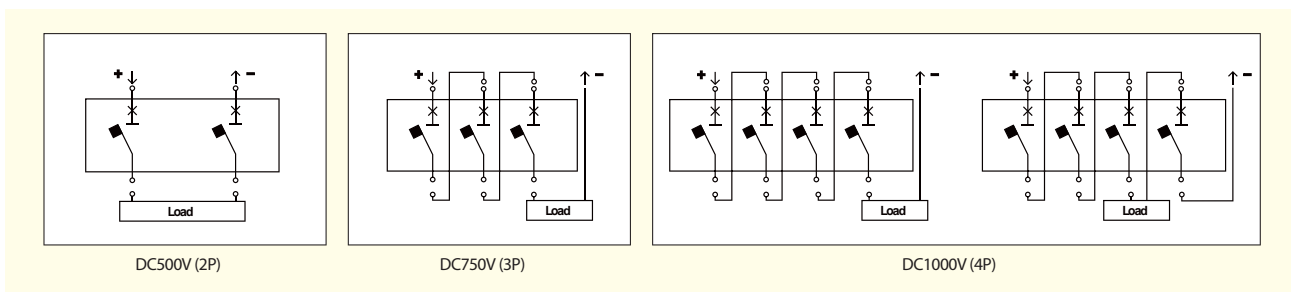





TS160			TS250			TS400			TS630			TS800		
160			250			400			630			800		
100, 125, 160			125, 160, 200, 250			300, 400			500, 630			700, 800		
2, 3, 4			2, 3, 4			2, 3, 4			2, 3, 4			2, 3, 4		
4P			4P			4P			4P			4P		
3P			3P			3P			3P			3P		
2P			2P			2P			2P			2P		
N	H	L	N	H	L	N	H	L	N	H	L	N	H	L
50	85	100	50	85	100	50	85	100	50	85	100	50	85	100
50	85	100	50	85	100	50	85	100	50	85	100	50	85	100
50	85	100	50	85	100	50	85	100	50	85	100	50	85	100
●	●	●	●	●	●	●	●	●	●	●	●	●	●	●
●	●	●	●	●	●	●	●	●	●	●	●	●	●	●
●	●	●	●	●	●	●	●	●	●	●	●	●	●	●



## MppGuard product details

- MPP-Tracking on string level
- high efficiency (> 99 %)
- weatherproof housing, protection class IP 65
- one MPP-Tracking in one housing\*
- Connection of strings up to max. 12,5A (Impp)



## Technical data MppGuard

max. input voltage in idle state :	780 Voc DC
Arbeitsbereich MPP-Spannung :	250 V – 680 V DC
max. input current / string :	12,5A DC
Input power :	7,5 kWp
max. output voltage (Intermediate circuit) :	800 V DC
min. output voltage (Intermediate circuit) :	590 V DC (20 V DC over input voltage)
junction modules :	(MC4 or comparable)
junction DC-output :	(MC4 or comparable)
junction communication / monitoring :	RS-485
cooling :	passive (free convection)
performance monitoring :	web portal Sinusstrom Control
task of the MPP-Tracking :	determination of the optimal operating point of the modules allows a yield optimization of the whole system.
Dimension :	240 * 340 * 160 mm
Weight :	approx. 7 Kg









日揚科技有限公司  
JD Auspice Co., Ltd

