

ENERIUM[®]

P O W E R M O N I T O R S



- Communication and programming via optical interface, or remotely via **Ethernet network** or RS485 output
- **Energy**: measurement on all 4 quadrants in class 0.5s according to IEC 62053-22
- Up to **8 load curves**
- Up to **4 trend curves**
- **Display of harmonics** by order
- **8 inputs / outputs** as required
- Up to **8 configurable alarms**
- **Log of last 64 events**
- Possibility of upgrading the embedded software via the **optical interface**
- **Graphic display** (Enerium 150 only): Fresnel diagram, harmonics in bargraph form, U, I and P displayed as gauges
- Version without display for mounting in cabinet

**ETHERNET
COMMUNICATION**

The Range

◆ The ENERIUM range comprises six power monitors, including two without a display.



Enerium 50
96 x 96 format

Harmonics up to 25th order
2 inputs or 2 outputs
8 load curves

742



Enerium 100/110
144 x 144 format

Harmonics up to 25th order
4 inputs/4 outputs
4 trend curves
Neutral current measurement

572

- Measurement of the 1s, min., max. and avg. values of the electrical quantities
- Energy metering in all 4 quadrants
- Measurement of harmonics by order up to the 25th order
- Measurement of THD-U, THD-V and THD-I, crest factor and composite voltage unbalance
- Measurement of $\cos \varphi$ and power factor
- Up to 8 configurable alarms each with 2 conditions (and, or)
- Recording of the last 64 overruns with time/date-stamping
- Energy management by recording 1 to 8 load curves chosen among 10 measured or calculated quantities: P+, P-, Q1, Q2, Q3, Q4, S+, S-, On-off1 and On-off2 (integration time 10 minutes to 60 minutes)
- 2 configurable inputs (metering, on-off)
- 2 configurable outputs (alarm, pulse or analogue: ± 20 mA)
- Communication
 - via optical interface
 - via RS485 link with ModBus protocol
 - via Ethernet with ModBus/TCP protocol
- 1 external synchronization input
- Software updating and upgrading via the optical interface (option)
- Large backlit 10 x 128-pixel graphic screen
- Measurement on 400 Hz networks

- Measurement of the 1s, min., max. and avg. values of the electrical quantities
- Energy metering in all 4 quadrants
- Measurement of harmonics by order up to the 25th order
- Measurement of THD-U, THD-V and THD-I, crest factor and composite voltage unbalance
- Measurement of $\cos \varphi$ and power factor
- Up to 8 configurable alarms, each with 2 conditions (and, or)
- Recording of the last 64 overruns with time/date-stamping
- Memorization of trend curves (up to 4) with a recording interval of 1 second to 60 minutes
- 4 configurable inputs (metering, on-off)
- 4 configurable outputs (alarm, pulse or analogue: ± 20 mA)
- Communication :
 - via optical interface
 - via RS485 link with ModBus protocol
 - via Ethernet with ModBus/TCP protocol
- Software updating and upgrading via the optical interface (option)
- Wide 80 x 97 mm backlit screen
- Measurement on 400 Hz networks



Enerium 150
96 x 96 format

Harmonics up to 50th order
2 inputs or 2 outputs
8 load curves
4 trend curves
Graphs (Fresnel, bargraph, etc.)

772



Enerium 200/210
144 x 144 format

Harmonics up to 50th order
4 inputs/4 outputs
8 load curves
Measurement indicator LED

772

- Same basic characteristics as the ENERIUM 50
- Measurement of harmonics up to 50th order
- Memorization of trend curves (up to 4) with a recording interval of 1 second to 60 minutes.
- Graphs
 - Fresnel diagram (network unbalance)
 - Bargraph of harmonics
 - U, I and P displayed as gauges

- Same basic characteristics as the ENERIUM 100/110
- Measurement of harmonics by order up to 50th order
- Energy management: by recording the load curves of 1 to 8 quantities chosen among 12 (P+, P-, Q1, Q2, Q3, Q4, S+, S-, On-off1, On-off2, On-off3, On-off4) with an adjustable integration period (34 days' recording with an integration period of 10 minutes, for example).



A version without a display (ENERIUM 110 and 210) for mounting on DIN rail or on a plate in a cabinet



An optical interface with 3 functions:
- Programming
- Verification
- Upgrading

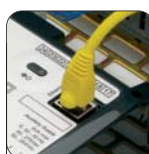

An Ethernet output using the ModBus TCP protocol, an RS485 or ModBus/JBus protocol



Up to 8 configurable inputs (pulse, On-off, external synchronization) or outputs (pulse, analogue, On-off, alarms)



Measurement of earth-neutral voltage (with Enerium 100 and Enerium 200)

and its applications

- ◆ Whatever field you are working in, whether processing industries, infrastructures or tertiary production, you are affected by **energy efficiency** issues.

EXAMPLES OF APPLICATIONS

ENERGY MANAGEMENT

- **Measure all types of energy consumption** and check billing
- Control costs and **optimize consumption** according to applicable rate contracts
- **Allocate the costs** per work centre
- **Monitor active power consumption** trends
- **Class 0.5s** (IEC 62053-22)
- Up to **8 configurable inputs/outputs** for multi-energy measurement



MONITORING

- **Monitor** the functional parameters in real time and remotely
- **Record all the essential electrical parameters** of an installation
- **Measure and analyse drift** to avoid operating losses
- **Manage alarms remotely**, analyse the event log and verify circuit-breaker status
- Measure U and I with **±0.2% accuracy**

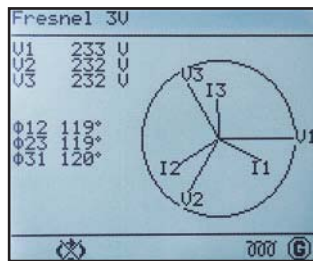

SIZING

- Assess the possibility of **adding loads to a network** or modifying a production process
- Define **reactive energy compensation requirements**: reduced penalties, increase in available active energy depending on long process variations
- Find out the transformer's load rate
- Simultaneously **record 4 trend curves** chosen among 12 quantities measured or calculated by the product

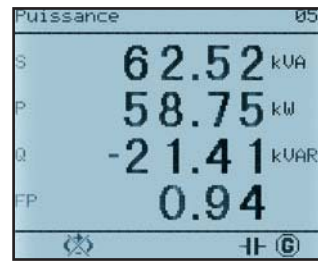

QUALITY

- **Investigate** the possible causes of **dysfunction** linked to harmonics
- **Evaluate** the way electrical equipment **ages**
- Assess distorting power due to harmonics
- **Measure the harmonics** per order and per phase:
 - phase-to-earth and phase-to-phase voltage
 - current up to **order 50** (25 for Enerium 100/110)



SCREENS

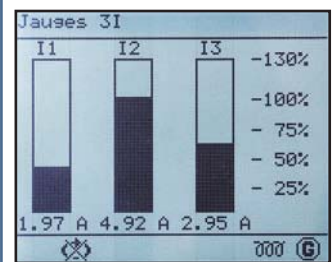
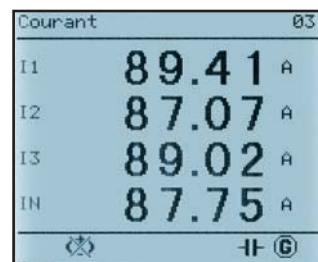
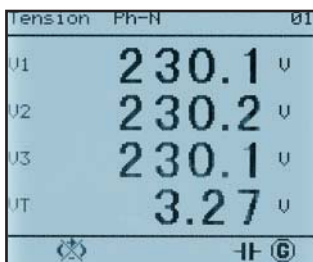

MAIN FEATURES

- **Load curves** for each type of energy measured
- Automatic reconstitution of **total consumption index**

- Measure energy in **all 4 quadrants in class 0.5s**
- **Measure the earth-neutral voltage**
- **Display and record** instant, minimum, maximum, average minimum and average maximum values
- **8 alarms** with “and” or “or” conditions
- **Log of last 64 events**
- **Verify correct wiring order**
- **Monitor electrical network balance**
- Monitor alarm status locally (flashing on screen)

- Measure and record the **cos φ and power factor** per phase (average and instantaneous in all 4 quadrants)

- Measure **THD-U, THD-V** and **THD-I**
- Measure the **unbalance**

Specifications

Special features

	ENERIUM 50	ENERIUM 100	ENERIUM 110	ENERIUM 150	ENERIUM 200	ENERIUM 210
Measurements						
Format	96 x 96 mm	144 x 144 mm	144 x 144 mm	96 x 96 mm	144 x 144 mm	144 x 144 mm
Graphic LCD screen	x	x	without display	x	x	without display
Neutral current	calculated	measured	measured	calculated	measured	measured
Harmonics	25th order	25th order	25th order	50th order	50th order	50th order
tan φ	x	-	-	x	-	-
Inputs (option)						
Number	2	4		2		4
Type	alarm, pulse, analogue					
Outputs (option)						
Nombre	2	4		2		4
Type	alarme, impulsion, analogique					
Input/output cards						
Option cards	1	4		1		4
Curves						
Load curves	8	-	-		8	
Trend curves	-	4			4	
Communication interface						
Optical	front	front and rear		front	front and rear	
Ethernet or RS 485	x	x	x	x	x	x
Measurement indicator LED	-	x	x	-	x	x
Graphics						
Fresnel	-	-	-	x	-	-
Gauges	-	-	-	x	-	-
Bargraph	-	-	-	x	-	-

General specifications

	1 S	MIN	MAX	AVG	AVG MIN	AVG MAX
V1, V2, V3, Vearth	•	•	•	•		•
U12, U23, U31	•	•	•	•		•
I1, I2, I3, In	•	•	•	•		•
P1, P2, P3	•		• ⁽¹⁾	• ⁽¹⁾		
Pt	•	• ⁽¹⁾	• ⁽¹⁾	• ⁽¹⁾		• ⁽¹⁾
Q1, Q2, Q3	•		• ⁽¹⁾	• ⁽¹⁾		
Qt	•	• ⁽¹⁾	• ⁽¹⁾	• ⁽¹⁾		• ⁽¹⁾
S1, S2, S3	•		•	•		
St	•		•	•		•
FP1, FP2, FP3	•			• ⁽¹⁾		
FPt	•			• ⁽¹⁾	• ⁽¹⁾	• ⁽¹⁾
Cos φ 1, Cos φ 2, Cos φ 3	•			• ⁽¹⁾		
Cos φ t	•			• ⁽¹⁾	• ⁽¹⁾	• ⁽¹⁾
tan φ	•					
Frequency	•	•	•	•		
Crest factor V1, V2, V3	•			•		•
Crest factor I1, I2, I3	•			•		•
U unbalance	•			•		•
Harmonics ⁽²⁾ 0 to 50 V1,V2, V3, U12, U23, U31, I1, I2, I3	•					•
THD V1, V2, U12, U23, U31, I1, I3	•			•		•
3 hour meters: network presence, under load, auxiliary source	•					
Active energy - receiver, generator	•					
Reactive energy Qcad1, Qcad2, Qcad3, Qcad4	•					
Reactive energy - receiver, generator	•					
Metering pulse input A1, A2, B1, B2, C1, C2, D1, D2	•					

(1) Measurement also possible in generator and receiver modes (2) Up to 25th order with ENERIUM 50/100/110

Voltage inputs	
Measurement range	10 to 120 % of V_n when $V_n = 230$ V (ph-N) 10 to 120 % of U_n when $U_n = 400$ V (ph-ph)
Frequency	50/60Hz or 400Hz
Max. composite voltage measured	650 kV
Admissible overvoltage	800 V during 24 hours 552 V permanent
Consumption	< 0.1 VA
Input impedance	2 M Ω (500 k Ω on ENERIUM 50/150)
Current inputs	
Measurement range	5 to 130 % of I_n when $I_n = 5$ A
CT secondary (I_n)	1 to 5 A
Max. current measured	25,000 A
Admissible overload	6.5 A permanent 250 A for 1 second, 5 times every 5 minutes
Consumption	< 0.15 VA
Digital inputs (on-off or metering pulse)	
Operating voltage	24 to 60 Vdc \pm 20 %
Minimum signal width	30 ms
Consumption	< 0.5 W
Auxiliary power supply	
Power supply	80 to 276 Vac / 80 to 264 Vdc (< 15 VA) 19.2 to 57 Vdc *
Multiple measurements (accuracy)	
Current I	\pm 0.2 % from 5 to 130 % of I_n
Voltage U or V	\pm 0.2 % from 10 to 120 % of U_n/V_n
Active power P	\pm 0.5 %
Reactive power Q	\pm 1 %
Apparent power S	\pm 0.5 %
Frequency F	正確為+/-10mHz詳原廠證書 \pm 0.1 Hz from 42.5 to 69 Hz
Power factor FP and cos φ	\pm 0.02 counts when 0.5 inductive < FP > 0.5 capacitive \pm 0.05 counts when 0.2 inductive < FP > 0.2 capacitive
Sampling rate	6.4 KHz to 50 Hz - measurement without sample loss (0 blind)
Metering (accuracy)	
Active energy	Class 0.5s according to IEC 62053-22
Reactive energy	Class 2 according to 62053-23
Apparent energy	\pm 0.5 %
Qualimetry (accuracy)	
THD-I, THD-U and THD-V	\pm 0.5 counts
Order by order, U, V, I	\pm 0.5 counts
Pulse outputs or alarm relays	
Type	static relay
Operating voltage	24 to 110 Vdc \pm 20 % 24 to 115 Vac - 10 % + 15 %
Max. current	100 mA
Compliant with standard	CEI 62053-31
Analogue output	
Scale	configurable between - 20 mA and + 20 mA
Admissible load	500 W, 10 V/I output
Response time	< 500 ms
RS 485 output	
Connection	2 wires, half-duplex
Protocol	ModBus/Jbus mode RTU
Speed (configurable)	2,400, 4,800, 9,600, 19,200, 38,400 (115 200 ENERIUM 50/150)
Parity	even, odd or none
Jbus addresses	1 to 247
Ethernet output	
Type	RJ45 8-pin connector
Protocol	Modbus/TCP
Speed (configurable)	Compatible with 10baseT

* available as an option

Environmental specifications

Climatic specifications	
Operating temperature	-10°C to +55°C
Humidity during operation	95% at 40°C
Storage temperature	-25°C to +70°C
Safety specifications	
Pollution degree	2
Fire resistance	UL94, severity V1
Installation category	3
Mechanical characteristics	
Ingress protection	front panel IP51 - rear IP20
Mechanical shocks	IEC 61010-1
Vibrations	IEC 60068-2-6 (method A)
Free fall with packaging	NF H 0042-1
Electromagnetic compatibility	
Generic standard	IEC 61326-1

Mechanical specifications

Weight	850g (ENERIUM 100/200)
	700g (ENERIUM 110/210)
	600g (ENERIUM 50/150)
Mounting	DIN 43700 (ENERIUM 50/100/150/200)
Format	DIN 96x96 (ENERIUM 50/150) & DIN 144x144 (ENERIUM 100/110/200/210)
Connection	Screw-lock terminal strip for 6mm ² rigid or flexible wires on current measurement inputs and 2.5mm ² for the other accesses

Trend curves

1S VALUES	
I1, I2, I3, In	•
Pt	•
Qt	•
St	•
FPt	•
U unbalance	•
THD V1, V2, V3	•
THD U12, U23, U31	•
THD I1, I2, I3	•
AVERAGE VALUES	
V1, V2, V3	•
I1, I2, I3, In	•
P1 Gen, P1 Rec, P2 Gen, P2 Rec, P3 Gen, P3 Rec	•
Pt Gen, Pt Rec	•
FP1 Gen, FP1 Rec, FP2 Gen, FP2 Rec, FP3 Gen, FP3 Rec	•
FPt Gen, FPt Rec	•
Cosp1 Rec, Cosp1 Gen, Cosp2 Rec, Cosp2 Gen, Cosp3 Rec, Cosp3 Gen	•
Cosp Gen, Cosp Rec	•
Frequency	•
Crest factor V1, V2, V3	•
Crest factor I1, I2, I3	•
THD U12, U23, U31	•
THD I1, I2, I3	•
THD I1, I2, I3	•
THD V1, V2, V3	•

Load curves

AVERAGE VALUES	
Pt Gen, Pt Rec	•
Qcad1, Qcad2, Qcad3, Qcad4	•
St Gen, St Rec	•
Inputs On-off1, On-off2, On-off3, On-off4	•

Connection configurations

ENERIUM 50/150

Unbalanced 3-phase, 3 wires + 3 CTs

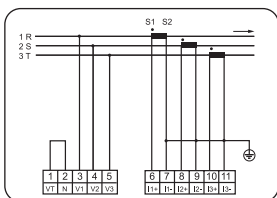

Unbalanced 3-phase, 3 wires + 2 CTs

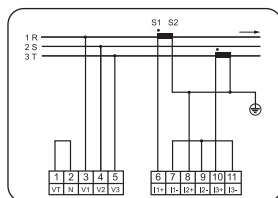

Unbalanced 3-phase, 4 wires + 3 CTs

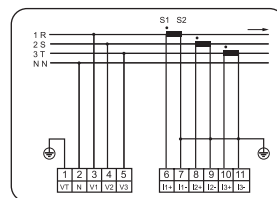

Single-phase connection

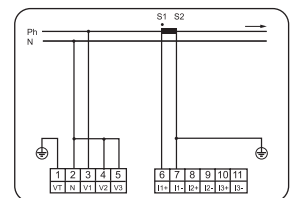

ENERIUM 100/110 - ENERIUM 200/210

Unbalanced 3-phase, 4 wires + 4 CTs

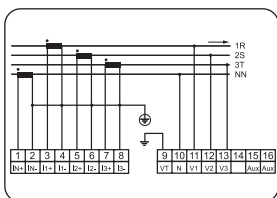

Single-phase connection, 2 wires + 1 CT

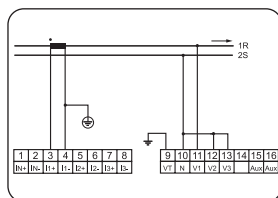

Unbalanced 3-phase, 3 wires + 3 CTs

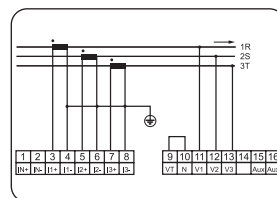

Unbalanced 3-phase, 4 wires + 3 CTs

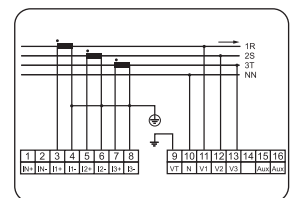

Other configurations are possible: please contact us

Alarms

1S VALUES	
V1, V2, V3, Vearth	•
U12, U23, U31	•
I1, I2, I3, In	•
Pt	•
Qt	•
St	•
FPt	•
Cosp	•
Frequency	•
U unbalance	•
3 hour meters : network presence, under load, auxiliary source	•
AVERAGE VALUES	
Pt Gen, Pt Rec	•
Qt Gen, Qt Rec	•
St	•

Analogues outputs (option)

1S VALUES	
V1, V2, V3, Vearth	•
U12, U23, U31	•
I1, I2, I3, In	•
P1, P2, P3	•
Pt	•
Q1, Q2, Q3	•
Qt	•
S1, S2, S3	•
St	•
FP1, FP2, FP3	•
FPt	•
Cosp1, Cosp2, Cosp3	•
Cosp	•
Frequency	•

To order

Dimensions

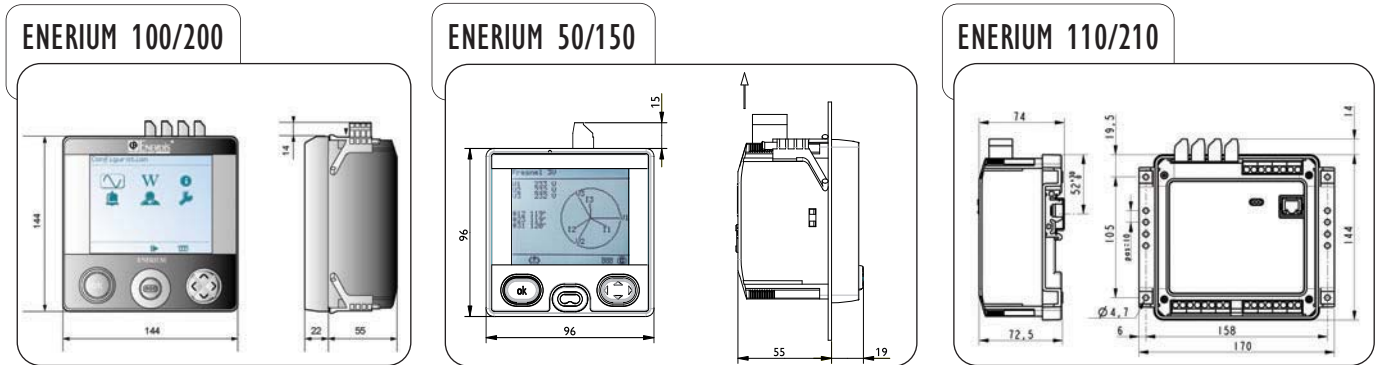

Standard product

Model	Frequency	Power supply	Communication	Metering input	On-off outputs	Analogue outputs	Reference
ENERUM 100	50/60 HZ	80 to 265 Vac / 80 to 264 Vdc	RS485	0	0	0	P01330801
ENERUM 100	50/60 HZ	80 to 265 Vac / 80 to 264 Vdc	RS485	2	2	0	P01330802
ENERUM 200	50/60 HZ	80 to 265 Vac / 80 to 264 Vdc	Ethernet	4	2	0	P01330803
ENERUM 200	50/60 HZ	80 to 265 Vac / 80 to 264 Vdc	RS485	2	2	2	P01330804
ENERUM 50	50/60 HZ	80 to 265 Vac / 80 to 264 Vdc	RS485	0	0	0	P01330805
ENERUM 50	50/60 HZ	80 to 265 Vac / 80 to 264 Vdc	Ethernet	0	0	0	P01330806
ENERUM 50	50/60 HZ	80 to 265 Vac / 80 to 264 Vdc	RS485	1	1	0	P01330807
ENERUM 50	50/60 HZ	80 to 265 Vac / 80 to 264 Vdc	Ethernet	1	1	0	P01330808
ENERUM 150	50/60 HZ	80 to 265 Vac / 80 to 264 Vdc	RS485	0	0	0	P01330809
ENERUM 150	50/60 HZ	80 to 265 Vac / 80 to 264 Vdc	Ethernet	0	0	0	P01330810
ENERUM 150	50/60 HZ	80 to 265 Vac / 80 to 264 Vdc	RS485	0	2	0	P01330811
ENERUM 150	50/60 HZ	80 to 265 Vac / 80 to 264 Vdc	Ethernet	0	2	0	P01330812

Configured product

ENERUM 1 2 3 4 5 6 7

- Model**
 - 50 metering - with display
 - 100 metering - network monitoring + installation sizing - with display
 - 110 metering - network monitoring + installation sizing - without display
 - 150 metering - supervision - with display
 - 200 metering - network monitoring + multi-energy management - with display
 - 210 metering - network monitoring + multi-energy management - without display
- Frequency of network measured :**
 - 0 50/60Hz
 - 1 400Hz
- Power supply**
 - 0 de 80 à 265 Vac / de 80 à 264 Vdc
 - 1 de 19.2 à 58 Vdc
- Communication**
 - 0 RS485
 - 1 Ethernet
- Metering (or on-off) inputs**
 - 0 none
 - 1 1 input (ENERUM 50/150 only)
 - 2 2 inputs
 - 4 4 inputs (not available for ENERUM 50/150)
- 6 On-off outputs**
 - 0 none
 - 1 1 output (ENERUM 50/150 only)
 - 2 2 outputs
 - 4 4 outputs (not available for ENERUM 50/150)
- 7 Analogue outputs**
 - 0 none
 - 2 2 outputs

ACCESSORIES:

Optical interface for ENERUM 50/150	P01330403
Optical interface for ENERUM 100/110 - 200/210	P01330401
E.Set software	P01330501
E.View software	P01330601
E.View+ software	P01330610

Code

Attention, for choices 5, 6 and 7, the maximum possible number of inputs and/or outputs is 8 (ENERUM 100-110/200-210).

Attention, for Enerium 50/150, choices 5 and 6 only allow the following combinations: 0-0, 1-1, 2-0, 0-2.

Example: Enerium 200, frequency 50/60 Hz, auxiliary power supply 24 Vdc, RS485 communication, no outputs and 2 On-off inputs => order ENERUM 200 010200

• 1-200 • 2-0 • 3-1 • 4-0 • 5-2 • 6-0 • 7-0

- ◆ ENERIUM is also a global solution with its associated **software**: configuration, installation diagnosis and display.

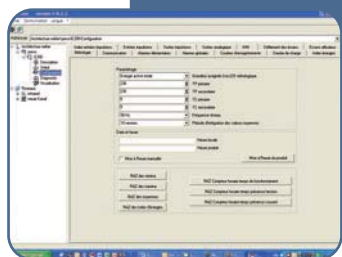

E.set

- **Configure** the power monitors in the ENERIUM range **remotely** via the RS485 network, the Ethernet network or the local area network using the optical interface
- **Program** the products' communication parameters (address, speed, parity, etc.) and the configuration parameters (CT ratio, PT, alarm thresholds, etc.)

E.view

- **Control** the inputs and outputs of the power monitors in the ENERIUM range remotely
- **Display** the basic electrical parameters
- **Retrieve** the recordings of the load curves and trend curves, as well as the alarm log (format .cs, .xls, .txt).

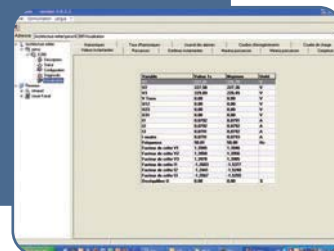

E.view +

- **The same functions as the E.view software with additional tables, bargraphs and curves.**

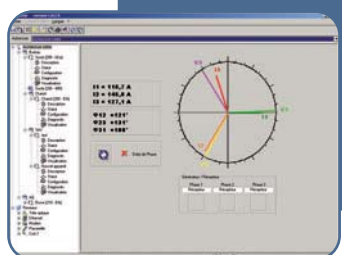

Functionalities	E.Set	E.view	E.view+
Description	•	•	•
Status	•	•	•
Configuration	•	•	•
Diagnosis		•	•
Display		•	•
Graphics			•

T O O R D E R

Model	Reference
E.Set software	P01330501
E.View software	P01330601
E.View+ software	P01330610

FRANCE
Enerdis
 1-9, rue d'Arcueil - BP 675
 92542, MONTROUGE Cedex
 Tel : +33 1 47 46 78 85
 Fax : +33 1 47 35 01 33
 export@enerdis.fr
 www.enerdis.fr

UNITED KINGDOM
Chauvin Arnoux Ltd
 Waldeck House - Waldeck Road
 MAIDENHEAD SL6 8BR
 Tel: +44 1628 788 888
 Fax: +44 1628 628 099
 info@chauvin-arnoux.co.uk
 www.chauvin-arnoux.co.uk

MIDDLE EAST
Chauvin Arnoux Middle East
 P.O. BOX 60-154
 1241 2020 JAL EL DIB (Beirut) - LEBANON
 Tel: +961 1 890 425
 Fax: +961 1 890 424
 camie@chauvin-arnoux.com
 www.chauvin-arnoux.com