

Miniature Circuit Breakers (MCBs) RCCBs/RCBOs Distribution Boards



Innovative products from the town of Lauf

With its product variety of over 5,000 articles, the well-established German company ABL SURSUM supplies the markets throughout the whole world.

ABL SURSUM International Agencies:

throughout Europe	
Egypt	Mexico
Argentina	New Zealand
Azerbaijan	Philippines
Bolivia	Russia
Chile	Singapore
China	South Africa
Georgia	Syria
India	Taiwan
Iran	Thailand
Iceland	Ukraine
Israel	United States
Canada	Venezuela
Kazakhstan	United Arab Emirates
Malaysia	Vietnam
Morocco	

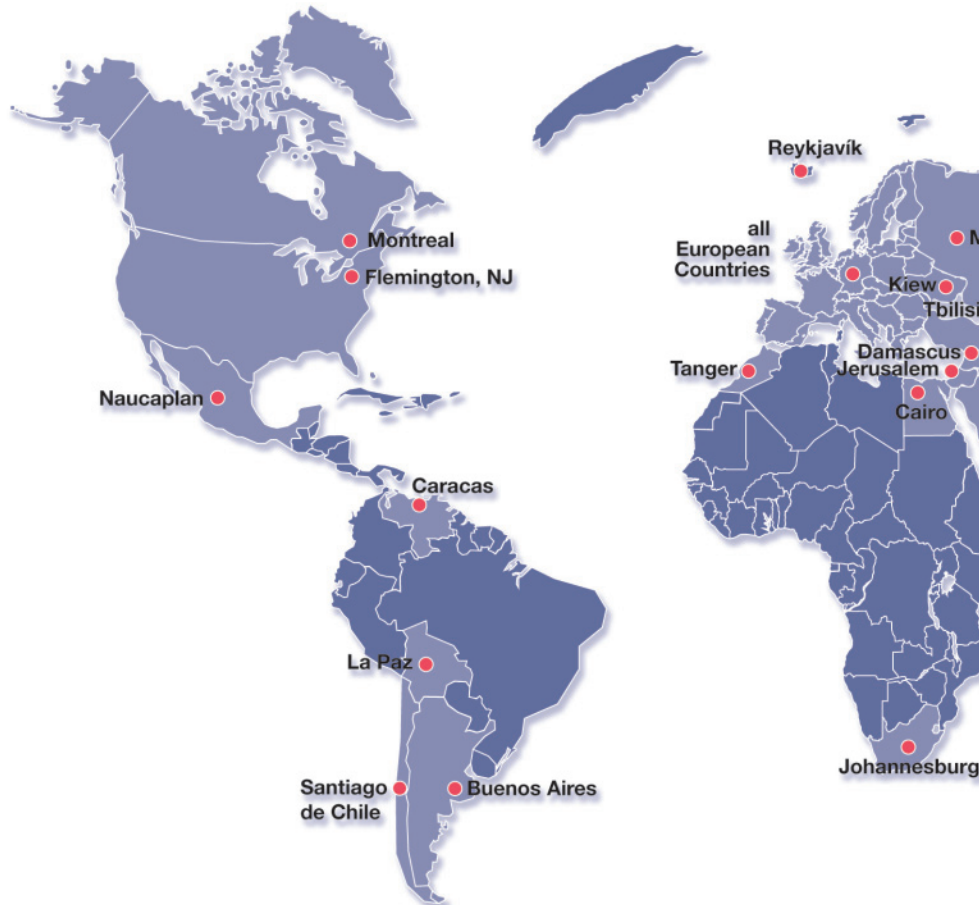

**Tradition – Quality – Innovation – Emotion**

**Dear customers,
Dear business partners,**

These four terms best describe ABL SURSUM products. Using our new catalogues, I would like to show to you why this statement is true.

TRADITION is a commitment which we are proud to make. Being a family company from the very beginning, we have always passed our knowledge on to the next generation. Almost 80 years after the invention of the SCHUKO system, ABL SURSUM provides the most comprehensive range of high-quality plug connections in SCHUKO, Belgian-French earthing systems and other national and international standards.

QUALITY is the decisive criterion for our work. Meeting the highest quality standards, ABL SURSUM products are ideal for the most demanding industrial and trade applications.

INNOVATION is a challenge we accept with every product we develop. Setting market standards with new developments has always been a fundamental concern for ABL SURSUM.

EMOTION to us is the enthusiasm created by a successful product. With its technical innovations and exclusive products, ABL SURSUM constantly strives to create architectural emotion.

With these four considerations in mind, I would like to invite you to discover the tradition and quality as well as the innovation and emotion of ABL SURSUM products in the present catalogue.

Sincerely yours,

Dr. Stefan Schlutius
Managing Director

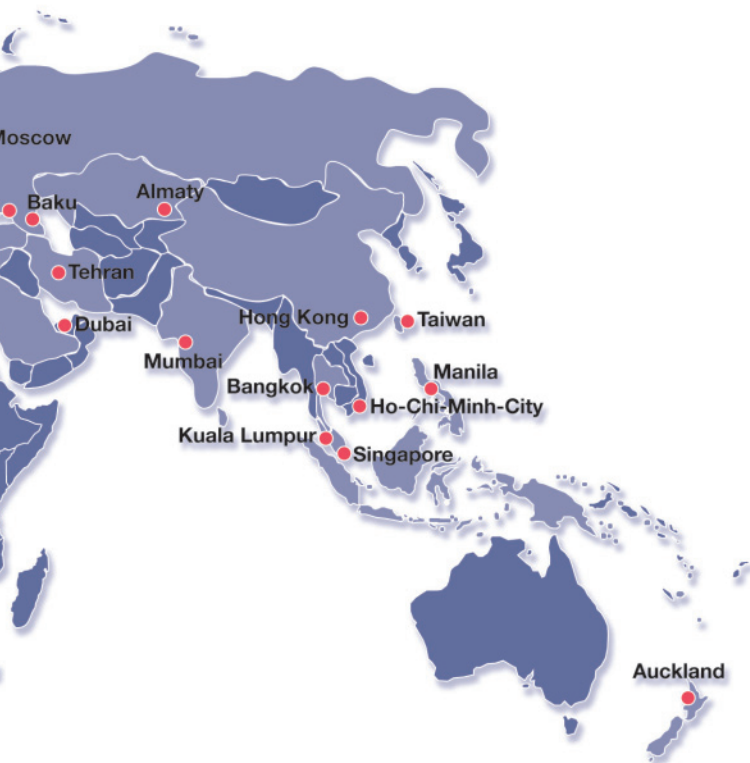

ABL SURSUM has made a key contribution to the history of electrical installation.

It all began in the Twenties, when the founder of ABL, Albert Büttner, developed the basic idea of the earthed plug and socket system known as SCHUKO (Continental Europe style), which is now one of the most commonly used systems in the world.

SURSUM designed the first screw-in circuit breaker with electromagnetic tripping and became a leading manufacturer of circuit breakers. These were just two in a series of major developments that were to follow. The merger of these two successful specialists in 1986 made it possible to supply a seamless range of products – all from the same supplier. Today ABL SURSUM is a very successful company, both nationally and internationally, with about 50 per cent of its turnover coming from exports.



Innovative milestones on the road to today's technology

- 1925** 1st screw-in circuit breaker
- 1926** SCHUKO patent
- 1932** 1st motor protective circuit breaker
- 1935** 1st circuit breaker
- 1966** 1st miniature circuit breaker
- 1979** Industrial plug and socket system according to IEC 309
- 1989** MA motor protective circuit breaker
- 1993** DIN-rail panel products
Miniature circuit breaker according to UL 1077
- 1998** New range of distribution boxes
- 1999** Miniature circuit breaker according to UL 508
- 2001** MS motor protective circuit breaker
- 2002** VDE and UL 508 certificated miniature circuit breaker
- 2004** Appliance connection box with screw-less terminals
Socket outlets in exclusive design
- 2006** New generation of miniature circuit breakers
Data sockets for Industrial Ethernet
- 2007** Compact socket outlets in exclusive design



And now? With the very latest technology all set for the future

Research, development, electrical equipment, tool design, tool construction, pre-fabrication, final assembly, quality assurance, storage, distribution and logistics – we do everything on our own premises. That benefits you and us!

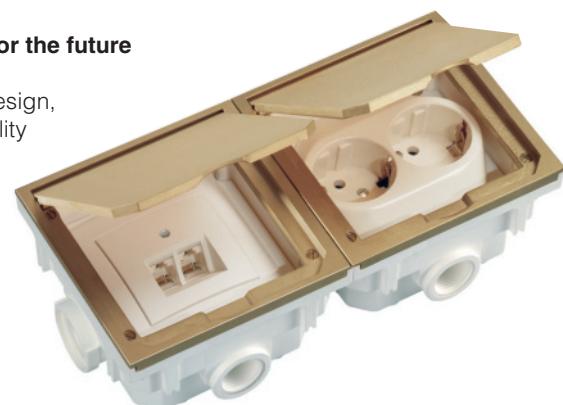

Customer benefit from know-how and experience

The constant high quality of our products is the result of our comprehensive technical know-how and long-standing experience. Product development, in-house tool/equipment manufacturing as well as component manufacturing in plastic and metal engineering, and final assembly: all steps of the value chain are performed at ABL SURSUM. This is what gives us the edge in technical know-how and marketability for the benefit of our customers.

**Development:
Everything on our premises**

Every new product starts with an idea. However, putting ideas into practice requires a lot of experience and the right equipment. This is why the experienced product developers here at ABL SURSUM use only the most modern CAD software while constantly being in touch with customers – because only exact product and market knowledge will result in innovative products suited to requirements.

**Tool and equipment manufacturing:
Quality as the key criterion**

The quality of a manufacturing process starts with the right production facilities. This is why ABL SURSUM builds and maintains their plastic and metal tools in their own facilities. Likewise, a large part of the machines and appliances is built at ABL SURSUM. Because when you plan and build equipment yourself, you are capable of optimum maintenance, continuous further development, and of adapting it to new demands.

**Component manufacturing:
In-house production is better**

Even the smallest component is part of the final product's quality. Therefore, ABL SURSUM produces most of the components for their products on their own premises. In this way, we ensure a seamless and high-quality supply of components for a smooth manufacturing process.

**Final assembly:
Know-how and technology combined**

Experienced, skilled employees and a high degree of automation guarantee on-time production while maintaining a high quality level. Because only high-quality products can compete in the long term.

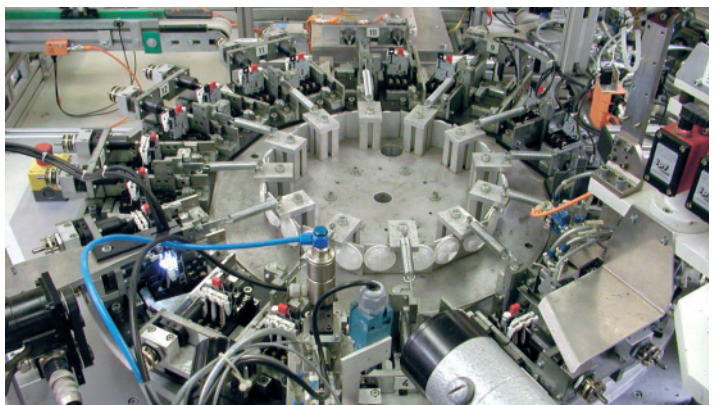
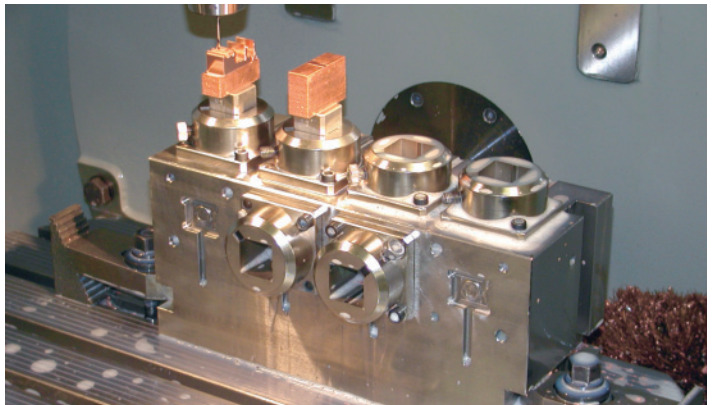

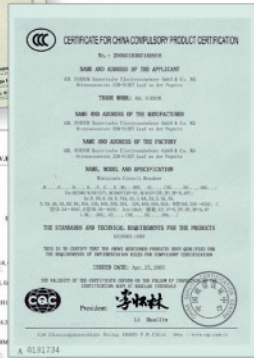
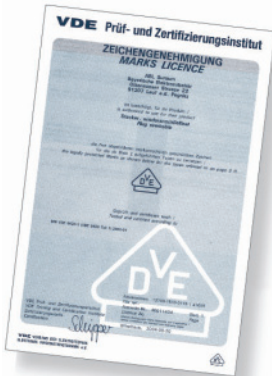

**Quality assurance:
No compromises**

Quality is one of the most central aspects of ABL SURSUM's success story. It is a key element of our philosophy which we adhere to even in times of price-driven marketing strategies. Because long-term success is always related to customer satisfaction and thus to quality and reliability. ABL SURSUM has been DIN ISO 9001 certified for many years, of course.

Permanent quality monitoring using state-of-the-art testing methods is taken for granted at ABL SURSUM. Therefore we accept no compromises in ongoing manufacturing and final inspection. Naturally, our products have all the relevant national and international test seals.



**Logistics:
Service starts at the delivery stage**

In times of ever tighter deadlines, a well-organised sales network, a well-equipped warehouse and modern logistics guarantee on-time delivery both nationally and internationally. Boasting a 50% export percentage, ABL SURSUM supplies numerous customers all over the world punctually every day.

Miniature Circuit Breakers (MCBs)		Page 09 - 29
Description of Miniature Circuit Breakers	Page 10	
Technical Data	Page 14	
“S” Product Range		
B and C Characteristic		
1-pole, 1-pole with switched neutral, 2-pole	Page 21	
3-pole, 3-pole with switched neutral	Page 22	
“SL” Product Range		
B and C Characteristic		
1-pole and 3-pole	Page 23	
“T” Product Range		
B, C, D, K and Z Characteristic		
1-pole, 1-pole with switched neutral	Page 24	
2-pole, 3-pole	Page 25	
3-pole with switched neutral, 4-pole	Page 26	
Accessories		
Shunt trip	Page 27	
Undervoltage trip	Page 27	
Auxiliary contacts	Page 28	
Busbars	Page 29	
Miniature Circuit Breakers (MCBs) / Manual Motor Controller according to UL 508 and CSA-22.2 No.14		Page 31 - 41
Technical Data	Page 33	
B, C, D, E, G and Z Characteristic		
1-pole, 1-pole with switched neutral	Page 37	
2-pole, 3-pole	Page 38	
3-pole with switched neutral	Page 39	
Accessories		
Auxiliary contact	Page 40	
Shunt trip	Page 40	
Busbars	Page 41	
RCCBs and RCBOs		
General Data	Page 44	
RCCBs, Sensitive to Pulsating Currents, Typ A		
Instantaneous tripping	Page 49	
Short-time delayed tripping	Page 50	
Selective tripping	Page 50	
RCCBs, Sensitive to Universal Current, Typ B		
Description	Page 51	
Technical Data	Page 52	
Short-time delayed tripping	Page 53	
Selective tripping	Page 53	
RCBOs		
Technical Data	Page 54	
with MCB 1-pole + N	Page 55	
with MCB 2-pole	Page 55	
Distribution Boards		Page 57 - 63
Description Distribution Boards	Page 58	
Flush mounted Distribution Boards	Page 60	
Hollow-Wall Distribution Boards	Page 60	
Surface mounted Distribution Boards	Page 61	
Accessories	Page 62	
Special Distribution Boards	Page 63	

Description of Miniature Circuit Breakers	Page 10
Technical Data	Page 14
“S” Product Range B and C Characteristic	
- 1-pole, 1-pole with switched neutral, 2-pole	Page 21
- 3-pole, 3-pole with switched neutral	Page 22
“SL” Product Range B and C Characteristic	
- 1-pole, 3-pole	Page 23
“T” Product Range B, C, D, K and Z Characteristic	
- 1-pole, 1-pole with switched neutral	Page 24
- 2-pole, 3-pole	Page 25
- 3-pole with switched neutral, 4-pole	Page 26
Accessories	
- Shunt trip	Page 27
- Undervoltage trip	Page 27
- Auxiliary contacts	Page 28
- Busbars	Page 29



Miniature Circuit Breakers (MCBs)



The next generation in installation technology – innovative and modular miniature circuit breakers from ABL SURSUM.

Building a future means successfully advancing tradition. Circuit breakers are an 80-year-old tradition at ABL SURSUM. The first screw-in circuit breaker came onto the market in 1925. Even then there was thermal and electromagnetic tripping. The first high-performance circuit breaker followed less than 10 years later. A socket circuit breaker, which even achieved the American UL certification. These circuit breakers ushered in the long success story of ABL SURSUM circuit-protection devices.

We are continuing this success story with the new miniature circuit breakers. They combine our experience with the requirements of modern installation technology. With a broad-ranging, product-specific knowledge and in cooperation with our customers, we have developed three innovative product ranges of miniature circuit breakers.

Application-orientation, functionality and the highest quality were just as important as reliable operation, maximum safety and effective time-saving installation.

The result is application-oriented products with a perfect combination of all requirements on the highest quality level and in a modern design. They continue to stand for quality and reliability.



Designed for all electrical engineering applications.

The requirements of modern installation technology were systematically implemented with three product ranges of innovative miniature circuit breakers. Thus the right products can be made available for each project.

The system components which are designed with different functions and performance allow an optimal covering of different applications:

- Conventional house installation.
- Industrial installation.
- Industry applications, machine and system installation.

A future-oriented concept: application-oriented innovations, time-saving easier installation and reliable quality.

The S Range

The installation-friendly 6-kA miniature circuit breakers for house installations.

The SL Range

The innovative 6 kA miniature circuit breakers with screwless top terminal for fast mounting.

The T Range

The flexible 10 kA miniature circuit breakers for industry applications on the highest level.

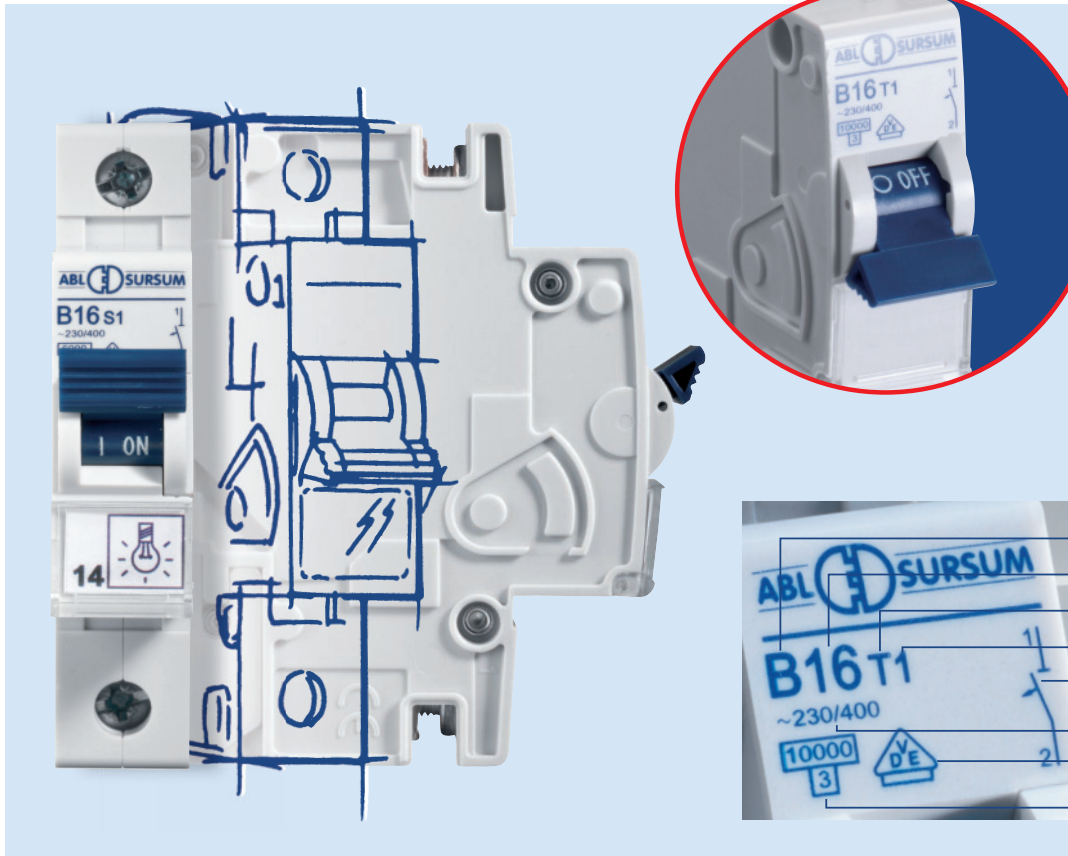

Form and function combined perfectly.

- Compact dimensions (only 83 mm vertical height) for more convenient mounting.
- Modern design, optimum comfort and user-friendliness.
- Easy-to-understand product designations.

B Characteristic
16 Rated current
T Product range
1 No. of poles
 Circuit diagram
 Rated voltage
 Approval
 Rated breaking capacity

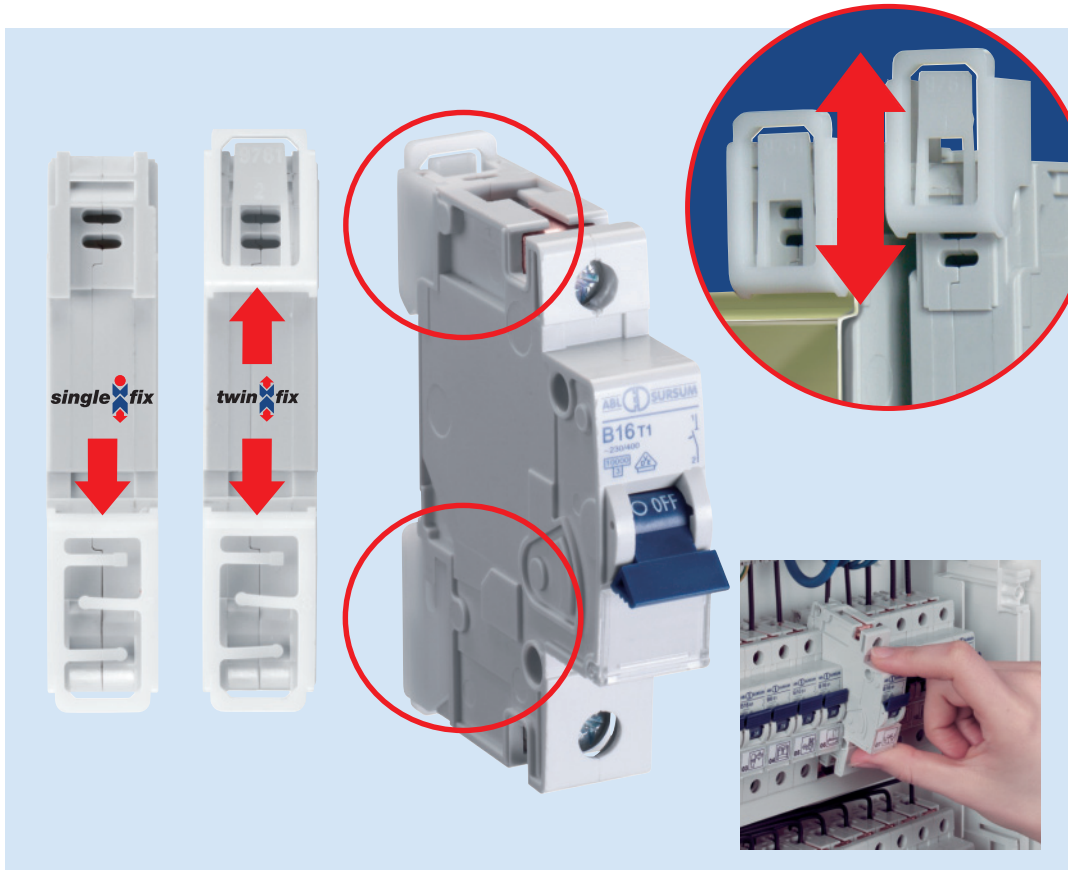

Convenient and time-saving mounting.

- Innovative DIN-rail clip for easy removal from a busbar combination
- No laborious moving of the other components
- T product range with "twin-fix" for removal from the busbar – no matter whether top or bottom-mounted.



- S and SL product ranges with "single-fix" for removal from a bottom-mounted busbar.

plug²power

Fast and safe.

The innovative, screwless "plug2power" connection technology results in safety and more time:

- Fast mounting.
- Highest wiring safety.
- Extreme tensile load capacity.
- Easy to release.
- Integrated test opening for voltage measurement.

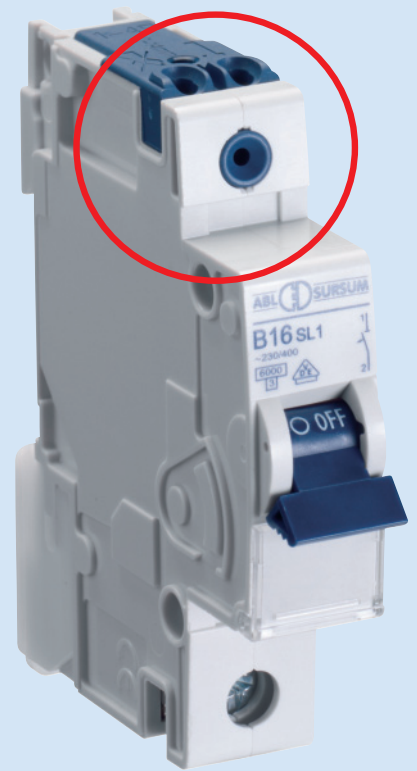
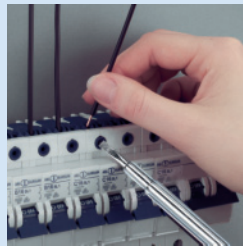
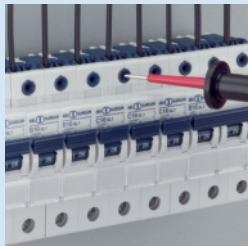
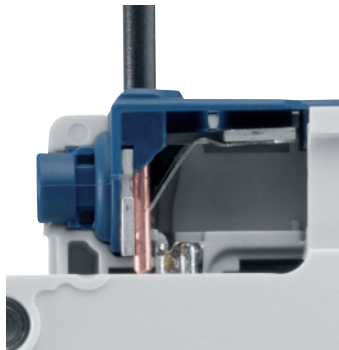

pictoplan

Perfect and compact.

- Optimum labeling possibility.
- User-friendly labeling form.
- Free labeling software.

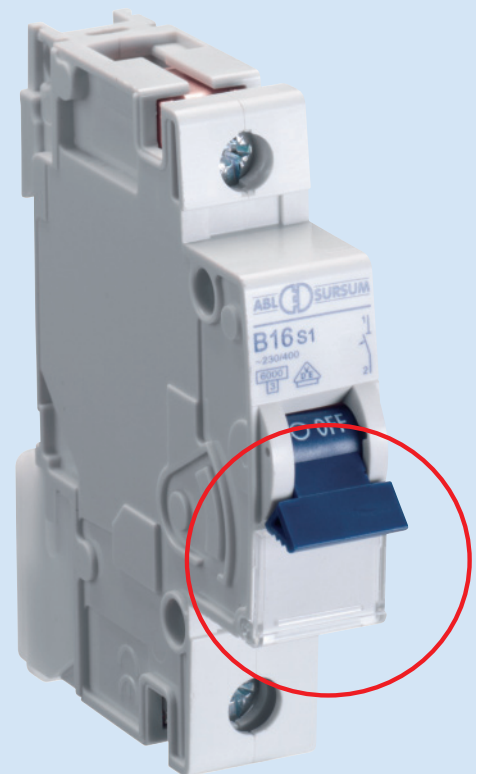
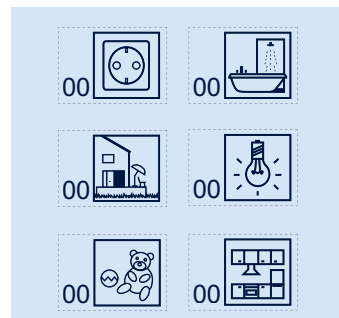

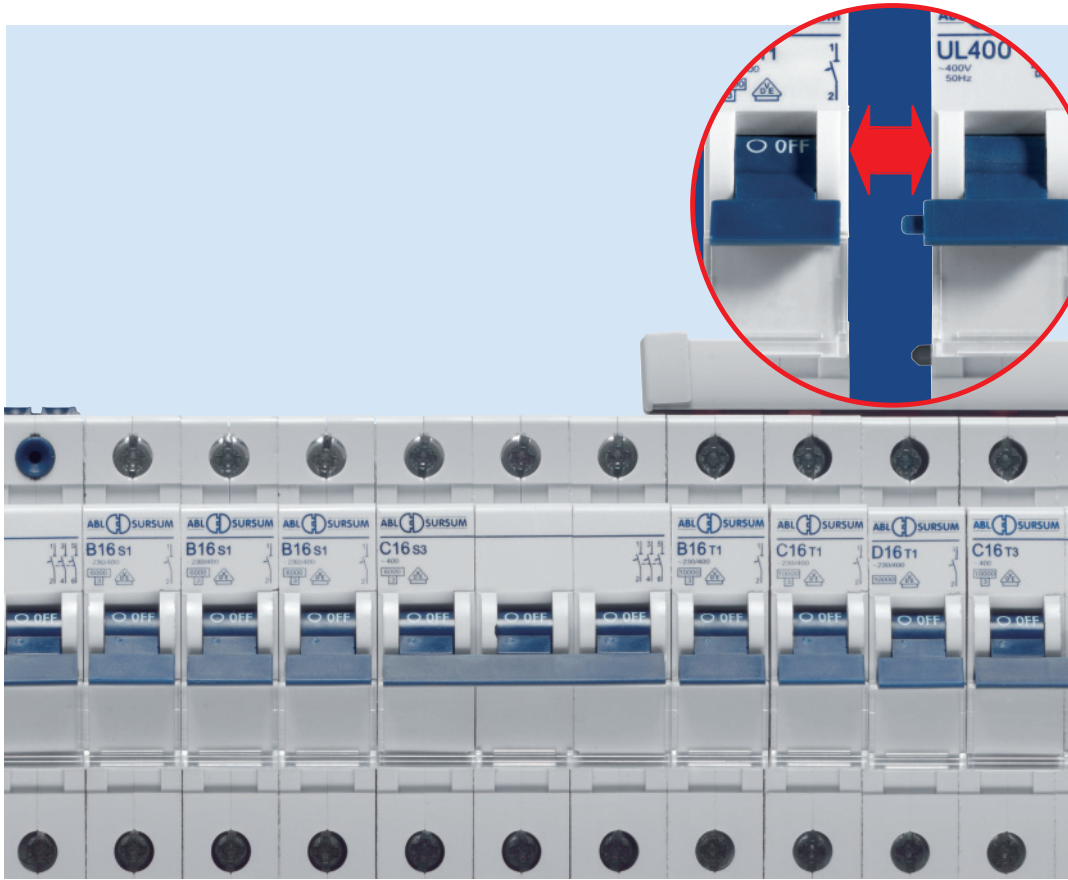

Compatibility without limitations.

- Multi-system compatibility of the S, SL and T product ranges as well as with RCCDs and DIN-rail panel products.
- Suitable for busbar installation with previous products.
- Use of standard busbars.
- Compatibility to available side-by-side-mounting devices.

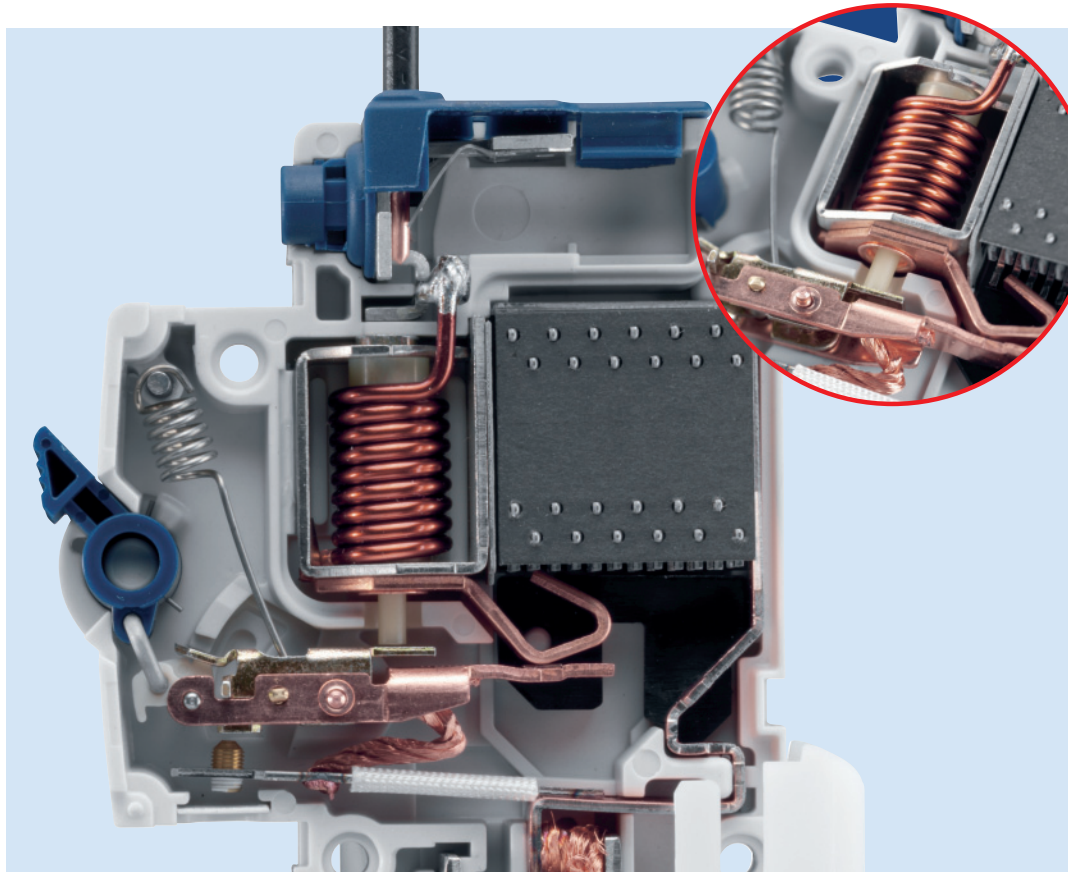

Quality and Safety.

- Highest quality without compromises.
- Maximum protection function.
- Tested three times and independently – fulfilling all standards, approvals and degrees of protection.
- Low maintenance, high life expectancy.



Characteristic	B	C	D	K	Z	
Application	Wiring protection	Wiring protection Device protection	Wiring protection Power circuits Transformers Motors	Wiring protection Power circuits Transformers Motors	Wiring protection Semiconductor protection High impedance	
Number of poles						
Product range „S“	1-3; 1+N; 3+N		-	-	-	
Product range „SL“	1 and 3		-	-	-	
Product range „T“	1 - 4; 1 + N; 3 + N				1 - 3	
Standards short circuit withstand rating	IEC 60898-1, DIN EN 60898-1, VDE 0641-11			IEC 60947-2, DIN EN 60947-2, VDE 0660-101		
Product range „S“	6 kA	6 kA	-	-	-	
Product range „SL“	6 kA	6 kA	-	-	-	
Product range „T“	10 kA	10 kA	10 kA	10 kA	10 kA	
Current limiting class	3					
Max. back-up fuse	Fuse according to DIN VDE 0636 125 A operating class gL/gG					
Rated AC voltage	230 / 400 V					
Rated DC voltage L/R = 4 ms	1-pole 60 V, 2-pole 125 V in serial connection of both poles					
Rated current range I _n						
Product range „S“	6 - 63 A	1 - 63 A	-	-	-	
Product range „SL“	6 - 20 A	6 - 20 A	-	-	-	
Product range „T“	1 - 63 A	0,3 - 63 A	0,3 - 63 A	0,3 - 63 A	0,3 - 32 A	
Test currents	Thermal not tripping I ₁ (A) > 1 h	1,13 x I _n	1,13 x I _n	1,13 x I _n	1,05 x I _n	1,05 x I _n
	Thermal tripping I ₂ (A) < 1 h	1,45 x I _n	1,45 x I _n	1,45 x I _n	1,2 x I _n	1,35 x I _n
	Electromagnetic not tripping I ₄ (A) > 0,1 s	3 x I _n	5 x I _n	10 x I _n	8 x I _n	2 x I _n
	Electromagnetic tripping I ₅ (A) < 0,1 s	5 x I _n	10 x I _n	20 x I _n	12 x I _n	3 x I _n
Reference calibration tempera- ture of the thermal tripping	30° C + 5° C Influence of the ambient temperature on the thermal tripping: Decrease of the current values with higher ambient temperature and increase with lower temperatures of approximately 5% per 10°C difference in temperature					
Frequency range of the electromagnetic trip	16 ² / ₃ to 60 Hz With higher frequencies, the electromagnetic tripping values increase by approximately a factor of 1,1 at 100 Hz; 1,2 at 200 Hz; 1,3 at 300 Hz; 1,4 at 400 Hz; 1,5 for DC					
Ambient temperature	-25° C to +55° C					
Storage temperature	-40° C to +70° C					
Device depth according to DIN 43880	68 mm					
Mechanical endurance	20.000 switching cycles (20.000 ON/20.000 OFF)					
Protection cover	Finger safe and safe to back of hand according to DIN EN 50274/ VDE0660-514, BGV A2					
Insulation group according to DIN VDE 0110	C at 250 V AC, B at 400 V AC					
Degree of protection according to EN / IEC 60529	IP 20					
Installation position	any					
Mounting	DIN-rail according to DIN EN 60715 35 mm					
Lockability	The handle can be secured against manual switching in the on and off position by a lead seal					
Climatic resistance	Humid heat constant according to DIN IEC 60068-2-78 Humid heat cycle according to DIN EN 60068-2-30					
Vibration resistance	> 15 g according to DIN EN 60068-2-59 during a load with I ₁					
Resistance to mechanical shocks	25g 11ms					

Conductor cross sections product ranges S and T				
	Box terminal bottom		Box terminal top	
Type of conductor	max.	min.	max.	min.
Single wire	35 mm ²	0,5 mm ²	25 mm ²	0,5 mm ²
Multiple wire	35 mm ²	1,5 mm ²	25 mm ²	1,5 mm ²
Stranded wire	25 mm ²	1 mm ²	16 mm ²	1 mm ²
Stranded wire with ferrule	16 mm ²	0,5 mm ²	16 mm ²	0,5 mm ²
Busbar cable lug	Up to 3 mm thickness		Up to 3 mm thickness	
Combined, connector and busbar or cable lug	Up to 35 mm ² and up to 2 mm thickness		Up to 25 mm ² and up to 2 mm thickness	
Torque	max. 2 Nm			
Conductor cross sections SL product range				
	Box terminal bottom		Screwless terminal top *)	
Type of conductor	max.	min.	max.	min.
Single wire	35 mm ²	0,5 mm ²	4 mm ²	1 mm ²
Multiple wire	35 mm ²	1,5 mm ²	4 mm ²	1,5 mm ²
Stranded wire	25 mm ²	1 mm ²	4 mm ²	1 mm ²
Stranded wire with ferrule	16 mm ²	0,5 mm ²	2,5 mm ²	1 mm ²
Busbar cable lug	Up to 3 mm thickness		-	
Combined, connector and busbar or cable lug	Up to 35 mm ² and up to 2 mm thickness		-	
Torque	max. 2 Nm		-	

*) Stripped length 12 - 14 mm

Miniature circuit breakers, **S product range**
with screw terminals
can be removed from a **BOTTOM-MOUNTED** busbar
combination

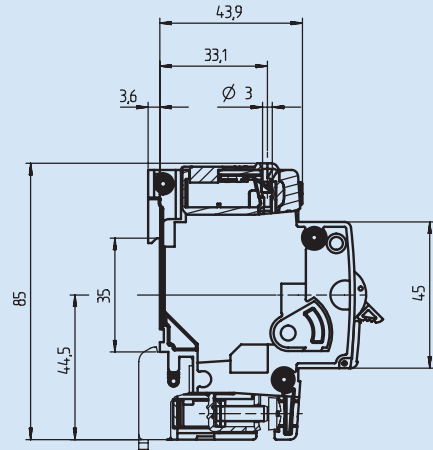
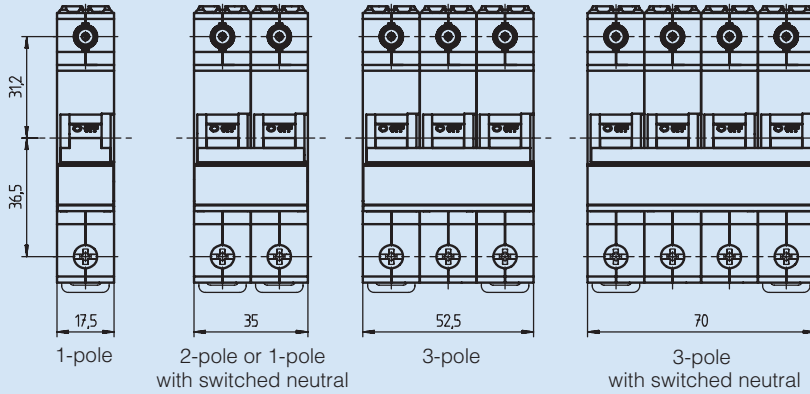

Miniature circuit breakers, **SL product range**
with screwless terminals
can be removed from a **BOTTOM-MOUNTED** busbar
combination

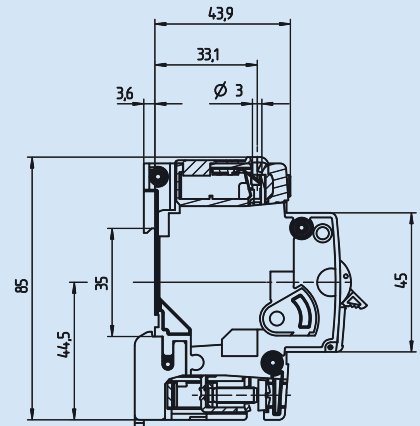
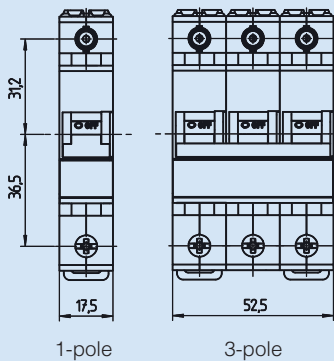

Miniature circuit breakers, **T product range**
with screw terminals
can be removed from a **TOP and BOTTOM-MOUNTED**
busbar combination

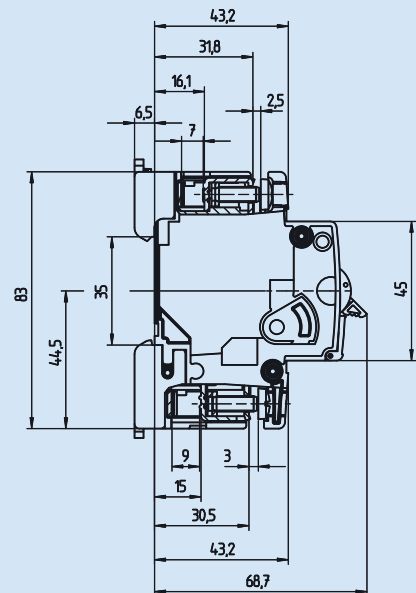
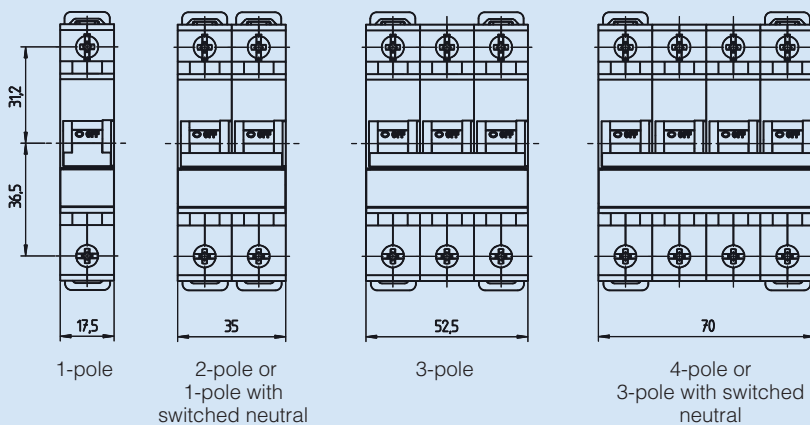

Characteristic

According to IEC 60898-1, DIN EN 60898 and VDE 0641-11

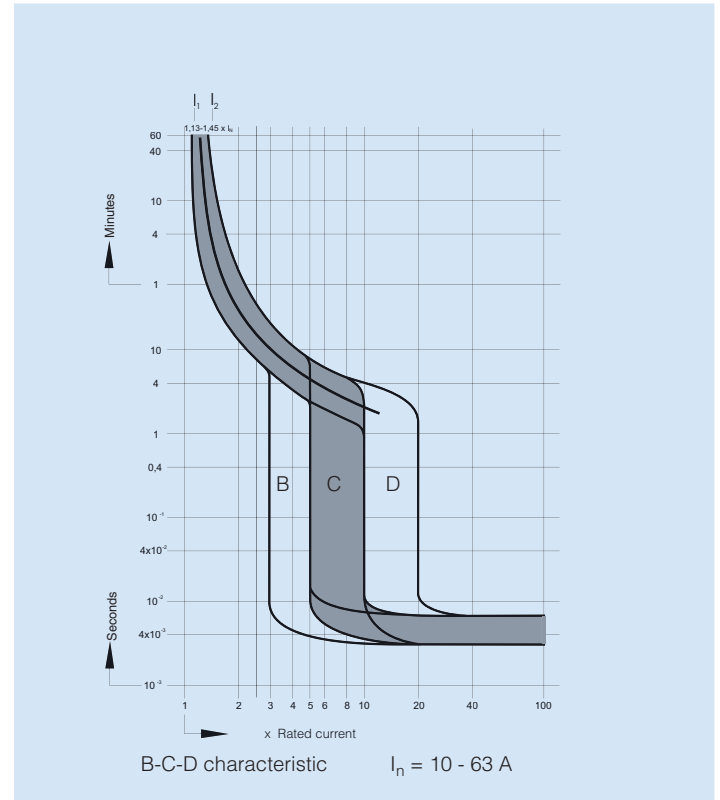
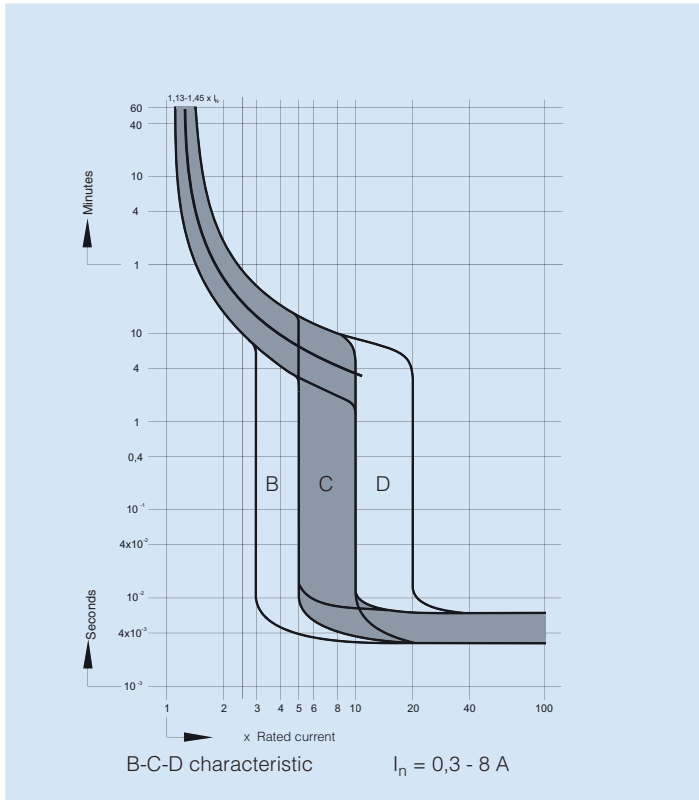

Delayed thermal overload tripping

- I_n = Rated current**
Current which the miniature circuit breaker can sustain in uninterrupted operation
- I_b = Rated operational current**
Current determined by the load during undisturbed operation
- I_1 = Thermal not tripping current**
Current which, under defined conditions, does not lead to switching off within 60 min
- I_2 = Thermal tripping current**
Current which, under defined conditions, leads to switching off within 60 min
- I_1 to I_2 = Conditions**
Current which, under defined conditions, is run up from I_1 to I_2 with a continuous increase, and leads to switch off within 60 min
- I_3 = Tolerance limitation at 2,55-times the rated current/ nominal current**
Current which, under defined conditions, does not lead to switch off within 1 sec
Current which, under defined conditions, leads to switch off at rated currents up to 32 A within 60 sec, at rated currents above 32A within 120 sec

Undelayed electromagnetic short circuit tripping

- I_4 = Magnetic not tripping current**
Current which, under defined conditions, does not lead to switching off within 0,1 sec
- I_5 = Magnetic tripping current**
Current which, under defined conditions, leads to switching off within 0,1 sec

Dependence of the short circuit trip at higher frequencies and for direct current.

at 100 Hz about 1,1 times
 at 200 Hz about 1,2 times
 at 300 Hz about 1,3 times
 at 400 Hz about 1,4 times
 at 500 Hz about 1,5 times
 for DC about 1,5 times

Characteristic

According to IEC 60947-2, DIN EN 60947-2 and VDE 0660-101

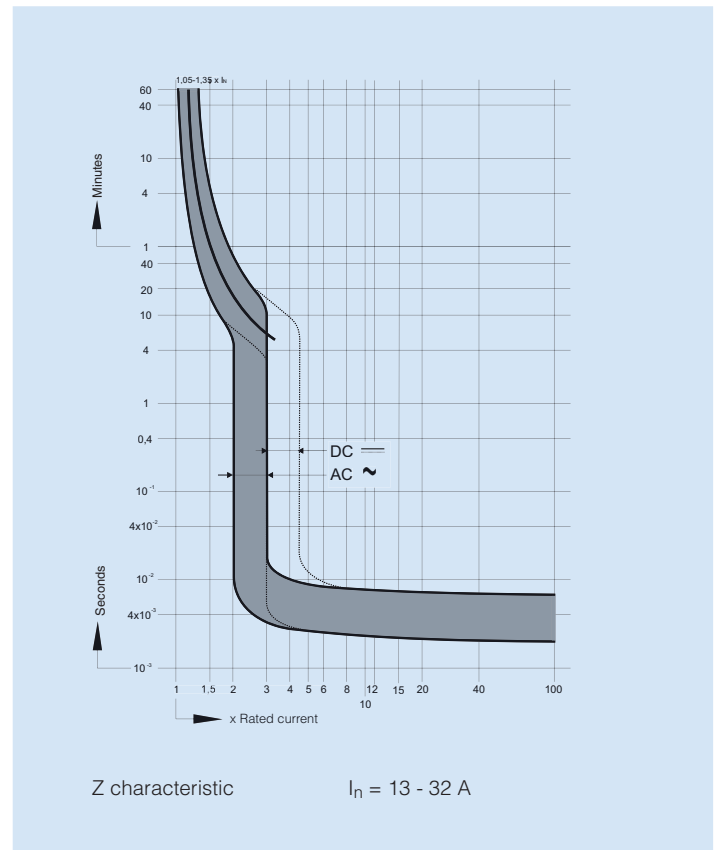
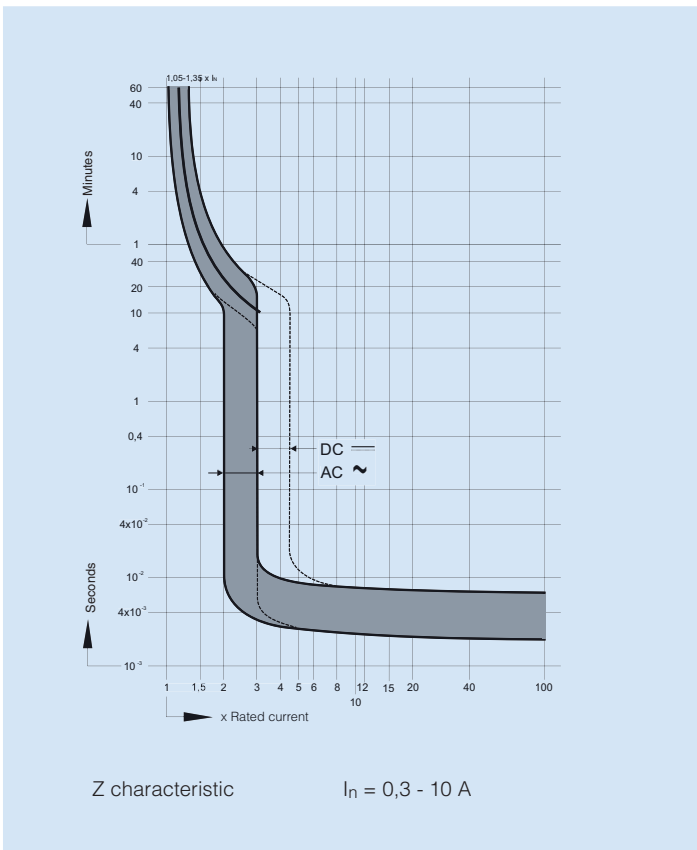
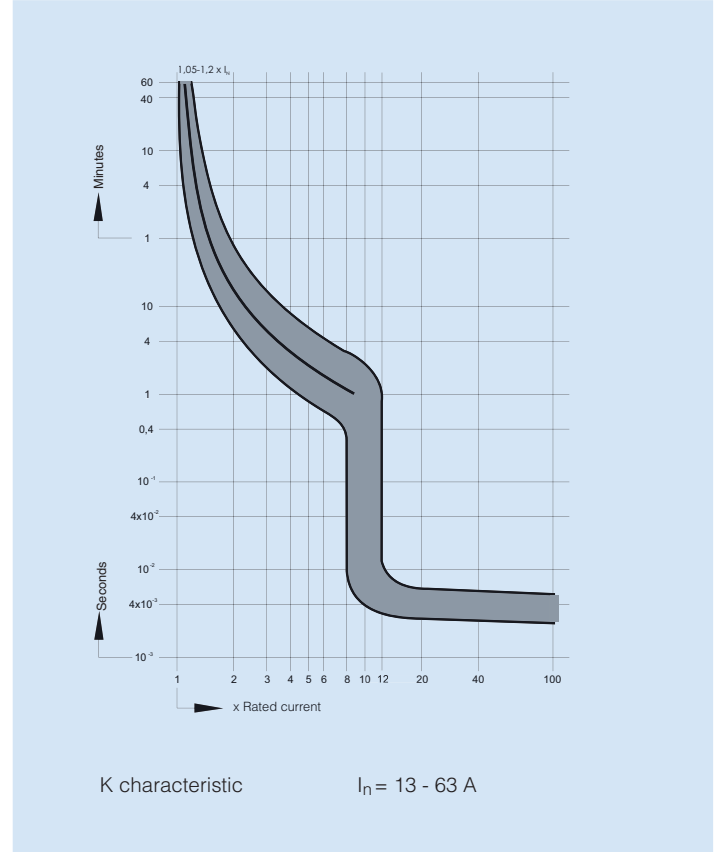
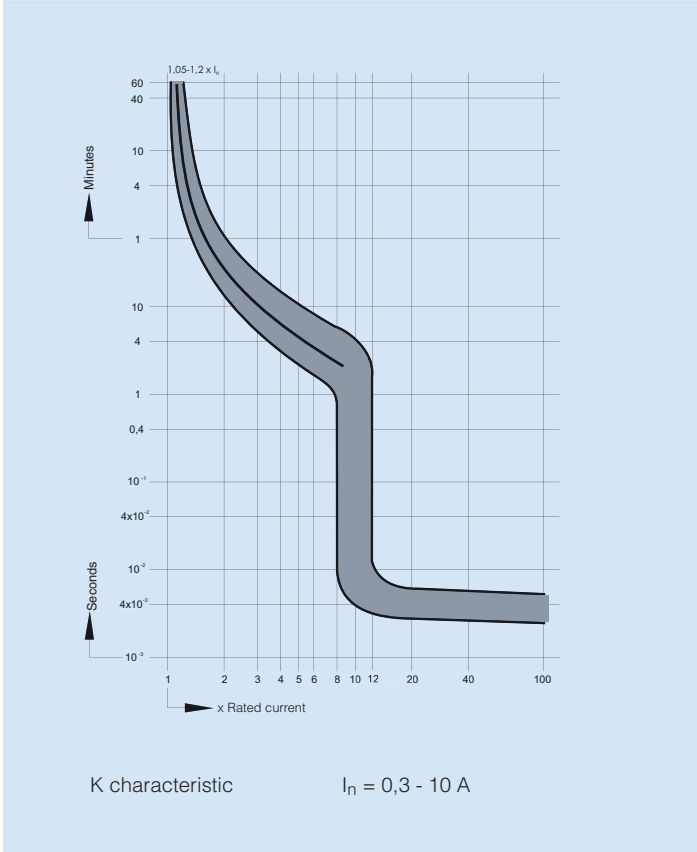

Internal resistances in mOhm and power losses in Watt per pole (at I_n)

Rated current I _n (A)	B-characteristic		C-characteristic		D-characteristic		K-characteristic		Z-characteristic	
	Internal resistance mOhm	Power loss Watt	Internal resistance mOhm	Power loss Watt	Internal resistance mOhm	Power loss Watt	Internal resistance mOhm	Power loss Watt	Internal resistance mOhm	Power loss Watt
0,3	-	-	16600	1,5	16600,0	1,5	16860,0	1,5	31500,0	2,8
0,5	-	-	6850	1,7	6850,0	1,7	6850,0	1,7	10250,0	2,6
0,8	-	-	3050	2,0	3050,0	2,0	3050,0	2,0	5150,0	3,3
1	1950	2,0	1750	1,8	1750,0	1,8	1750,0	1,8	2690,0	2,7
1,6	720	1,8	590	1,5	590,0	1,5	590,0	1,5	940,0	2,4
2	510	2,0	420	1,7	420,0	1,7	420,0	1,7	690,0	2,8
2,5	325	2,0	295	1,8	295,0	1,8	295,0	1,8	430,0	2,7
3	211	1,9	200	1,8	173,0	1,6	200,0	1,8	345,0	3,1
3,5	159	1,9	125	1,5	125,0	1,5	125,0	1,5	225,0	2,8
4	131	2,1	109	1,7	105,0	1,7	109,0	1,7	225,0	3,6
5	85	2,1	61,6	1,5	61,6	1,5	65,4	1,6	105,0	2,6
6	52,9	1,9	49,1	1,8	45,9	1,7	49,1	1,8	82,3	3,0
8	26	1,7	24	1,5	20,7	1,3	44,0	2,8	37,1	2,4
10	13,4	1,3	13,4	1,3	13,4	1,3	31,5	3,1	27,8	2,8
13	11,3	1,9	8,04	1,4	8,1	1,4	8,8	1,5	15,1	2,6
16	8,04	2,1	8,04	2,1	8,1	2,1	7,5	1,9	11,3	2,9
20	7,1	2,8	7,45	3,0	6,4	2,5	6,3	2,5	7,4	3,0
25	5	3,1	5	3,1	4,1	2,5	4,7	2,9	5,8	3,7
32	3,6	3,7	3,6	3,7	2,7	2,8	2,8	2,9	3,6	3,7
40	2,2	3,5	2,2	3,5	2,2	3,5	2,2	3,5	-	-
50	1,95	4,9	1,9	4,8	1,8	4,6	2,0	4,9	-	-
63	1,77	7,0	1,77	7,0	1,7	6,8	1,8	7,0	-	-

Overload and short circuit currents

I _n (A)	Overload						Short circuit									
	B,C,D		K		Z		B		C		D		K		Z	
	I ₁	I ₂	I ₁	I ₂	I ₁	I ₂	I ₄	I ₅	I ₄	I ₅	I ₄	I ₅	I ₄	I ₅	I ₄	I ₅
0,3	0,339	0,435	0,315	0,360	0,315	0,405	0,9	1,5	1,5	3	3	6	2,4	3,6	0,6	0,9
0,5	0,565	0,725	0,525	0,600	0,525	0,675	1,5	2,5	2,5	5	5	10	4	6	1	1,5
0,75	0,848	1,088	0,788	0,900	0,788	1,013	2,25	3,75	3,75	7,5	7,5	15	6	9	1,5	2,25
1	1,13	1,45	1,05	1,20	1,05	1,35	3	5	5	10	10	20	8	12	2	3
1,6	1,81	2,32	1,68	1,92	1,68	2,16	4,8	8	8	16	16	32	12,8	19,2	3,2	4,8
2	2,26	2,90	2,10	2,40	2,10	2,70	6	10	10	20	20	40	16	24	4	6
2,5	2,83	3,63	2,63	3,00	2,63	3,38	7,5	12,5	12,5	25	25	50	20	30	5	7,5
3	3,39	4,35	3,15	3,60	3,15	4,05	9	15	15	30	30	60	24	36	6	9
3,5	3,96	5,08	3,68	4,20	3,68	4,73	10,5	17,5	17,5	35	35	70	28	42	7	10,5
4	4,52	5,80	4,20	4,80	4,20	5,40	12	20	20	40	40	80	32	48	8	12
5	5,65	7,25	5,25	6,00	5,25	6,75	15	25	25	50	50	100	40	60	10	15
6	6,78	8,70	6,30	7,20	6,30	8,10	18	30	30	60	60	120	48	72	12	18
8	9,04	11,60	8,40	9,60	8,40	10,80	24	40	40	80	80	160	64	96	16	24
10	11,3	14,5	10,5	12,0	10,5	13,5	30	50	50	100	100	200	80	120	20	30
13	14,7	18,9	13,7	15,6	13,7	17,6	39	65	65	130	130	260	104	156	26	39
16	18,1	23,2	16,8	19,2	16,8	21,6	48	80	80	160	160	320	128	192	32	48
20	22,6	29,0	21,0	24,0	21,0	27,0	60	100	100	200	200	400	160	240	40	60
25	28,3	36,3	26,3	30,0	26,3	33,8	75	125	125	250	250	500	200	300	50	75
32	36,2	46,4	33,6	38,4	33,6	43,2	96	160	160	320	320	640	256	384	64	96
40	45,2	58,0	42,0	48,0	-	-	120	200	200	400	400	800	320	480	-	-
50	56,5	72,5	52,5	60,0	-	-	150	250	250	500	500	1000	400	600	-	-
63	71,2	91,4	66,2	75,6	-	-	189	315	315	630	630	1260	504	756	-	-

Short circuit selectivity

10 kA miniature circuit breakers, T product range Short circuit selectivity to fuses in kA

		Rated current I _n (A)													
Characteristic	B	6	10	13	16	20	25	32	40	50	63				
	C	6	10	13	16	20	25	32	40	50	63	63	63		
D	6/8	6/8	10	13	16	20	25	32	40	50	63	63	63		
I _n (A)	LV HRC fuse Characteristic gL/gG according to DIN VDE 0636	25	0,85 0,7 0,7	0,8 0,7 0,6	0,8 0,7 0,6	0,75 0,65 0,6	0,7 0,6 0,55	0,6 0,55 0,5						1.)	
		35	1,6 1,3 1,2	1,6 1,3 1,15	1,5 1,25 1,1	1,5 1,2 1,1	1,4 1,2 1,0	1,2 1,1 0,9	1,1 1,0 0,8	0,8 0,7 0,5					
		50	2,4 2,1 1,9	2,35 2,1 1,8	2,3 2,0 1,7	2,3 2,0 1,7	2,2 1,9 1,6	1,6 1,5 1,3	1,5 1,4 1,2	1,3 1,2 1,1	1,2 1,1 1,0				
		63	3,5 2,9 2,5	3,3 2,8 2,4	3,2 2,7 2,4	3,2 2,7 2,3	3,0 2,6 2,3	2,5 2,1 1,8	2,4 2,0 1,8	1,8 1,6 1,4	1,7 1,5 1,3	1,6 1,4 1,2			
		80	5,0 4,1 3,5	4,8 4,0 3,4	4,7 3,9 3,3	4,6 3,9 3,2	4,3 3,6 3,1	3,4 2,8 2,5	3,3 2,8 2,4	2,5 2,1 1,9	2,4 2,0 1,8	2,3 1,9 1,7			
		100	7,6 6,3 5,2	7,3 6,1 4,9	7,1 5,9 4,8	7,0 5,7 4,7	6,5 5,0 4,4	5,1 4,0 3,5	5,0 3,9 3,4	3,5 2,9 2,5	3,3 2,8 2,4	3,1 2,6 2,3			
		125	10 10 8,8	10 10 8,0	10 10 7,7	10 10 7,6	10 8,7 7,1	8,8 6,9 5,7	8,5 6,8 5,6	5,4 4,5 3,8	5,1 4,3 3,6	4,9 4,1 3,5			

1.) There is no more overload selectivity above the step line.

6 kA miniature circuit breakers, S and SL product ranges Short circuit selectivity to fuses in kA

		Rated current I _n (A)												
Characteristic	B	6	10	13	16	20	25	32	40	50	63			
	C	6	10	13	16	20	25	32	40	50	63	63	63	
I _n (A)	LV HRC fuse Characteristic gL/gG according to DIN VDE 0636	25	0,85 0,7	0,8 0,7	0,8 0,7	0,75 0,65	0,7 0,6	0,6 0,55						1.)
		35	1,6 1,3	1,6 1,3	1,5 1,25	1,5 1,2	1,4 1,2	1,2 1,1	1,1 1,0	0,8 0,7				
		50	2,4 2,1	2,35 2,1	2,3 2,0	2,3 2,0	2,2 1,9	1,6 1,5	1,5 1,4	1,3 1,2	1,2 1,1			
		63	3,5 2,9	3,3 2,8	3,2 2,7	3,2 2,7	3,0 2,6	2,5 2,1	2,4 2,0	1,8 1,6	1,7 1,5	1,6 1,4		
		80	5,0 4,1	4,8 4,0	4,7 3,9	4,6 3,9	4,3 3,6	3,4 2,8	3,3 2,8	2,5 2,1	2,4 2,0	2,3 1,9		
		100					6,0 5,0	5,1 4,0	5,0 3,9	3,5 2,9	3,3 2,8	3,1 2,6		

1.) There is no more overload selectivity above the step line.

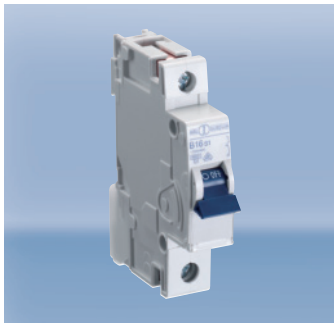

single **fix**

Rated current I_n A	Characteristic		Weight g/each	Packing unit
	B Article no.	C Article no.		

1-pole				
1		C1S1	120	12
2		C2S1	120	12
3		C3S1	120	12
4		C4S1	120	12
5		C5S1	120	12
6	B6S1	C6S1	120	12
10	B10S1	C10S1	120	12
13	B13S1	C13S1	120	12
16	B16S1	C16S1	120	12
20	B20S1	C20S1	120	12
25	B25S1	C25S1	120	12
32	B32S1	C32S1	120	12
40	B40S1	C40S1	125	12
50	B50S1	C50S1	135	12
63	B63S1	C63S1	135	12

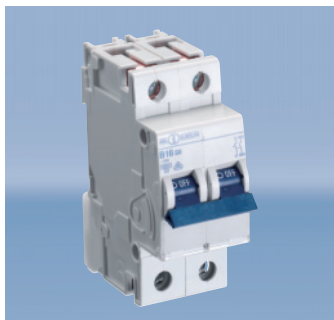

single **fix**

1-pole with switched neutral				
1		C1S8	240	6
2		C2S8	240	6
3		C3S8	240	6
4		C4S8	240	6
5		C5S8	240	6
6	B6S8	C6S8	240	6
10	B10S8	C10S8	240	6
13	B13S8	C13S8	240	6
16	B16S8	C16S8	240	6
20	B20S8	C20S8	240	6
25	B25S8	C25S8	240	6
32	B32S8	C32S8	240	6
40	B40S8	C40S8	250	6
50	B50S8	C50S8	270	6
63	B63S8	C63S8	270	6

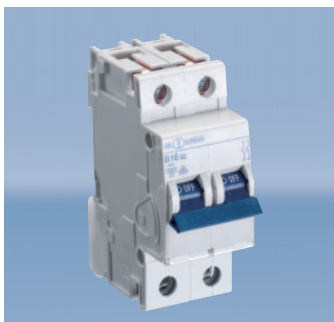

single **fix**

2-pole				
1		C1S2	240	6
2		C2S2	240	6
3		C3S2	240	6
4		C4S2	240	6
5		C5S2	240	6
6	B6S2	C6S2	240	6
10	B10S2	C10S2	240	6
13	B13S2	C13S2	240	6
16	B16S2	C16S2	240	6
20	B20S2	C20S2	240	6
25	B25S2	C25S2	240	6
32	B32S2	C32S2	240	6
40	B40S2	C40S2	250	6
50	B50S2	C50S2	270	6
63	B63S2	C63S2	270	6



single  **fix**



single  **fix**

Rated current I_n A	Characteristic		Weight g/each	Packing unit
	B Article no.	C Article no.		

3-pole

1		C1S3	360	4
2		C2S3	360	4
3		C3S3	360	4
4		C4S3	360	4
5		C5S3	360	4
6	B6S3	C6S3	360	4
10	B10S3	C10S3	360	4
13	B13S3	C13S3	360	4
16	B16S3	C16S3	360	4
20	B20S3	C20S3	360	4
25	B25S3	C25S3	360	4
32	B32S3	C32S3	360	4
40	B40S3	C40S3	375	4
50	B50S3	C50S3	405	4
63	B63S3	C63S3	405	4

3-pole

with switched neutral				
1		C1S9	480	3
2		C2S9	480	3
3		C3S9	480	3
4		C4S9	480	3
5		C5S9	480	3
6	B6S9	C6S9	480	3
10	B10S9	C10S9	480	3
13	B13S9	C13S9	480	3
16	B16S9	C16S9	480	3
20	B20S9	C20S9	480	3
25	B25S9	C25S9	480	3
32	B32S9	C32S9	480	3
40	B40S9	C40S9	500	3
50	B50S9	C50S9	540	3
63	B63S9	C63S9	540	3

Miniature Circuit Breakers SL Product Range

With screwless top terminal (plug2power)
6 kA B and C characteristic according to IEC 60898-1, DIN EN 60898-1, VDE 0641-11

plug2power

“plug2power”
The innovative screwless terminal technology
for fast and safe connections



Rated current I_n A	Characteristic		Weight g/each	Packing unit
	B Article no.	C Article no.		

1-pole

6	B6SL1	C6SL1	120	12
10	B10SL1	C10SL1	120	12
13	B13SL1	C13SL1	120	12
16	B16SL1	C16SL1	120	12
20	B20SL1	C20SL1	120	12

single  **fix**

3-pole

6	B6SL3	C6SL3	360	4
10	B10SL3	C10SL3	360	4
13	B13SL3	C13SL3	360	4
16	B16SL3	C16SL3	360	4
20	B20SL3	C20SL3	360	4

single  **fix**

Miniature Circuit Breakers T Product Range

10kA B, C and D characteristic according to IEC 60898-1, DIN EN 60898-1, VDE 0641-11
10kA K and Z characteristic according to IEC 60947-2, DIN EN 60947-2, VDE 0660-101

This product range differentiates between:

- standard products for normal market applications (**shown in the table in bold**)
- exclusive products for branch-specific applications (shown in the table in normal print)



Rated current I_n A	Characteristic					Weight g/each	Packing unit
	B Article no.	C Article no.	D Article no.	K Article no.	Z Article no.		

1-pole							
0,3		C0.3T1	D0.3T1	K0.3T1	Z0.3T1	120	12
0,5		C0.5T1	D0.5T1	K0.5T1	Z0.5T1	120	12
0,8		C0.8T1	D0.8T1	K0.8T1	Z0.8T1	120	12
1	B1T1	C1T1	D1T1	K1T1	Z1T1	120	12
1,6		C1.6T1	D1.6T1	K1.6T1	Z1.6T1	120	12
2	B2T1	C2T1	D2T1	K2T1	Z2T1	120	12
2,5		C2.5T1	D2.5T1	K2.5T1	Z2.5T1	120	12
3	B3T1	C3T1	D3T1	K3T1	Z3T1	120	12
3,5		C3.5T1	D3.5T1	K3.5T1	Z3.5T1	120	12
4	B4T1	C4T1	D4T1	K4T1	Z4T1	120	12
5	B5T1	C5T1	D5T1	K5T1	Z5T1	120	12
6	B6T1	C6T1	D6T1	K6T1	Z6T1	120	12
8		C8T1	D8T1	K8T1	Z8T1	120	12
10	B10T1	C10T1	D10T1	K10T1	Z10T1	120	12
13	B13T1	C13T1	D13T1	K13T1	Z13T1	120	12
16	B16T1	C16T1	D16T1	K16T1	Z16T1	120	12
20	B20T1	C20T1	D20T1	K20T1	Z20T1	120	12
25	B25T1	C25T1	D25T1	K25T1	Z25T1	120	12
32	B32T1	C32T1	D32T1	K32T1	Z32T1	120	12
40	B40T1	C40T1	D40T1	K40T1		125	12
50	B50T1	C50T1	D50T1	K50T1		135	12
63	B63T1	C63T1	D63T1	K63T1		135	12



1-pole with switched neutral							
0,3		C0.3T8	D0.3T8	K0.3T8		240	6
0,5		C0.5T8	D0.5T8	K0.5T8		240	6
0,8		C0.8T8	D0.8T8	K0.8T8		240	6
1	B1T8	C1T8	D1T8	K1T8		240	6
1,6		C1.6T8	D1.6T8	K1.6T8		240	6
2	B2T8	C2T8	D2T8	K2T8		240	6
2,5		C2.5T8	D2.5T8	K2.5T8		240	6
3	B3T8	C3T8	D3T8	K3T8		240	6
3,5		C3.5T8	D3.5T8	K3.5T8		240	6
4	B4T8	C4T8	D4T8	K4T8		240	6
5	B5T8	C5T8	D5T8	K5T8		240	6
6	B6T8	C6T8	D6T8	K6T8		240	6
8		C8T8	D8T8	K8T8		240	6
10	B10T8	C10T8	D10T8	K10T8		240	6
13	B13T8	C13T8	D13T8	K13T8		240	6
16	B16T8	C16T8	D16T8	K16T8		240	6
20	B20T8	C20T8	D20T8	K20T8		240	6
25	B25T8	C25T8	D25T8	K25T8		240	6
32	B32T8	C32T8	D32T8	K32T8		240	6
40	B40T8	C40T8	D40T8	K40T8		250	6
50	B50T8	C50T8	D50T8	K50T8		270	6
63	B63T8	C63T8	D63T8	K63T8		270	6

Miniature Circuit Breakers T Product Range

10 kA B, C and D characteristic according to IEC 60898-1, DIN EN 60898-1, VDE 0641-11
10 kA K and Z characteristic according to IEC 60947-2, DIN EN 60947-2, VDE 0660-101

This product range differentiates between:

- standard products for normal market applications (**shown in the table in bold**)
- exclusive products for branch-specific applications (shown in the table in normal print)



Rated current I_n A	Characteristic					Weight g/each	Packing unit
	B Article no.	C Article no.	D Article no.	K Article no.	Z Article no.		

2-pole

0,3		C0.3T2	D0.3T2	K0.3T2	Z0.3T2	240	6
0,5		C0.5T2	D0.5T2	K0.5T2	Z0.5T2	240	6
0,8		C0.8T2	D0.8T2	K0.8T2	Z0.8T2	240	6
1	B1T2	C1T2	D1T2	K1T2	Z1T2	240	6
1,6		C1.6T2	D1.6T2	K1.6T2	Z1.6T2	240	6
2	B2T2	C2T2	D2T2	K2T2	Z2T2	240	6
2,5		C2.5T2	D2.5T2	K2.5T2	Z2.5T2	240	6
3	B3T2	C3T2	D3T2	K3T2	Z3T2	240	6
3,5		C3.5T2	D3.5T2	K3.5T2	Z3.5T2	240	6
4	B4T2	C4T2	D4T2	K4T2	Z4T2	240	6
5	B5T2	C5T2	D5T2	K5T2	Z5T2	240	6
6	B6T2	C6T2	D6T2	K6T2	Z6T2	240	6
8		C8T2	D8T2	K8T2	Z8T2	240	6
10	B10T2	C10T2	D10T2	K10T2	Z10T2	240	6
13	B13T2	C13T2	D13T2	K13T2	Z13T2	240	6
16	B16T2	C16T2	D16T2	K16T2	Z16T2	240	6
20	B20T2	C20T2	D20T2	K20T2	Z20T2	240	6
25	B25T2	C25T2	D25T2	K25T2	Z25T2	240	6
32	B32T2	C32T2	D32T2	K32T2	Z32T2	240	6
40	B40T2	C40T2	D40T2	K40T2		250	6
50	B50T2	C50T2	D50T2	K50T2		270	6
63	B63T2	C63T2	D63T2	K63T2		270	6

3-pole

0,3		C0.3T3	D0.3T3	K0.3T3	Z0.3T3	360	4
0,5		C0.5T3	D0.5T3	K0.5T3	Z0.5T3	360	4
0,8		C0.8T3	D0.8T3	K0.8T3	Z0.8T3	360	4
1	B1T3	C1T3	D1T3	K1T3	Z1T3	360	4
1,6		C1.6T3	D1.6T3	K1.6T3	Z1.6T3	360	4
2	B2T3	C2T3	D2T3	K2T3	Z2T3	360	4
2,5		C2.5T3	D2.5T3	K2.5T3	Z2.5T3	360	4
3	B3T3	C3T3	D3T3	K3T3	Z3T3	360	4
3,5		C3.5T3	D3.5T3	K3.5T3	Z3.5T3	360	4
4	B4T3	C4T3	D4T3	K4T3	Z4T3	360	4
5	B5T3	C5T3	D5T3	K5T3	Z5T3	360	4
6	B6T3	C6T3	D6T3	K6T3	Z6T3	360	4
8		C8T3	D8T3	K8T3	Z8T3	360	4
10	B10T3	C10T3	D10T3	K10T3	Z10T3	360	4
13	B13T3	C13T3	D13T3	K13T3	Z13T3	360	4
16	B16T3	C16T3	D16T3	K16T3	Z16T3	360	4
20	B20T3	C20T3	D20T3	K20T3	Z20T3	360	4
25	B25T3	C25T3	D25T3	K25T3	Z25T3	360	4
32	B32T3	C32T3	D32T3	K32T3	Z32T3	360	4
40	B40T3	C40T3	D40T3	K40T3		375	4
50	B50T3	C50T3	D50T3	K50T3		405	4
63	B63T3	C63T3	D63T3	K63T3		405	4



Miniature Circuit Breakers T Product Range

10kA B, C and D characteristic according to IEC 60898-1, DIN EN 60898-1, VDE 0641-11
10kA K and Z characteristic according to IEC 60947-2, DIN EN 60947-2, VDE 0660-101

This product range differentiates between:

- standard products for normal market applications (**shown in the table in bold**)
- exclusive products for branch-specific applications (shown in the table in normal print)



Rated current I_n A	B Article no.	C Article no.	Characteristic D Article no.	K Article no.	Z Article no.	Weight g/each	Packing unit
--------------------------	------------------	------------------	------------------------------------	------------------	------------------	------------------	-----------------

3-pole with switched neutral							
0,3		C0.3T9	D0.3T9	K0.3T9		480	3
0,5		C0.5T9	D0.5T9	K0.5T9		480	3
0,8		C0.8T9	D0.8T9	K0.8T9		480	3
1	B1T9	C1T9	D1T9	K1T9		480	3
1,6		C1.6T9	D1.6T9	K1.6T9		480	3
2	B2T9	C2T9	D2T9	K2T9		480	3
2,5		C2.5T9	D2.5T9	K2.5T9		480	3
3	B3T9	C3T9	D3T9	K3T9		480	3
3,5		C3.5T9	D3.5T9	K3.5T9		480	3
4	B4T9	C4T9	D4T9	K4T9		480	3
5	B5T9	C5T9	D5T9	K5T9		480	3
6	B6T9	C6T9	D6T9	K6T9		480	3
8		C8T9	D8T9	K8T9		480	3
10	B10T9	C10T9	D10T9	K10T9		480	3
13	B13T9	C13T9	D13T9	K13T9		480	3
16	B16T9	C16T9	D16T9	K16T9		480	3
20	B20T9	C20T9	D20T9	K20T9		480	3
25	B25T9	C25T9	D25T9	K25T9		480	3
32	B32T9	C32T9	D32T9	K32T9		480	3
40	B40T9	C40T9	D40T9	K40T9		500	3
50	B50T9	C50T9	D50T9	K50T9		540	3
63	B63T9	C63T9	D63T9	K63T9		540	3



4-pole							
0,3		C0.3T4	D0.3T4	K0.3T4		480	3
0,5		C0.5T4	D0.5T4	K0.5T4		480	3
0,8		C0.8T4	D0.8T4	K0.8T4		480	3
1	B1T4	C1T4	D1T4	K1T4		480	3
1,6		C1.6T4	D1.6T4	K1.6T4		480	3
2	B2T4	C2T4	D2T4	K2T4		480	3
2,5		C2.5T4	D2.5T4	K2.5T4		480	3
3	B3T4	C3T4	D3T4	K3T4		480	3
3,5		C3.5T4	D3.5T4	K3.5T4		480	3
4	B4T4	C4T4	D4T4	K4T4		480	3
5	B5T4	C5T4	D5T4	K5T4		480	3
6	B6T4	C6T4	D6T4	K6T4		480	3
8		C8T4	D8T4	K8T4		480	3
10	B10T4	C10T4	D10T4	K10T4		480	3
13	B13T4	C13T4	D13T4	K13T4		480	3
16	B16T4	C16T4	D16T4	K16T4		480	3
20	B20T4	C20T4	D20T4	K20T4		480	3
25	B25T4	C25T4	D25T4	K25T4		480	3
32	B32T4	C32T4	D32T4	K32T4		480	3
40	B40T4	C40T4	D40T4	K40T4		500	3
50	B50T4	C50T4	D50T4	K50T4		540	3
63	B63T4	C63T4	D63T4	K63T4		540	3

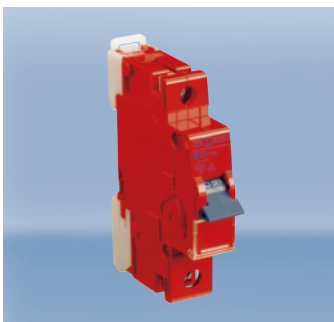

B miniature circuit breakers 10 A for the special designation of circuits e.g. EDP, fire warning, cash desk and telephone systems							
10	B10T1R					150	12



Shunt trip

Module	Rated operating voltage	max. operating current at U_n ($t < 10\text{ms}$)	Article no.	Weight g/each	Packing unit
1	12 V UC	1,3 A	FL12	105	5
1	24 V UC	0,6 A	FL24	105	5
1	48 - 72 V UC	0,2 A	FL48	105	5
1	110-230 V UC, 400 V AC	0,25 A at 110 V 0,5 A at 230 V 0,8 A at 400 V	FL110	105	5

Pull-in voltage $0.7 \times U_e$ Switch in duration at U_e 100%



Undervoltage trip (50/60 Hz)

Module	Rated voltage	Article no.	Weight g/each	Packing unit
1	24 V 50/60 Hz	UL24	150	5
1	110 V 50 Hz, 120 V 60 Hz	UL110	150	5
1	220-230 V 50 Hz, 240 V 60 Hz	UL230	150	5
1	380-400 V 50 Hz, 440 V 60 Hz	UL400	150	5

Pull-in voltage $0.85 \times U_e$ Drop-out voltage $0,35 - 0,7 \times U_e$ Switch in duration at U_e 100%

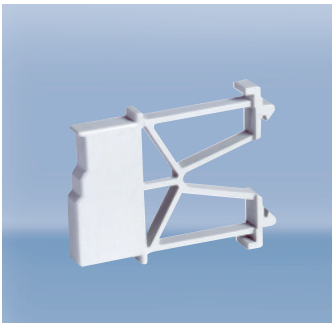

Distance device 9 mm

Module	Article no.	Weight g/each	Packing unit
1/2	HDS	7	10



Lock-off/Lock-on device

Article no.	Weight g/each	Packing unit
EASS	2	10



Auxiliary contact

Module	Type of contact	Contacts	Article no.	Weight g/each	Packing unit
$\frac{1}{2}$	1 auxiliary contact	1NO	HL10	35	20
$\frac{1}{2}$	2 auxiliary contacts	1NO + 1NC	HL11	40	20
$\frac{1}{2}$	3 auxiliary contacts	1NO + 2NC	HL12	45	20
$\frac{1}{2}$	3 auxiliary contacts	2NO + 1NC	HL21	45	20

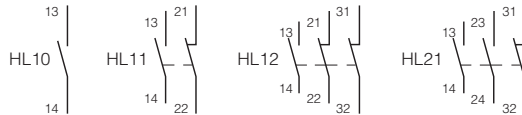

Auxiliary contact

Module	Type of contact	Contacts	Article no.	Weight g/each	Packing unit
$\frac{1}{2}$	1 auxiliary contact	1 change-over	HWL10	40	20
$\frac{1}{2}$	2 auxiliary contacts	2 change-over	HWL20	50	20

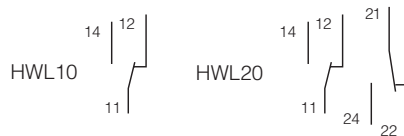

Auxiliary contact with signal contact

Module	Type of contact	Contacts	Article no.	Weight g/each	Packing unit
$\frac{1}{2}$	1 signal contact / 1 auxiliary contact	2 change-over	HSL11	50	20
$\frac{1}{2}$	1 signal contact	1 change-over	HSL10	40	20

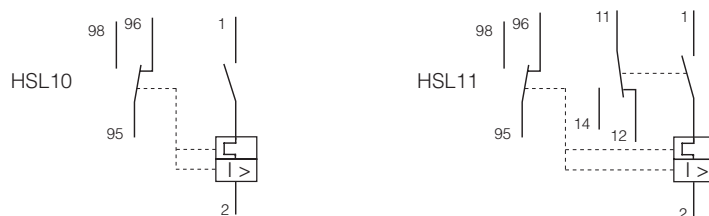

The signal contact and the auxiliary contact are each fitted with a floating change-over contact.

Both contacts have trip-free mechanisms, i.e. manipulating the contact positions from outside is not possible. The signal contact only indicates when the main device is overloaded or short circuited but not when switched off by hand. The auxiliary contact clearly shows the switched condition of the main device i.e. when overloaded or short circuited and when switched off manually.

Technical Data		HL10, HL11, HL12, HL21	HWL10, HWL20, HSL10, HSL11
Standards		IEC 60947-5-1, DIN EN 60947-5-1, VDE 0660-200	
Rated voltage		230 V~	
Conventional thermal current in enclosure		$I_{th} e 16 A$	
Rated operating currents I_e	Usage category AC-15	10 A / 230 V	4,8 A / 230 V
	Usage category AC-15	16 A / 110 V	9,6 A / 120 V
	Usage category DC-13	1 A / 250 V	1,8 A / 250 V
	Usage category DC-13	3 A / 125 V	2 A / 125 V
Minimum switching capacity		0,05 VA bei 6 V UC	

Busbars

Busbars for S, SL and T miniature circuit breakers, MA motor circuit breakers and residual current circuit breakers

Cross section (mm ²)	Busbar current Start of busbar/ Middle infeed	Modules/ Phases	Article no.	Weight g/each	Packing unit	Suitable end cap Article no.
----------------------------------	---	--------------------	-------------	------------------	-----------------	------------------------------------

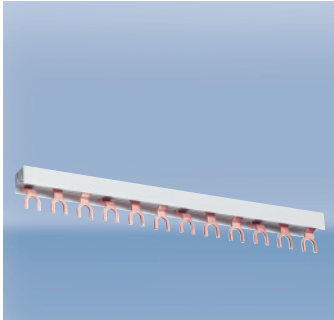

Busbars fork type

1-phase						
12	65/110	56	SB16010	250	50	
1-phase 1-pole circuit breaker + auxiliary contact						
24	90/150	37/1	SDO.124	200	50	
2-phase and 1-phase + N						
10	63/100	28/2	SB26010	390	20	SB.A5
2-phase 2-pole circuit breaker + auxiliary contact						
16	80/130	22/2	SB26216	310	20	SB.A2
3-phase						
10	63/100	4/3	SB31210	84	25	SB.A1
10	63/100	19/3	SB36010	420	20	SB.A1
16	80/130	19/3	SB36016	675	20	SB.A2
3-phase 3-pole circuit breaker + auxiliary contact						
16	80/130	16/3	SB36316	630	20	SB.A2
3-phase 1-pole circuit breaker + auxiliary contact						
16	80/130	36/1	SDO.316	500	20	SB.A2
4-phase and 3-phase + N						
16	80/130	14/4	SB46016	835	15	SB.A3



End caps for busbars

for busbars article no.	Article no.	Weight g/each	Packing unit
SB31210, SB36010	SB.A1	0,8	10
SB36016, SB36316, SDO.316, SB718U, SB26216	SB.A2	1	10
SB46016	SB.A3	1,1	10
SB26010	SB.A5	0,8	10

Technical Data **Page 33**

B, C, D, E, G and Z Characteristic

- 1-pole, 1-pole with switched neutral **Page 37**
- 2-pole, 3-pole **Page 38**
- 3-pole with switched neutral **Page 39**

Accessories

- Auxiliary contact **Page 40**
- Shunt trip **Page 40**
- Busbars **Page 41**

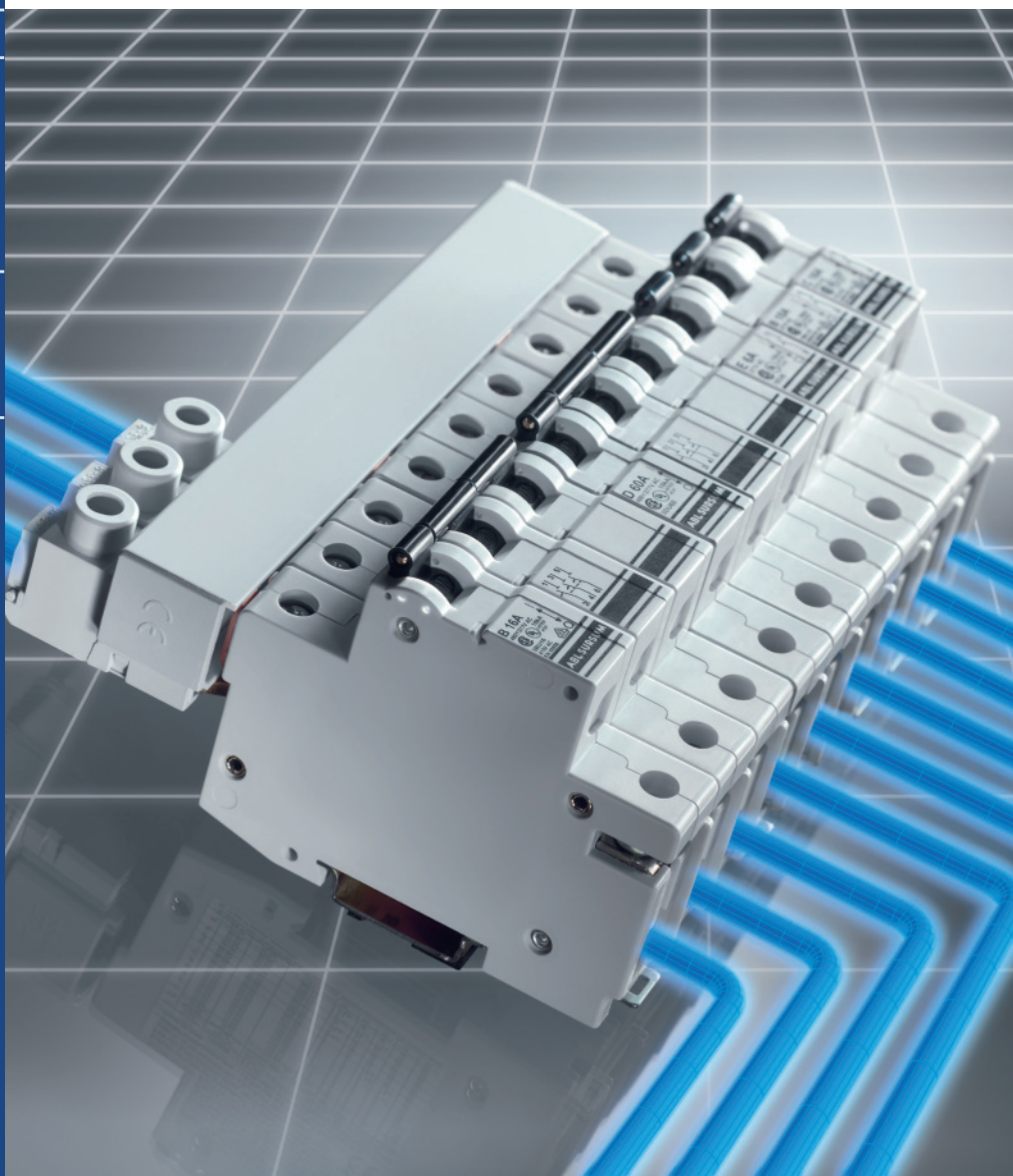

Miniature Circuit Breakers (MCBs) Manual Motor Controller according to UL 508 and CSA-22.2 No.14





Power feed terminals
6 to 35 mm²

Busbars
18 and 25 mm²

Protection cover
for busbars

UL-approved accessories

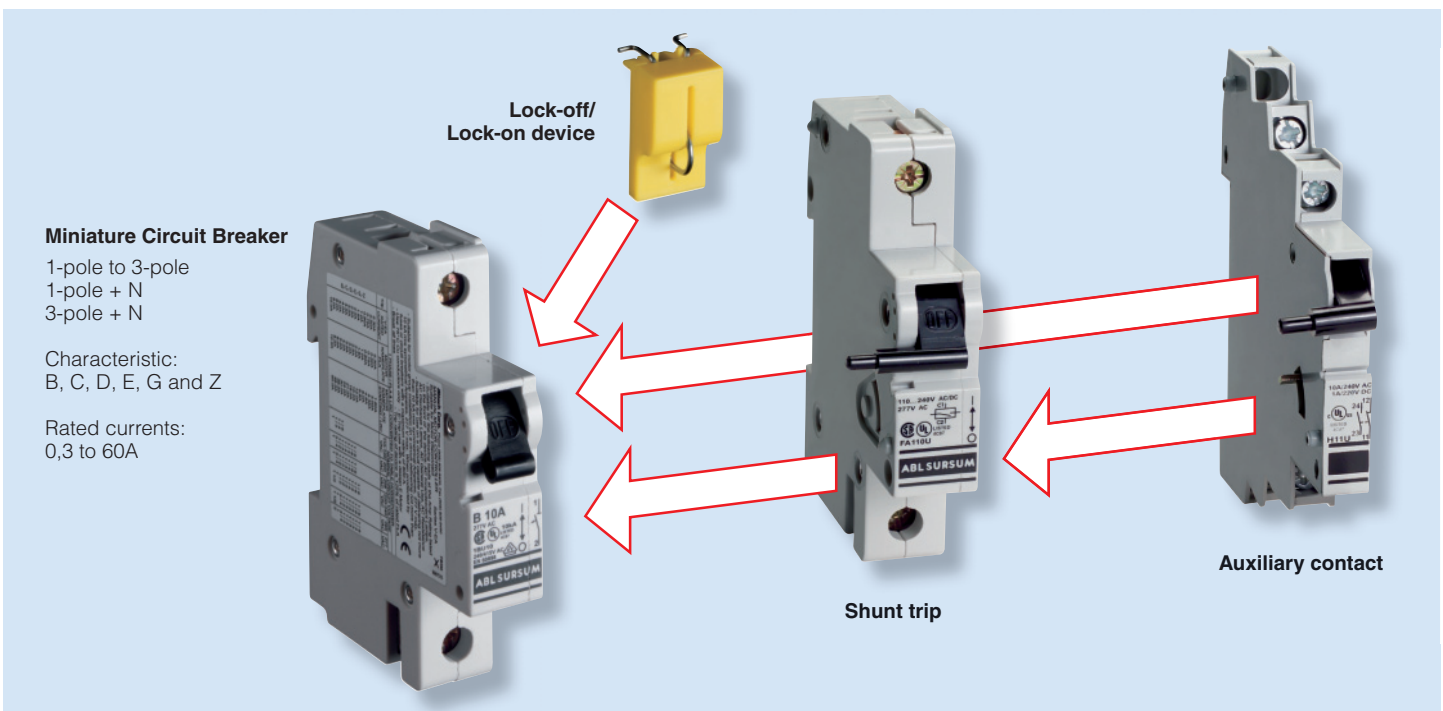

Miniature Circuit Breaker

1-pole to 3-pole
1-pole + N
3-pole + N

Characteristic:
B, C, D, E, G and Z

Rated currents:
0,3 to 60A

Lock-off/
Lock-on device

Shunt trip

Auxiliary contact

Characteristic		B	C	D	E	G	Z	
Application		Wiring protection	Wiring protection Device protection	Wiring protection Power circuits Transformers Motors	Wiring protection Power circuits Transformers Motors	Wiring protection Device protection	Wiring protection Semiconductor protection High impedance	
Number of poles		1 - 3; 1 + N; 3 + N						
Standards		IEC 60898-1, DIN EN 60898-1, VDE 0641-11, UL 508, CSA-22.2 No.14						
Short circuit withstand rating		see data sheet for use in the USA, Canada and Europe						
Current limiting class		3	3					
Max. back-up fuse		see data sheet for use in the USA, Canada and Europe						
Rated AC voltage		277 / 480 V						
Rated DC voltage L/R = 4 ms		1-pole 42 V and 2-poles 80 V in serial connection of both poles (up to 25 A rated current)						
		1-pole 24 V and 2-poles 60 V in serial connection of both poles (30 A - 60 A rated current)						
Rated current range		6 - 60 A	0,3 - 60 A	0,3 - 60 A	0,3 - 60 A	0,3 - 60 A	0,3 - 32 A	
Test currents	Thermal not tripping $I_1 (A) > 1 \text{ h}$	$1,13 \times I_n$	$1,13 \times I_n$	$1,13 \times I_n$	$1,05 \times I_n$	$1,05 \times I_n$	$1,05 \times I_n$	
	Thermal tripping $I_2 (A) < 1 \text{ h}$	$1,45 \times I_n$	$1,45 \times I_n$	$1,45 \times I_n$	$1,35 \times I_n$	$1,35 \times I_n$	$1,35 \times I_n$	
	Electromagnetic not tripping $I_3 (A) > 0,1 \text{ s}$	$3 \times I_n$	$5 \times I_n$	$10 \times I_n$	$14 \times I_n$	$8 \times I_n$	$2 \times I_n$	
	Electromagnetic tripping $I_4 (A) < 0,1 \text{ s}$	$5 \times I_n$	$10 \times I_n$	$16 \times I_n$	$18 \times I_n$	$10 \times I_n$	$3 \times I_n$	
Reference calibration temperature of the thermal tripping		30° C + 5° C			20° C + 5° C			
		Influence of the ambient temperature on the thermal release: Decrease of the current values with higher ambient temperature and increase with lower temperatures of approximately 5% per 10°C difference in temperature						
Frequency range of the electromagnetic trip		16 2/3 to 60 Hz With higher frequencies, the electromagnetic tripping values increase by approximately a factor of 1.1 at 100 Hz; 1.2 at 200 Hz; 1.3 at 300 Hz; 1.4 at 400 Hz; 1.5 for DC						
Ambient temperature		-25° C to +55° C						
Storage temperature		-40° C to +70° C						
Device depth according to DIN 43880		68 mm						
Mechanical endurance		20.000 switching cycles (20.000 ON / 20.000 OFF)						
Protection cover		Finger safe and safe to back of hand according to DIN EN 50274/ VDE0660-514, BGV A2						
Insulation group according to DIN/ VDE 0110		C at 250 V AC B at 400 V AC						
Degree of protection according to EN / IEC 60529		IP 20						
Installation position		any						
Mounting		DIN-rail according to DIN EN 60715 35 mm						
Lockability		The handle can be secured against manual switching in the on and off position by a lead seal						
Climatic resistance		Humid heat constant according to DIN EN 60068-2-78 Humid heat cycle according to DIN EN 60068-2-30						
Vibration resistance		> 15 g according to DIN EN 60068-2-59 during a load with I_1						
Resistance to mechanical shocks		25g 11ms						

Type of conductor	Conductor cross sections			
	Box terminal bottom		Box terminal top	
	max.	min.	max.	min.
Single wire	35 mm ²	0,5 mm ²	25 mm ²	0,5 mm ²
Multiple wire	35 mm ²	(16 mm ²)	25 mm ²	(16 mm ²)
Stranded wire	25 mm ²	0,5 mm ²	16 mm ²	0,5 mm ²
Stranded wire with ferrule	16 mm ²	0,5 mm ²	16 mm ²	0,5 mm ²
Busbar cable lug	Up to 3 mm thickness		Up to 1,5 mm thickness	
Combined, connector and busbar or cable lug	Up to 35 mm ² and up to 2 mm thickness		Not possible	
Torque	max. 2 Nm			

Short circuit withstand rating and maximum back-up fuse for use in the USA and Canada

Characteristic	B; C; D; E; G and Z				
	UL 508 and CSA-22.2 No.14				
Standards	Number of poles	Maximum rated voltage V	Rated current A	Short circuit withstand rating kA	Maximum back-up fuse
Short circuit withstand rating at rated voltage Ambient temperature 40° C	1 / 1 + N	277	0,3 - 10	10	70 A
	1 / 1 + N	277	12 - 60	10	4 x I _n
	2 / 3 / 3 + N	480	0,3 - 10	10	70 A
	2 / 3 / 3 + N	480	12 - 60	10	4 x I _n
Back-up fuse for group installations	1 / 1 + N	277	0,3 - 10	10	800 A
	1 / 1 + N	277	12 - 60	5	800 A
	2 / 3 / 3 + N	480	0,3 - 10	10	800 A
	2 / 3 / 3 + N	480	12 - 60	5	800 A

Short circuit withstand rating and maximum back-up fuse for use in Europe

Characteristic	B; C; D; E; G and Z				
	IEC 60947-2, DIN EN 60947-2, VDE 0660-101, UL 508 and CSA-22.2 No.14 B, C and D characteristic acc. to IEC 60898-1, DIN EN 60898-1, VDE 0641-11				
Standards	Number of poles	Maximum rated voltage V	Rated current A	Short circuit withstand rating kA	Maximum back-up fuse A
Short circuit withstand rating at rated voltage	1 / 2 / 1 + N	277	0,3 - 60	10	160
	2 / 3 / 3 + N	480	0,3 - 60	10	160

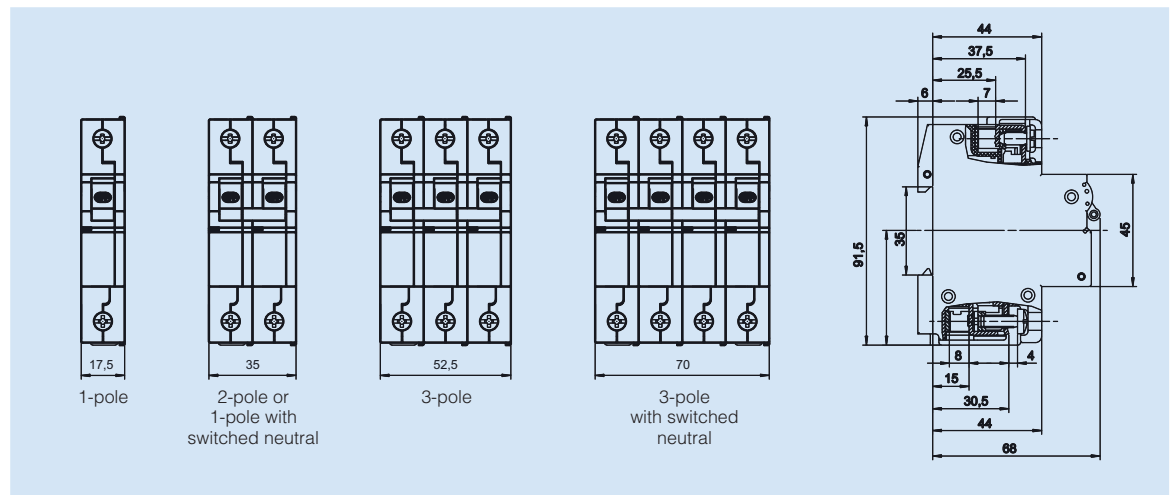

Miniature Circuit Breakers Manual Motor Controller

according to UL 508 and CSA-22.2 No.14
Characteristic

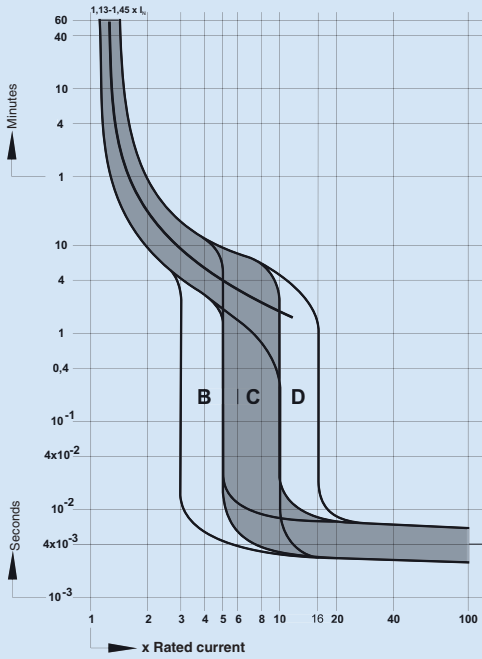

B, C and D characteristic $I_n = 0,3 - 10 \text{ A}$
UL

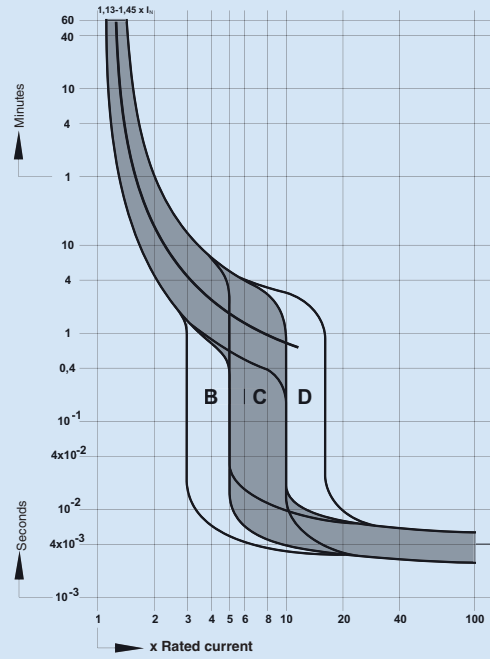

B, C and D characteristic $I_n = 13 - 60 \text{ A}$
UL

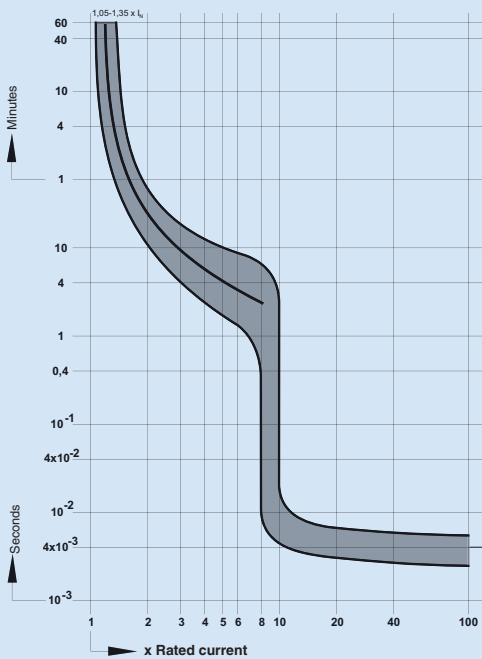

G characteristic $I_n = 0,3 - 10 \text{ A}$
UL

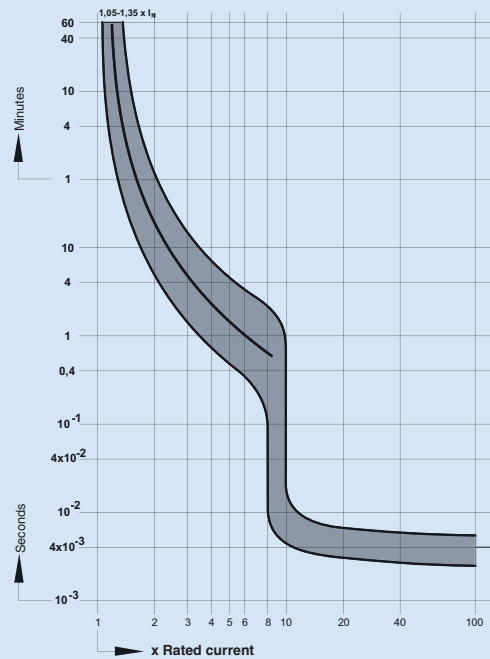

G characteristic $I_n = 12 - 60 \text{ A}$
UL

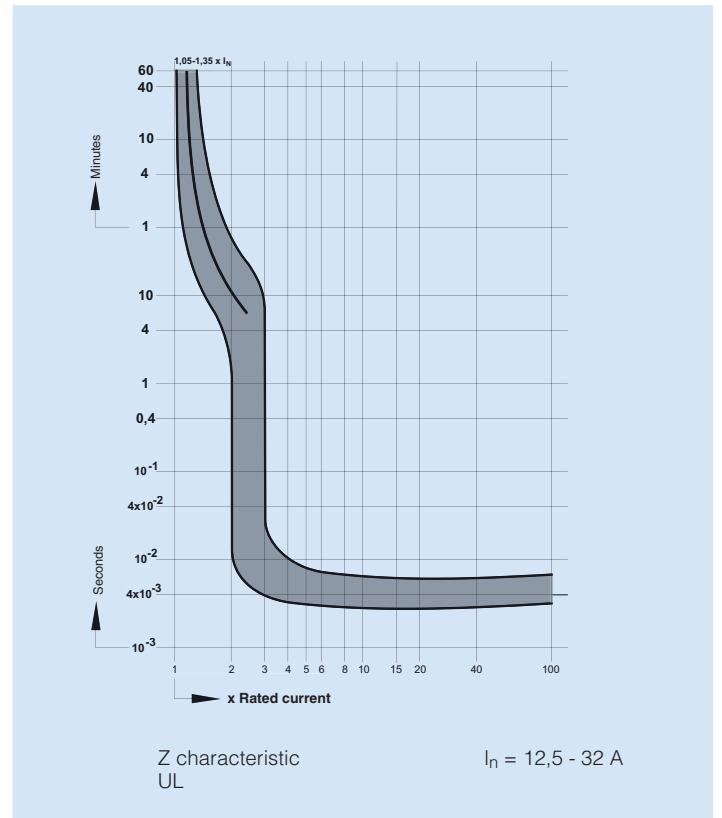
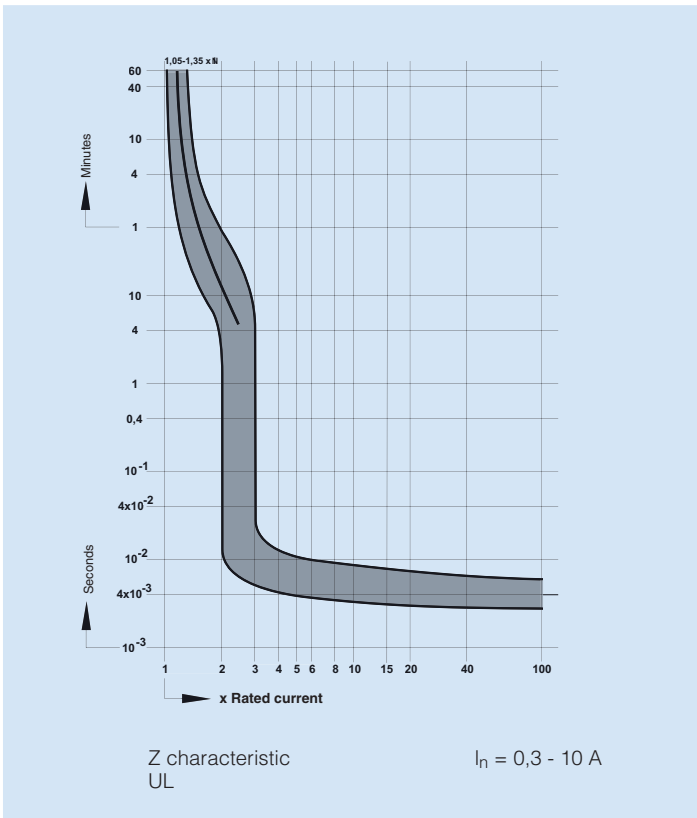
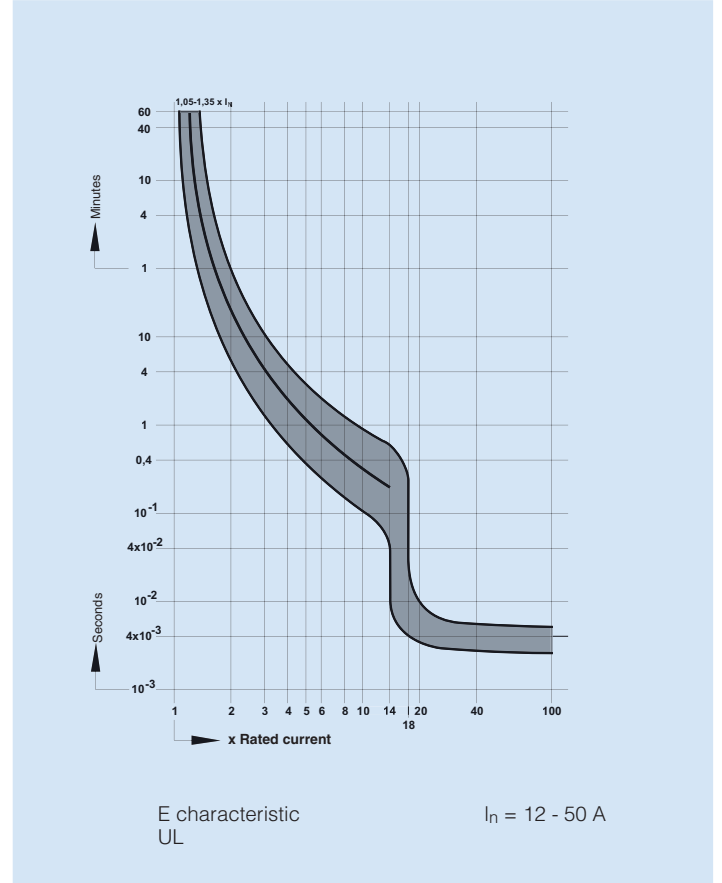
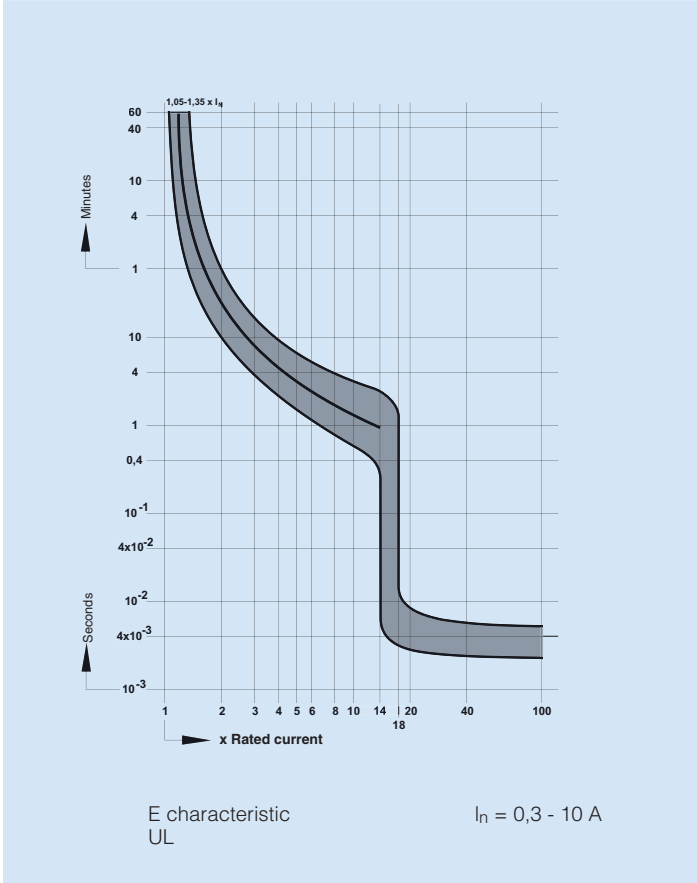

according to UL 508 and CSA-22.2 No.14

B, C and D also acc. to IEC 60898-1, DIN EN 60898-1, VDE 0641-11

This product range differentiates between:

- standard products for normal market applications (**shown in the table in bold**)
- exclusive products for branch-specific applications (shown in the table in normal print)



Rated current I _n A	Characteristic						Weight g/each	Packing unit
	B Article no.	C Article no.	D Article no.	G Article no.	E Article no.	Z Article no.		

1-pole								
0,3		1CU03	1DU03	1GU03	1EU03	1ZU03	150	12
0,5		1CU05	1DU05	1GU05	1EU05	1ZU05	150	12
0,75		1CU075	1DU075	1GU075	1EU075	1ZU075	150	12
1		1CU1	1DU1	1GU1	1EU1	1ZU1	150	12
1,6		1CU1.6	1DU1.6	1GU1.6	1EU1.6	1ZU1.6	150	12
2		1CU2	1DU2	1GU2	1EU2	1ZU2	150	12
2,5		1CU2.5	1DU2.5	1GU2.5	1EU2.5	1ZU2.5	150	12
3		1CU3	1DU3	1GU3	1EU3	1ZU3	150	12
3,5		1CU3.5	1DU3.5	1GU3.5	1EU3.5	1ZU3.5	150	12
4		1CU4	1DU4	1GU4	1EU4	1ZU4	150	12
5			1CU5	1DU5	1GU5	1EU5	150	12
6	1BU6	1CU6	1DU6	1GU6	1EU6	1ZU6	150	12
8		1CU8	1DU8	1GU8	1EU8	1ZU8	150	12
10	1BU10	1CU10	1DU10	1GU10	1EU10	1ZU10	150	12
13	1BU13	1CU13	1DU13	1GU13	1EU13	1ZU13	150	12
15	1BU15	1CU15	1DU15	1GU15	1EU15	1ZU15	150	12
16	1BU16	1CU16	1DU16	1GU16	1EU16	1ZU16	150	12
20	1BU20	1CU20	1DU20	1GU20	1EU20	1ZU20	150	12
25	1BU25	1CU25	1DU25	1GU25	1EU25	1ZU25	150	12
32	1BU32	1CU32	1DU32	1GU32	1EU32	1ZU32	150	12
40	1BU40	1CU40	1DU40	1GU40	1EU40		150	12
50	1BU50	1CU50	1DU50	1GU50	1EU50		150	12
60	1BU60	1CU60	1DU60	1GU60	1EU60		150	12



1-pole with switched neutral								
0,3		2CNU03	2DNU03	2GNU03	2ENU03	2ZNU03	300	6
0,5		2CNU05	2DNU05	2GNU05	2ENU05	2ZNU05	300	6
0,75		2CNU075	2DNU075	2GNU075	2ENU075	2ZNU075	300	6
1		2CNU1	2DNU1	2GNU1	2ENU1	2ZNU1	300	6
1,6		2CNU1.6	2DNU1.6	2GNU1.6	2ENU1.6	2ZNU1.6	300	6
2		2CNU2	2DNU2	2GNU2	2ENU2	2ZNU2	300	6
2,5		2CNU2.5	2DNU2.5	2GNU2.5	2ENU2.5	2ZNU2.5	300	6
3		2CNU3	2DNU3	2GNU3	2ENU3	2ZNU3	300	6
3,5		2CNU3.5	2DNU3.5	2GNU3.5	2ENU3.5	2ZNU3.5	300	6
4		2CNU4	2DNU4	2GNU4	2ENU4	2ZNU4	300	6
5		2CNU5	2DNU5	2GNU5	2ENU5	2ZNU5	300	6
6	2BNU6	2CNU6	2DNU6	2GNU6	2ENU6	2ZNU6	300	6
8		2CNU8	2DNU8	2GNU8	2ENU8	2ZNU8	300	6
10	2BNU10	2CNU10	2DNU10	2GNU10	2ENU10	2ZNU10	300	6
13	2BNU13	2CNU13	2DNU13	2GNU13	2ENU13	2ZNU13	300	6
15	2BNU15	2CNU15	2DNU15	2GNU15	2ENU15	2ZNU15	300	6
16	2BNU16	2CNU16	2DNU16	2GNU16	2ENU16	2ZNU16	300	6
20	2BNU20	2CNU20	2DNU20	2GNU20	2ENU20	2ZNU20	300	6
25	2BNU25	2CNU25	2DNU25	2GNU25	2ENU25	2ZNU25	300	6
32	2BNU32	2CNU32	2DNU32	2GNU32	2ENU32	2ZNU32	300	6
40	2BNU40	2CNU40	2DNU40	2GNU40	2ENU40		300	6
50	2BNU50	2CNU50	2DNU50	2GNU50	2ENU50		300	6
60	2BNU60	2CNU60	2DNU60	2GNU60	2ENU60		300	6

according to UL 508 and CSA-22.2 No.14
B, C and D also acc. to IEC 60898-1, DIN EN 60898-1, VDE 0641-11

This product range differentiates between:

- standard products for normal market applications (**shown in the table in bold**)
- exclusive products for branch-specific applications (shown in the table in normal print)



Rated current I _n A	Characteristic						Weight g/each	Packing unit
	B	C	D	G	E	Z		
	Article no.	Article no.	Article no.	Article no.	Article no.	Article no.		

2-pole								
0,3		2CU03	2DU03	2GU03	2EU03	2ZU03	300	6
0,5		2CU05	2DU05	2GU05	2EU05	2ZU05	300	6
0,75		2CU075	2DU075	2GU075	2EU075	2ZU075	300	6
1		2CU1	2DU1	2GU1	2EU1	2ZU1	300	6
1,6		2CU1.6	2DU1.6	2GU1.6	2EU1.6	2ZU1.6	300	6
2		2CU2	2DU2	2GU2	2EU2	2ZU2	300	6
2,5		2CU2.5	2DU2.5	2GU2.5	2EU2.5	2ZU2.5	300	6
3		2CU3	2DU3	2GU3	2EU3	2ZU3	300	6
3,5		2CU3.5	2DU3.5	2GU3.5	2EU3.5	2ZU3.5	300	6
4		2CU4	2DU4	2GU4	2EU4	2ZU4	300	6
5		2CU5	2DU5	2GU5	2EU5	2ZU5	300	6
6	2BU6	2CU6	2DU6	2GU6	2EU6	2ZU6	300	6
8		2CU8	2DU8	2GU8	2EU8	2ZU8	300	6
10	2BU10	2CU10	2DU10	2GU10	2EU10	2ZU10	300	6
13	2BU13	2CU13	2DU13	2GU13	2EU13	2ZU13	300	6
15	2BU15	2CU15	2DU15	2GU15	2EU15	2ZU15	300	6
16	2BU16	2CU16	2DU16	2GU16	2EU16	2ZU16	300	6
20	2BU20	2CU20	2DU20	2GU20	2EU20	2ZU20	300	6
25	2BU25	2CU25	2DU25	2GU25	2EU25	2ZU25	300	6
32	2BU32	2CU32	2DU32	2GU32	2EU32	2ZU32	300	6
40	2BU40	2CU40	2DU40	2GU40	2EU40		300	6
50	2BU50	2CU50	2DU50	2GU50	2EU50		300	6
60	2BU60	2CU60	2DU60	2GU60	2EU60		300	6



3-pole								
0,3		3CU03	3DU03	3GU03	3EU03	3ZU03	450	4
0,5		3CU05	3DU05	3GU05	3EU05	3ZU05	450	4
0,75		3CU075	3DU075	3GU075	3EU075	3ZU075	450	4
1		3CU1	3DU1	3GU1	3EU1	3ZU1	450	4
1,6		3CU1.6	3DU1.6	3GU1.6	3EU1.6	3ZU1.6	450	4
2		3CU2	3DU2	3GU2	3EU2	3ZU2	450	4
2,5		3CU2.5	3DU2.5	3GU2.5	3EU2.5	3ZU2.5	450	4
3		3CU3	3DU3	3GU3	3EU3	3ZU3	450	4
3,5		3CU3.5	3DU3.5	3GU3.5	3EU3.5	3ZU3.5	450	4
4		3CU4	3DU4	3GU4	3EU4	3ZU4	450	4
5		3CU5	3DU5	3GU5	3EU5	3ZU5	450	4
6	3BU6	3CU6	3DU6	3GU6	3EU6	3ZU6	450	4
8		3CU8	3DU8	3GU8	3EU8	3ZU8	450	4
10	3BU10	3CU10	3DU10	3GU10	3EU10	3ZU10	450	4
13	3BU13	3CU13	3DU13	3GU13	3EU13	3ZU13	450	4
15	3BU15	3CU15	3DU15	3GU15	3EU15	3ZU15	450	4
16	3BU16	3CU16	3DU16	3GU16	3EU16	3ZU16	450	4
20	3BU20	3CU20	3DU20	3GU20	3EU20	3ZU20	450	4
25	3BU25	3CU25	3DU25	3GU25	3EU25	3ZU25	450	4
32	3BU32	3CU32	3DU32	3GU32	3EU32	3ZU32	450	4
40	3BU40	3CU40	3DU40	3GU40	3EU40		450	4
50	3BU50	3CU50	3DU50	3GU50	3EU50		450	4
60	3BU60	3CU60	3DU60	3GU60	3EU60		450	4

Miniature Circuit Breakers Manual Motor Controller

according to UL 508 and CSA-22.2 No.14

B, C and D also acc. to IEC 60898-1, DIN EN 60898-1, VDE 0641-11

This product range differentiates between:

- standard products for normal market applications (**shown in the table in bold**)
- exclusive products for branch-specific applications (shown in the table in normal print)



Rated current I _n A	Characteristic						Weight g/each	Packing unit
	B Article no.	C Article no.	D Article no.	G Article no.	E Article no.	Z Article no.		

3-pole with switched neutral

0,3		4CNU03	4DNU03	4GNU03	4ENU03	4ZNU03	600	3
0,5		4CNU05	4DNU05	4GNU05	4ENU05	4ZNU05	600	3
0,75		4CNU075	4DNU075	4GNU075	4ENU075	4ZNU075	600	3
1		4CNU1	4DNU1	4GNU1	4ENU1	4ZNU1	600	3
1,6		4CNU1.6	4DNU1.6	4GNU1.6	4ENU1.6	4ZNU1.6	600	3
2		4CNU2	4DNU2	4GNU2	4ENU2	4ZNU2	600	3
2,5		4CNU2.5	4DNU2.5	4GNU2.5	4ENU2.5	4ZNU2.5	600	3
3		4CNU3	4DNU3	4GNU3	4ENU3	4ZNU3	600	3
3,5		4CNU3.5	4DNU3.5	4GNU3.5	4ENU3.5	4ZNU3.5	600	3
4		4CNU4	4DNU4	4GNU4	4ENU4	4ZNU4	600	3
5		4CNU5	4DNU5	4GNU5	4ENU5	4ZNU5	600	3
6	4BNU6	4CNU6	4DNU6	4GNU6	4ENU6	4ZNU6	600	3
8		4CNU8	4DNU8	4GNU8	4ENU8	4ZNU8	600	3
10	4BNU10	4CNU10	4DNU10	4GNU10	4ENU10	4ZNU10	600	3
13	4BNU13	4CNU13	4DNU13	4GNU13	4ENU13	4ZNU13	600	3
15	4BNU15	4CNU15	4DNU15	4GNU15	4ENU15	4ZNU15	600	3
16	4BNU16	4CNU16	4DNU16	4GNU16	4ENU16	4ZNU16	600	3
20	4BNU20	4CNU20	4DNU20	4GNU20	4ENU20	4ZNU20	600	3
25	4BNU25	4CNU25	4DNU25	4GNU25	4ENU25	4ZNU25	600	3
32	4BNU32	4CNU32	4DNU32	4GNU32	4ENU32	4ZNU32	600	3
40	4BNU40	4CNU40	4DNU40	4GNU40	4ENU40		600	3
50	4BNU50	4CNU50	4DNU50	4GNU50	4ENU50		600	3
60	4BNU60	4CNU60	4DNU60	4GNU60	4ENU60		600	3



Auxiliary contact

Module	Type of contact	Contacts	Article no.	Weight g/each	Packing unit
1/2	1 auxiliary contact	1NO	H10U	35	10
1/2	2 auxiliary contacts	1NO + 1NC	H11U	40	10
1/2	3 auxiliary contacts	1NO + 2NC	H12U	45	10
1/2	3 auxiliary contacts	2NO + 1NC	H21U	45	10



Standards	Acc. to IEC 60947-5-1, DIN EN 60947-5-1, VDE 0660-200, UL 508	
Rated operating currents	10 A / 240 V AC 3 A / 110 V DC 1 A / 220 V DC	
Minimum contact load	1mA at 24 V DC	
Conductor cross sections		
Type of conductor	min.	max.
Single wire	0,5 mm ²	2,5 mm ²
Stranded wire	0,5 mm ²	1,5 mm ²
Stranded wire with ferrule	0,5 mm ²	1,5 mm ²
Torque	max. 0,7 Nm	



Shunt trip

Module	Rated operating voltage	max. operating current at U _n (t < 10 ms)	Article no.	Weight g/each	Packing unit
1	12 V UC	1,3 A	FA12U	105	5
1	24 V UC	0,6 A	FA24U	105	5
1	48 - 74 V UC	0,2 A	FA48U	105	5
1	110 - 240 V UC, 415 V AC	0,25A at 110 V	FA110U	105	5
		0,5 A at 240 V			
		0,8 A at 415 V			



Lock-off/Lock-on device

Article no.	Weight g/each	Packing unit
EASS	2	10

Cross section (mm ²)	Busbar current Start of busbar/ Middle infeed	Modules/ Phases	Article no.	Weight g/each	Packing unit	Suitable end cap Article no.
----------------------------------	---	--------------------	-------------	------------------	-----------------	------------------------------------

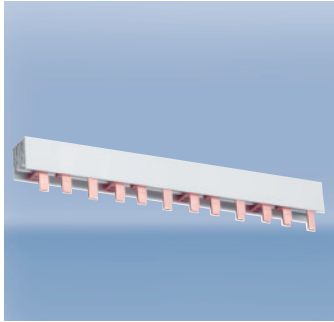

Busbars pin type acc. to UL and CSA

1-phase

18	80/130	57	SB.U1	300	1	
----	--------	----	--------------	-----	---	--

1-phase 1-pole circuit breaker + auxiliary contact

18	80/130	37/1	SB.U1H	280	1	
----	--------	------	---------------	-----	---	--

3-phase

18	80/130	19/3	SB.U3	800	1	SB.U8
----	--------	------	--------------	-----	---	-------

3-phase 3-pole circuit breaker + auxiliary contact

25	100/180	16/3	SB.U3H	1020	1	SB.U8
----	---------	------	---------------	------	---	-------

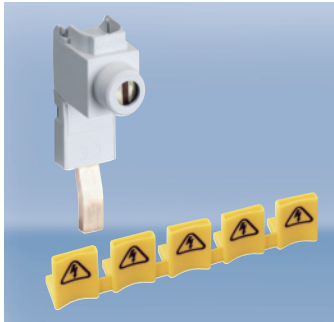

Power feed terminals

6 - 35	115		AK.U1	35	1	
--------	-----	--	--------------	----	---	--

Protection cover for busbars UL and CSA

18/25	115		SB.U9	0,6/3	1/5	
-------	-----	--	--------------	-------	-----	--

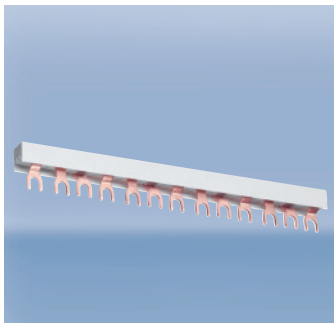

Busbars fork type without UL and CSA approval

1-phase

20	90/150	57	SB120U	410	50	
----	--------	----	---------------	-----	----	--

1-phase 1-pole circuit breaker + auxiliary contact

16	80/130	37/1	SD0124U	200	50	
----	--------	------	----------------	-----	----	--

2-phase and 1-phase + N

16	80/130	28/2	SB216U	420	20	SB.A2
----	--------	------	---------------	-----	----	-------

3-phase

16	80/130	19/3	SB316U	700	20	SB.A2
----	--------	------	---------------	-----	----	-------

3-phase 1-pole circuit breaker + auxiliary contact

16	80/130	36/1	SD0316U	530	20	SB.A2
----	--------	------	----------------	-----	----	-------

4-phase and 3-phase + N

16	80/130	14/4	SB46116	870	15	SB.A3
----	--------	------	----------------	-----	----	-------

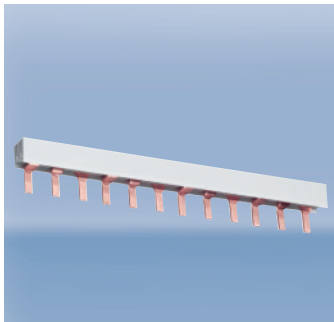

Busbars pin type without UL and CSA approval

3-phase

16	80/130	19/3	SB718U	500	20	SB.A2
----	--------	------	---------------	-----	----	-------

General Data Page 44

RCCBs, Sensitive to Pulsating Currents, Typ A

- Instantaneous tripping Page 49
- Short-time delayed tripping Page 50
- Selective tripping Page 50

RCCBs, Sensitive to Universal Current, Typ B

- Description Page 51
- Technical Data Page 52
- Short-time delayed tripping Page 53
- Selective tripping Page 53

RCBOs

- Technical Data Page 54
- with MCB
 - 1-pole + N Page 55
- with MCB 2-pole Page 55

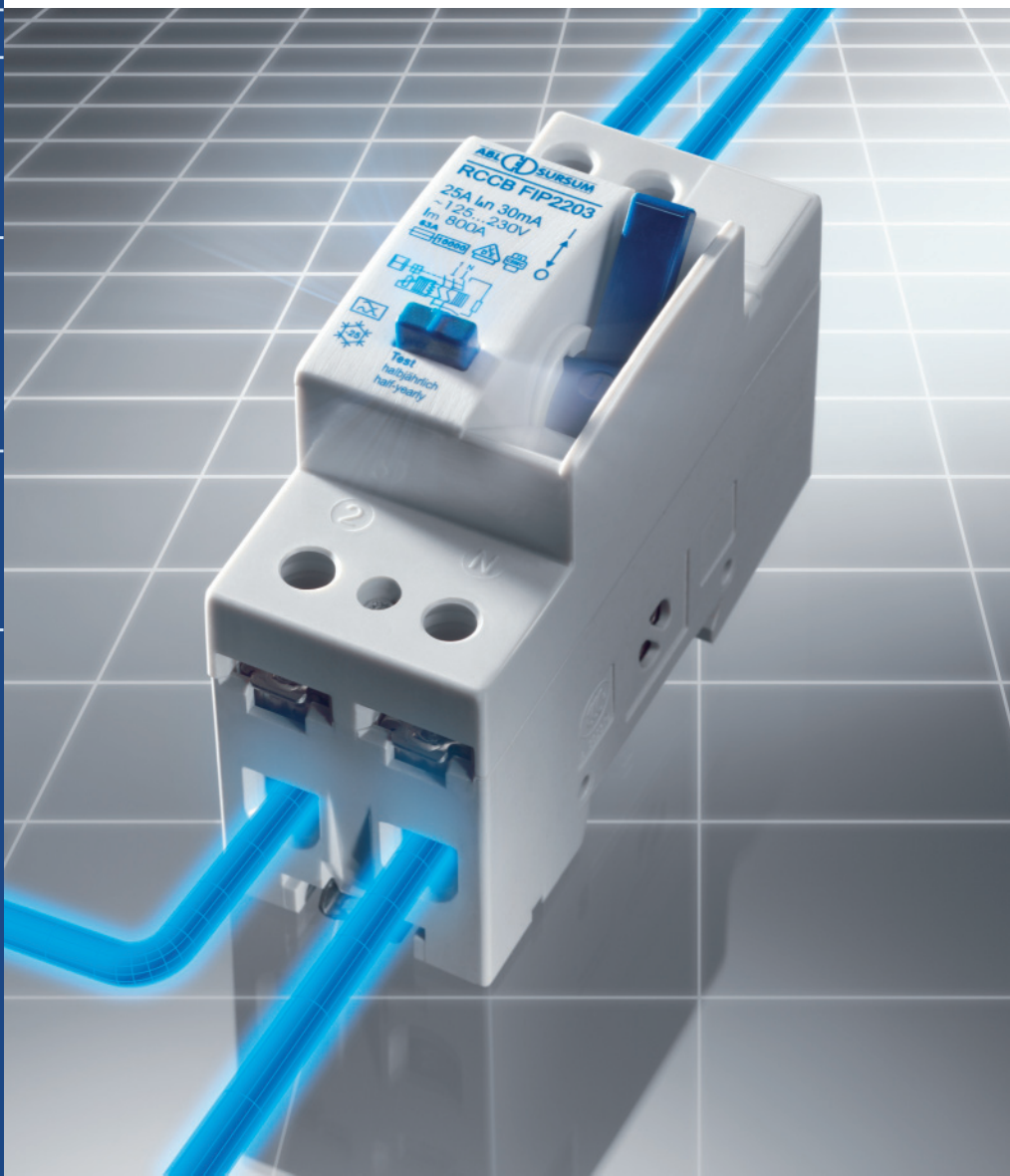

RCCBs
RCBOs



Setup and mode of operation of RCCBs

The setup of a RCCB is determined in principle by three function groups:

- 1) Summation current transformer for fault current detection
- 2) Release to convert the electrical measured value into a mechanical tripping operation
- 3) Breaker mechanism with the contacts

The summation current transformer covers all conductors required for carrying current - including the neutral, if necessary. In a fault-free system, the magnetising effects of the current-carrying conductors neutralise each other as regards the summation current transformer, as according to Kirchhoff's law, the sum of all currents is zero. No magnetic field remains which could induce a voltage in the secondary winding.

However, if a fault current flows because of an insulation fault, the equilibrium is disturbed and a magnetic field remains in the transformer core. Because of this, a voltage is created in the secondary winding which switches off the circuit with the insulation fault – via a release and the contact latching mechanism.

This release principle works independently of a supply voltage or an auxiliary power supply.

This is also the prerequisite for the high protection level, which RCCBs offer according to IEC/EN 61008 (VDE 0664). Only with this is it ensured that the full protection effect is retained also in the case of mains disruption, e.g. if an outer conductor fails or if there is an interruption in the neutral conductor.

Short-time delayed tripping

For electrical loads, which cause high temporary leakage currents when switched on (e.g. via interference suppression capacitors between outer conductor and PE drainage transient fault currents), nuisance tripping of the instantaneous RCCBs can occur when the leakage current exceeds the rated residual current $I_{\Delta n}$ of the RCCB.

For such applications where such loads or interferences cannot be removed or only partly, short-time delayed RCCBs can be used.

The devices have a minimum tripping time delay of 10ms, i.e. they must not trip with a fault current impulse of 10ms duration. Thus the maximum permissible switch off times according to IEC/EN 61008-1 (VDE 0664-10) are kept.

The devices have an increased surge current withstand rating of 3kA.

Short-time delayed RCCBs have the designation .

Test button

The operational readiness of the RCCB can be checked with a test button which every RCCB has.

On pressing the test button, an artificial fault current is created – the RCCB must release.

Checking the functional readiness by operation of the system and in regular intervals – circa twice a year – is recommended.

The checking dates in the terms or regulations (e.g. accident prevention regulations) must also be observed.

The minimum operating voltage for the test button is 100V AC.

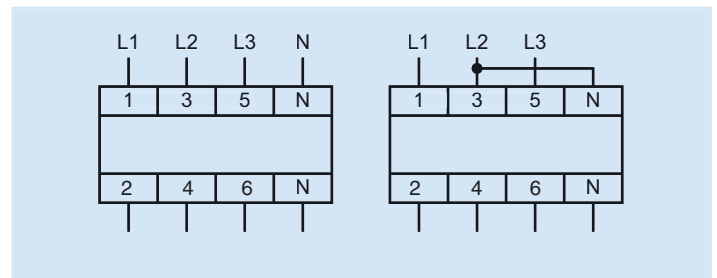

3-pole connection

4-pole RCCBs can also be used in 3-pole systems. Here the connection must be made on terminals 1, 3, 5 and 2, 4, 6.

The function of the test button is only guaranteed if a jumper is fitted in between terminals 3 and N.

Selective tripping

RCCBs normally have an undelayed tripping operation. This means that a series connection of such RCCBs with the goal of selective tripping does not work.

In order to achieve selectivity with a series connection of RCCBs, the series-connected devices must be staggered not only in the tripping time but also in the rated residual current.

Selective RCCBs have a finite tripping delay. Also, selective RCCBs must have an increased surge current strength of at least 3kA according to IEC/EN 61008-1 (VDE 0064-10).

ABL SURSUM devices have a surge current strength of ≥ 5 kA.

Selective RCCBs have the designation .

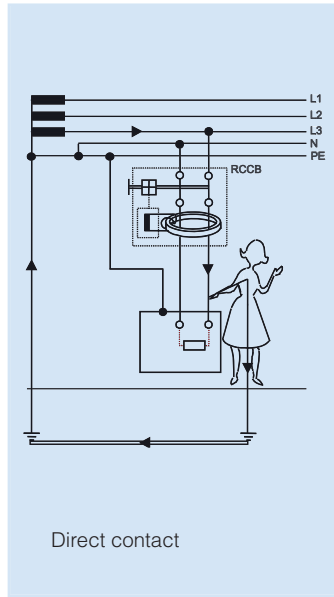
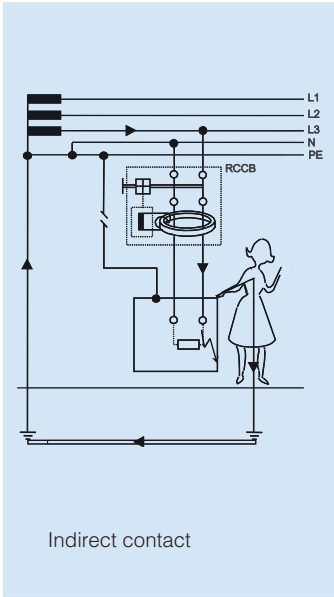

Protection against leakage currents according to DIN VDE 0100 Part 410

Application

- protection against indirect contact (indirect protection against personal injury) – as leakage protection through tripping in the event of higher touch voltages due to short-circuits to frame on equipment.
- when using RCCBs with $I_{\Delta n} \leq 30 \text{ mA}$ also a high degree of protection for direct contact (direct protection against personal injury) – as additional protection due to tripping when live parts are touched.

Protection effect

While devices for a rated residual current of $I_{\Delta n} > 30 \text{ mA}$ offer protection for indirect contact, the use of devices with $I_{\Delta n} \leq 30 \text{ mA}$ achieves an additional high degree of protection as regards accidental contact of active parts.

The permissible tripping time of max. 0.3 s (300 ms) according to VDE 0664 and/or EN 61 008 or IEC 61 008 is not used. RCCBs with rated residual currents of 10 or 30 mA often offer reliable protection if a current flows through the human body in case of accidental direct contact with live parts. This protection effect is not achieved by any other comparable means for protection in case of indirect contact.

In every case of application of the RCCB, an appropriate protective PE conductor must be attached to the equipment and units to be protected. Thus a current through the human body can only occur if there are two faults or by accidental contact of active parts.

The figure alongside shows the physiological reactions of the human body, to power flows in the effective current ranges.

The current and time values in region 4 are dangerous because they can cause ventricular fibrillation - leading to the death of the affected person. The tripping region of the RCCB with the rated residual current of 10 mA and 30 mA is also marked.

The tripping time is between 10ms and 30ms on average.

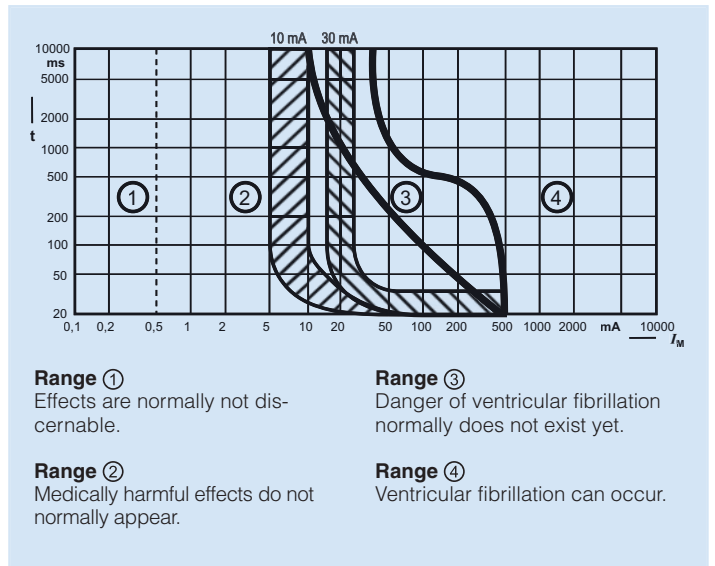

Range ①
Effects are normally not discernable.

Range ②
Medically harmful effects do not normally appear.

Range ③
Danger of ventricular fibrillation normally does not exist yet.

Range ④
Ventricular fibrillation can occur.

Protection against dangerous leakage currents according to DIN VDE 0100-410

The resistance of the human body depends on the current path. Measurements showed e.g. for a current path from hand/hand or hand/foot a resistance of about 1.000 Ω. For a fault voltage of 230 V AC, a current of 230 mA results for the current path hand/hand.

Earth resistances

When using RCCBs in a TT system, the maximum earth resistances of the table below must be kept – depending on the rated residual current and the max. permissible touch voltage.

Rated residual current	Max. permissible earth resistance at a max. permissible touch voltage of	
	50 V	25 V
I_{Δn}		
10 mA	5000 Ω	2500 Ω
30 mA	1660 Ω	830 Ω
100 mA	500 Ω	250 Ω
300 mA	166 Ω	83 Ω
500 mA	100 Ω	50 Ω

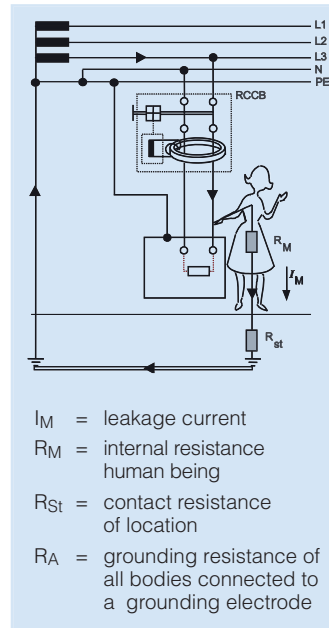

Fire protection according to DIN VDE 0100-482

When using RCCBs with $I_{\Delta n} \leq 300$ mA Protection against formation of electrically ignited fires by insulation faults.

Protection effect

For “industrial premises which are vulnerable to fire”, DIN VDE 0100-482 requires measures for the prevention of fires which can occur due to insulation faults. Electrical equipment must be selected and set up, taking into account external influences, so that their temperature rise in normal operation and the foreseeable temperature increase in case of fault cannot cause a fire. This can be achieved by a suitable construction of the equipment or by additional protection measures when setting up.

Protective devices	max. possible cont. current I _{ISO}	P _{ISO} for U _n = ~ 230 V
Fuse 10 A	15 A	3.450 W
MCB B/C/D 16 A	18 A	4.160 W
RCCB I _{Δn} = 0,5 A	0,5 A	115 W
RCCB I _{Δn} = 0,3 A	0,3 A	69 W
RCCB I _{Δn} = 30 mA	0,03 A	6,9 W

For a fire, min. power required P » 70 - 100 W



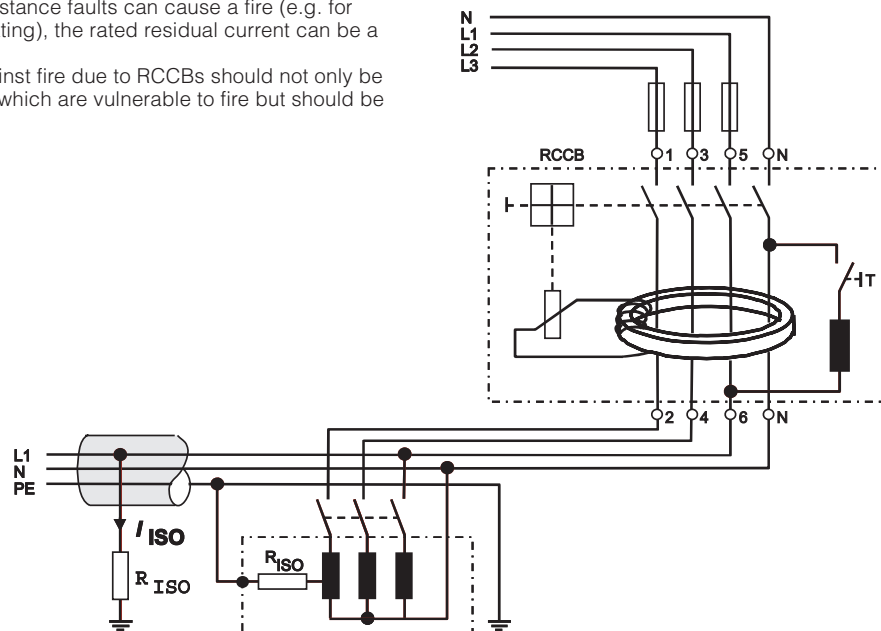

In TN and TT systems therefore, additional RCCBs with a rated residual current of max. 300 mA are required for “industrial premises which are vulnerable to fire”. Where resistance faults can cause a fire (e.g. for overhead heat with panel heating), the rated residual current can be a max. of 30 mA.

The additional protection against fire due to RCCBs should not only be limited to industrial premises which are vulnerable to fire but should be used in general.



Standards	DIN EN 61008-1 / DIN VDE 0664-10
Number of poles	2-pole, 4-pole
Short circuit withstand rating	10 kA at assignment of the corresponding back-up fuse
Max. back-up fuse	Fuse according to DIN VDE 0636 operating class gL
	for 2-pole 16 to 40 A RCCBs: 63 A
	for 4-pole 25 to 80 A RCCBs: 100 A for 4-pole 125 A RCCBs: 125 A
Rated AC voltage	2-pole 125/230 V~ 50/60 Hz, 4-pole 230/400 V~ 50/60 Hz Can be used in networks: 2-pole 120/240 V~, 4-pole 240/415 V~
Rated current I_n	16 A, 25 A, 40 A, 63 A, 80 A and 125 A
Rated residual current $I_{\Delta n}$	10 mA, 30 mA, 0,3 A, 0,5 A
Ambient temperature	-25° C to +45° C
Storage temperature	-40° C to +60° C
Electrical and mechanical endurance	10.000 switching cycles (10.000 ON/10.000 OFF)
Protection cover	Finger safe and safe to back of hand acc. to DIN EN 50274, VDE 0660-514, BGV A2
Insulation group according to DIN VDE 0110	Group 1 CTI - 600 V
Degree of protection according to IEC 60529 / EN60259	IP 20
Installation position	any
Mounting	Din rail according to DIN EN 60715 35 mm
Climatic resistance	Humid heat cycle according to DIN IEC 60068-2-30

RCCB terminals	at I_n A	Bottom terminal box		Top terminal box	
		max.	min.	max.	min.
with 2 modules	16, 25, 40	16 mm ²	1 mm ²	16 mm ²	1 mm ²
with 4 modules	25, 40, 63, 80	25 mm ²	1,5 mm ²	25 mm ²	1,5 mm ²
with 4 modules	125	50 mm ²	2,5 mm ²	50 mm ²	2,5 mm ²
Busbar	16 to 80	up to 2 mm thickness		not possible	
Conductor and busbar	16 to 80	2-pole up to 16 mm ² 4-pole up to 25 mm ²		not possible	
Busbar	125	not possible		not possible	
Conductor and busbar	125	not possible		not possible	
Add-on auxiliary contact terminals	6	0,75 mm ² to 2,5 mm ²			

Type of current	Current form	Tripping current
AC residual current		0,5 ... 1,0 $I_{\Delta n}$
Pulsating DC residual currents pos. or neg. half-waves		0,35 ... 1,4 $I_{\Delta n}$
Started half-wave currents Phase control angle $\frac{90^\circ}{135^\circ}$ el		0,25 ... 1,4 $I_{\Delta n}$ 0,11 ... 1,4 $I_{\Delta n}$
Half-wave current during superposition with smooth DC of 6 mA		max. 1,4 $I_{\Delta n}$ + 6 mA
Smooth DC		0,5 ... 2,0 $I_{\Delta n}$

**RCCB 2-pole 16 to 40 A
FIP**

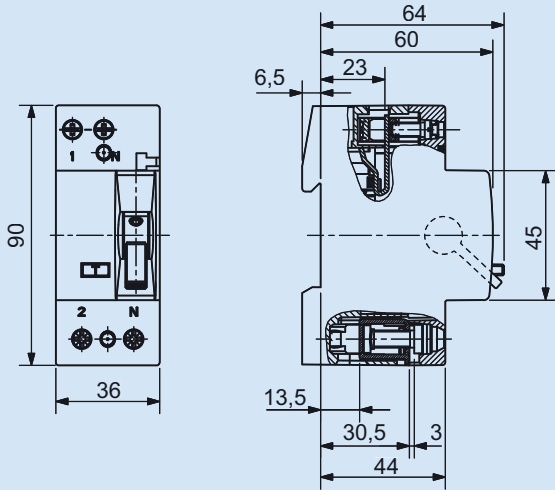

**Auxiliary contact for 2-pole and 4-pole RCCBs 16 up to 80 A,
FIH11**

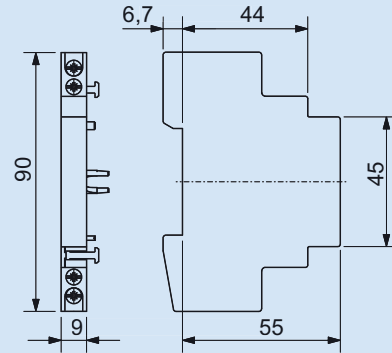

**RCCB 4-pole 25 to 80 A
FIP and FIK**

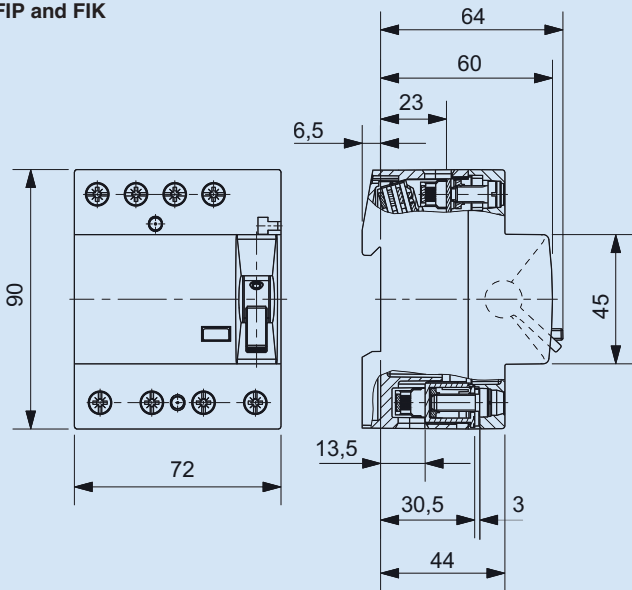

**RCCB 4-pole 25 to 80 A
FI...A and FI...S**

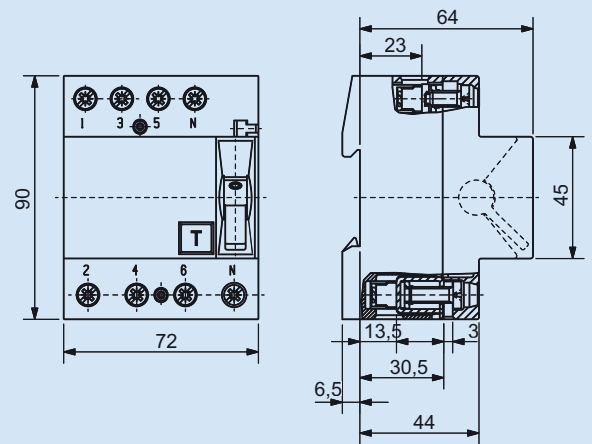

**RCCB 4-pole 125 A
FIP47 and FIS47**

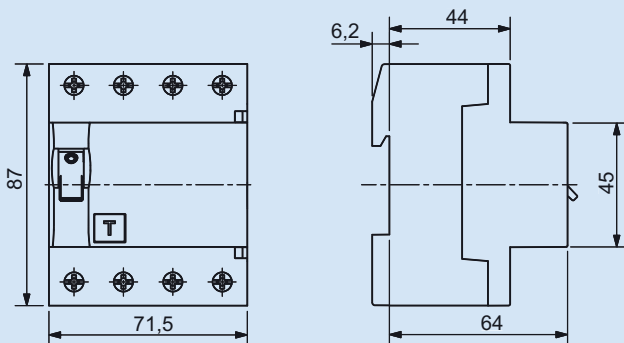

Auxiliary contact FIH125 for 4-pole RCCBs 125A

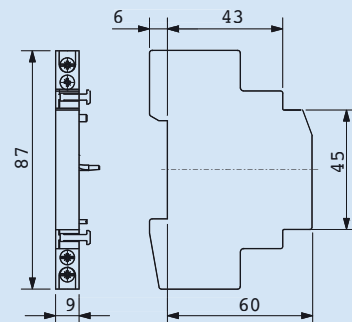

RCCBs, sensitive to pulsating currents, Typ A

Instantaneous tripping

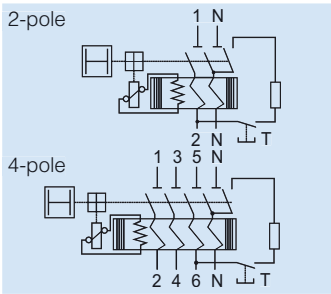

RCCBs with instantaneous trip $I_{\Delta n} \leq 30$ mA provide protection against personal injury in case of indirect and direct contact.
 RCCBs with instantaneous trip $I_{\Delta n} \leq 300$ mA offer fire protection prevention measures for earth residual currents.
 Device regulations according to IEC/EN 61008-1 (VDE 0664-10) IEC 61008-2-1 (VDE 0664-11) IEC EN 61 543 (VDE 0664-30)
 Current strength with current form 8/20 μ s according to DIN VDE 0432-2
 U_n 230/400V; 50-60 Hz; can be used in systems up to 240/440 V AC

Rated residual current $I_{\Delta n}$ mA	Rated current I_n A	Surge current strength > kA	Max. back-up fuse A	Modules	Article no.	Weight g/each	Pack. unit
--	-----------------------	-----------------------------	---------------------	---------	-------------	---------------	------------



2-pole							
10	16	1	63	2	FIP2101	290	1
30	25	1	63	2	FIP2203	290	1
300	25	1	63	2	FIP2230	290	1
30	40	1	63	2	FIP2303	290	1
300	40	1	63	2	FIP2330	290	1



4-pole							
30	25	1	100	4	FIP4203	450	1
300	25	1	100	4	FIP4230	450	1
500	25	1	100	4	FIP4250	450	1
30	40	1	100	4	FIP4303	450	1
300	40	1	100	4	FIP4330	450	1
500	40	1	100	4	FIP4350	450	1
30	63	1	100	4	FIP4403	450	1
300	63	1	100	4	FIP4430	450	1
500	63	1	100	4	FIP4450	450	1
30	80	1	100	4	FIP4503	450	1
300	80	1	100	4	FIP4530	450	1



4-pole							
30	125	1	125	4	FIP4703	500	1
300	125	1	125	4	FIP4730	500	1
500	125	1	125	4	FIP4750	500	1

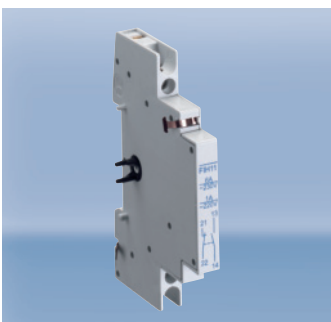

Auxiliary contact
 for RCCBs up to 80 A
 Rated operating current I_e
 at AC-12 for U_e 230V AC 6 A
 at AC-14 for U_e 230V AC 3,6 A
 at DC-13 for U_e 220V UC 1 A

1/2 M

	Article no.	Weight g/each	Pack. Unit
1NO 1NC	FIH11	45	1

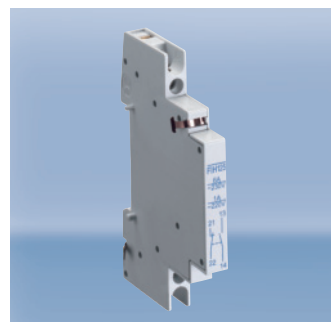

Auxiliary contact
 for RCCB 125 A
 Rated operating current I_e
 at AC-12 for U_e 230V AC 6 A
 at DC-13 for U_e 220V UC 1 A

1/2 M

	Article no.	Weight g/each	Pack. Unit
1NO 1NC	FIH125	40	1

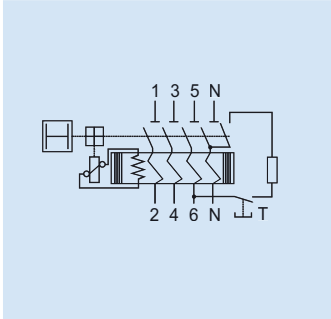

Short-time delayed tripping

RCCBs with short-time delayed trips have a minimum tripping delay of 10 ms, i.e. they must not trip at a residual current impulse of 10 ms duration. Thus the maximum permissible trip times according to IEC/EN 61008 (VDE 0664-10) are kept.

Areas of application:

- in areas with many thunderstorms
- devices that cause high drainage currents when switched on, e.g. panel heating, large amount of fluorescent lamps, fluorescent lamps with a series connection unit, x-ray units and computers

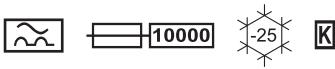

Rated residual current $I_{\Delta n}$ mA	Rated current I_n A	Surge current strength >kA	Max. back-up fuse A	Modules	Article no.	Weight g/each	Pack. Unit
--	-----------------------------	-------------------------------	------------------------	---------	-------------	---------------	------------



4-pole							
30	40	3	100	4	FIK4303	450	1

Selective tripping

RCCBs with selective trip have a switch off time of 60... 110 ms and a high surge current strength of 5 kA. Can be used as upstream group RCCB for selective trip as opposed to downstream standard RCCBs.

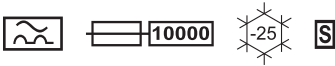

Rated residual current $I_{\Delta n}$ mA	Rated current I_n A	Surge current strength >kA	Max. back-up fuse A	Modules	Article no.	Weight g/each	Pack. Unit
--	-----------------------------	-------------------------------	------------------------	---------	-------------	---------------	------------



4-pole							
300	125	5	125	4	FIS4730	500	1

Description

Function



This device type works according to VDE 0664 -100, valid in Germany, in the detection, evaluation and trip for the requirements for type A, independent of mains voltage. A voltage supply is only necessary for physical reasons for the detection of smooth DC residual currents. This results from all power lines. The function is available from a minimum voltage of 50 V. Therefore a maximum of safety is provided also for the voltage-dependent component of the device function. Even in the case that there is a voltage only on one conductor and thus a fault current flows, the protection is supplied by the mains voltage independent tripping function of the voltage-independent pulsating-current-sensitive device part.

According to the product standard VDE 0664-1 00, RCCBs of type B are designed to be used in three-phase systems with 50/60 Hz and not in the DC voltage network. With electronic equipment, like e.g. on the outgoing side of a frequency converter, AC residual currents of different frequencies can arise as well as the fault current forms described.

Extended tripping conditions are therefore defined for RCCBs of type B for frequencies up to 2 kHz. The tripping characteristics of the RCCBs of type B with rated residual currents of 30 mA and 300 mA are shown in the figure below.

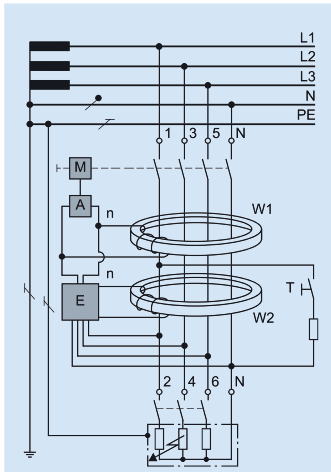
The tripping value of the universal-current-sensitive RCCB of type B always lies within the limit values of the device regulations and, for the rated residual current of 30 mA, also well below the limit curve for dangerous cardiac fibrillation (according to IEC 60479-2).



- A = tripping unit
- M = mechanical components of the protection equipment
- E = electronics for release for smooth DC residual currents
- T = test equipment
- n = secondary winding
- W1 = summation current transformer for detecting of the sinusoidal residual currents 
- W2 = summation current transformer for detecting of the smooth DC residual currents 

Tripping current depending on the frequency

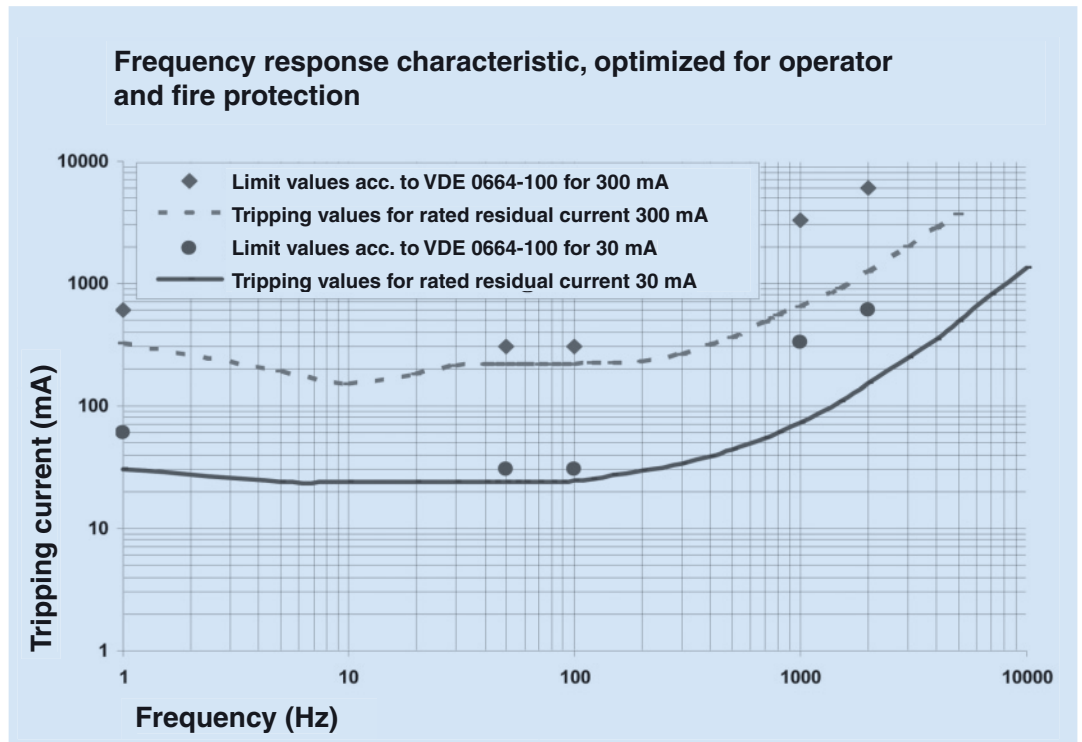

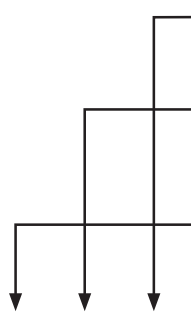



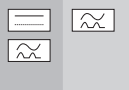

Typ AC are suitable for detecting sinusoidal AC residual currents. For input circuits 1 to 3.

Typ A also detect pulsating DC residual currents as well as sinusoidal AC residual currents. For input circuits 1 to 6.

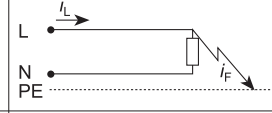
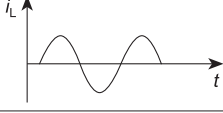
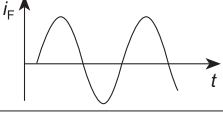
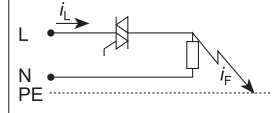
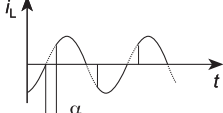
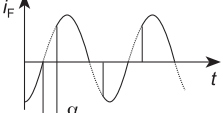
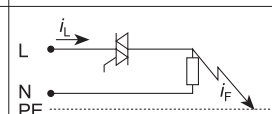
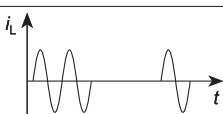
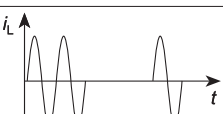
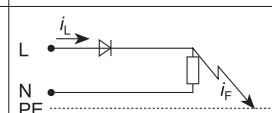
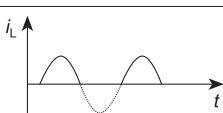
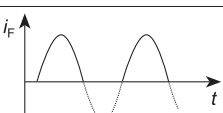
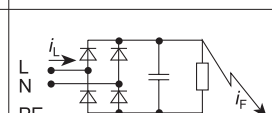
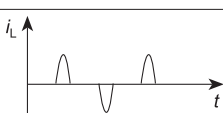
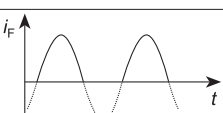
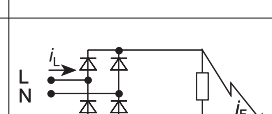
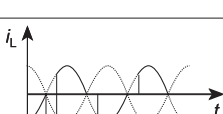
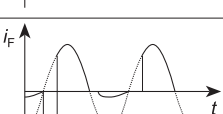
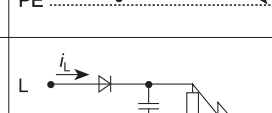
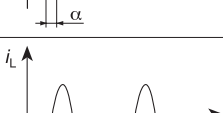
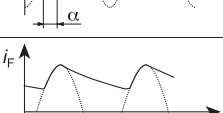
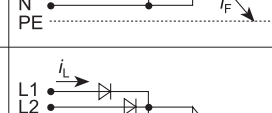
Typ B are used, not only for detecting residual currents of type A, but also for detecting smooth DC residual currents. These RCCBs are suitable for use in the input circuits 1 to 10.

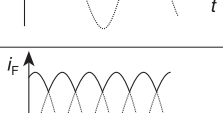
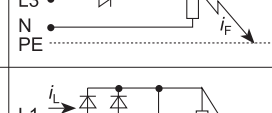
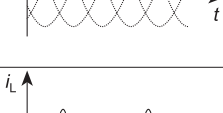
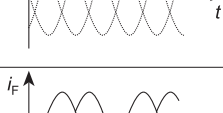
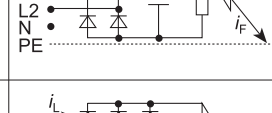
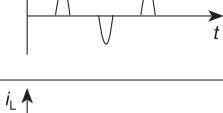
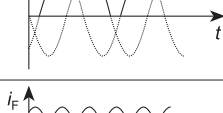
Fault current forms:

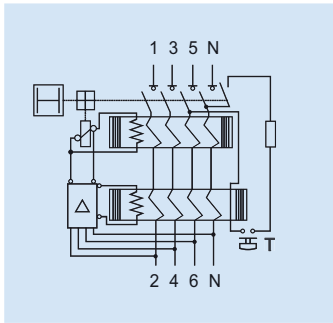
B	A	AC	circuit	load current	residual current	
			1 			
			2 			
			3 			
				4 		
				5 		
				6 		
				7 		
				8 		
				9 		
				10 		



RCCBs of type B, as well as detecting residual current shapes of type A, are also used for detecting smooth DC residual currents and for input circuits 7 to 10 according to table "Technical Data – fault current forms" (see left page).

Areas of application

- Frequency converters, lift control systems, ventilator control systems
- Medical devices like x-ray devices, CT systems
- Photovoltaic systems, UPS systems
- Construction sites according to BGI 608 (electrical equipment on construction sites)
- Variable-speed machine tools
- All types of cranes

Short-time delayed tripping K



Nominal residual current $I_{\Delta n}$ mA	Nominal current I_n A	Surge current strength > kA	Max. back-up fuse A	Modules	Article no.	Weight g/each	Pack. Unit
--	-------------------------------	--------------------------------	------------------------	---------	-------------	---------------	------------



4-pole							
30	25	1	100	4	FI4203A	450	1
300	25	1	100	4	FI4230A	450	1
30	40	1	100	4	FI4303A	450	1
300	40	1	100	4	FI4330A	450	1
30	63	1	100	4	FI4403A	450	1
300	63	1	100	4	FI4430A	450	1
500	63	1	100	4	FI4450A	450	1
30	80	1	100	4	FI4503A	450	1
300	80	1	100	4	FI4530A	450	1

Selective tripping S



Rated residual current $I_{\Delta n}$ mA	Rated current I_n A	Surge current strength >kA	Max. back-up fuse A	Modules	Article no.	Weight g/each	Pack. Unit
--	-----------------------------	-------------------------------	------------------------	---------	-------------	---------------	------------



4-pole							
300	63	3	100	4	FI4430S	450	1

Rated voltage U_n	AC 230 V, suitable for networks up to 250 V
Rated residual current $I_{\Delta n}$ 10 mA	10 mA, 30 mA and 300 mA
Function limit for functions of the test equipment	AC 100 V
Short circuit withstand rating I_{cn} (according to DIN EN 61009)	6 kA and 10 kA
Energy limiting class	3
Frequencies	50 Hz to 60 Hz
Insulation coordination	Overvoltage category III, for degree of pollution according to DIN VDE 0110
EMC	According to DIN EN 61009 and DIN EN 61543
Installation devices	CB 1-pole+N(2 modules), CB-2-pole (3 modules)
Installation position	any
Degree of protection	IP 20 according to DIN 40 050
Connecting terminals	Both-sided multi-function terminal For simultaneous connection of conductors and pin rails
Terminal screws	\pm and Pozidriv 2
Torque	2,5 to 3 Nm
Conductor cross sections	Single and multi-wire conductor: 0,75 to 35 mm ² Stranded wire with ferrule: 0,75 to 25 mm ²

Thermal trip and short circuit trip circuit breaker

Characteristic		B	C
Test currents	Thermal not tripping I_1 (A) > 1 h	$1,13 \times I_n$	$1,13 \times I_n$
	Thermal tripping I_2 (A) < 1 h	$1,45 \times I_n$	$1,45 \times I_n$
	Electromagnetic not tripping I_4 (A) > 0,1 s	$3 \times I_n$	$5 \times I_n$
	Electromagnetic tripping I_5 (A) < 0,1 s	$5 \times I_n$	$10 \times I_n$

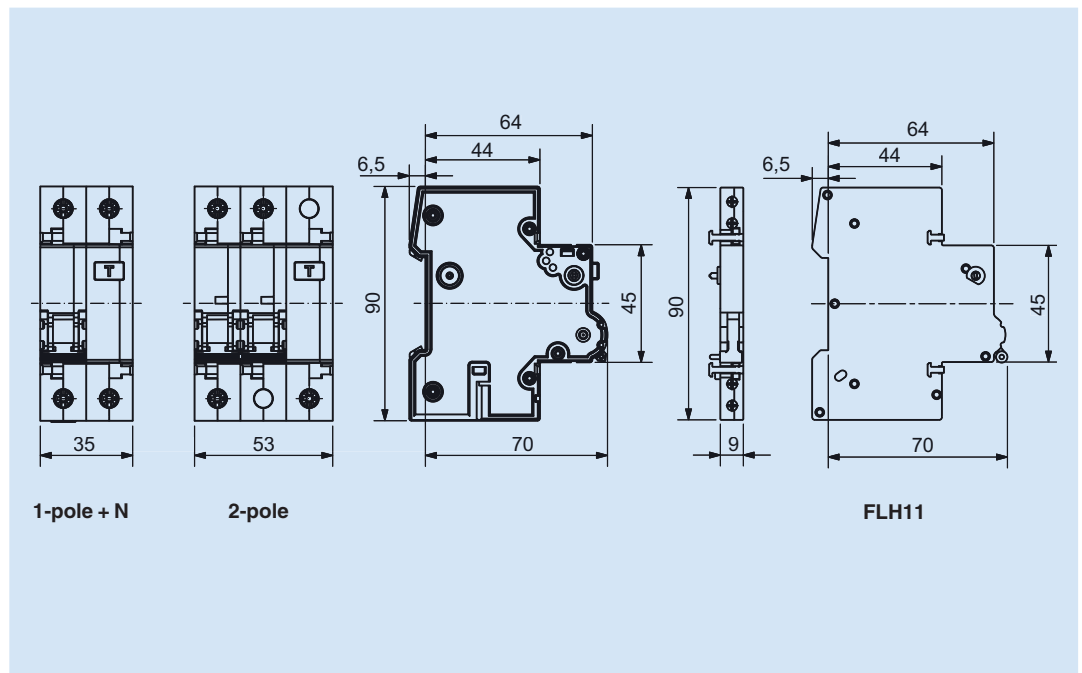

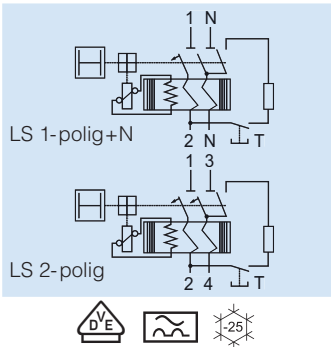

RCBOs offer a compact possibility of implementing wiring protection and protection against personal injury in one device. The RCBO protects itself through its CB part against overload. An undesired overload due to too-high load currents is not possible. One RCBO is assigned to every circuit. So the full fault current is available to every circuit as drainage current. For one fault current in a circuit, only the affected circuit is switched off.

Rated current I_n A	Rated residual current $I_{\Delta n}$ mA	Characteristic		Modules	Weight g/each	Pack. Unit
		B Article no.	C Article no.			

Short circuit withstand rating 6 kA $\frac{6000}{3}$						
MCB 1-pole + N						
6	30	-	FC0603	2	260	1
10	30	FB1003	FC1003	2	260	1
13	30	FB1303	-	2	260	1
16	30	FB1603	FC1603	2	260	1
16	300	FB1630	FC1630	2	260	1
20	30	-	FC2003	2	260	1
25	30	-	FC2503	2	260	1
32	30	-	FC3203	2	260	1
40	30	-	FC4003	2	260	1



Short circuit withstand rating 10 kA $\frac{10000}{3}$						
MCB 1-pole + N						
16	10	FB1601	FC1601	2	270	1



Short circuit withstand rating 10 kA						
MCB 2-pole						
10	30	FB1003N		3	400	1
13	30	FB1303N		3	400	1
16	30	FB1603N	FC1603N	3	400	1



Auxiliary contact

Rated operating current I_e
 at AC-14 for U_e 400V AC 2 A
 at AC-14 for U_e 230V AC 6 A
 at DC-13 for U_e 110/220V UC 1 A
 at DC-13 for U_e 24V UC 6 A
 1/2 M

	Article no.	Weight g/each	Pack. Unit
1NO/ 1NC	FLH11	45	1

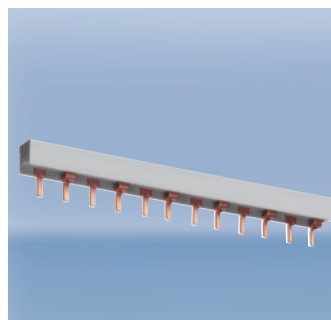

Busbar 2-pole

Pin type
 for RCBOs 2 M
 Single phase + N
 Cross section 16 mm²
 Busbar current 80/130 A

	Article no.	Weight g/each	Pack. Unit
56 M	SB25516	430	20

Short circuit selectivity to fuses in kA										
RCBO 6 kA										
		Rated current I _n (A)								
Characteristic	B	6	10	13	16	20	25	32	40	
	C	6	10	13	16	20	25	32	40	
Fuse according to DIN VDE 0636 operating class	I _n (A)	16								1.)
		0,4								
		0,35								
		20	0,7	0,5	0,45	0,45				
		0,55	0,45	0,4	0,4					
		25	1,1	0,75	0,7	0,7	0,7			
		0,8	0,7	0,6	0,6					
		35	2,0	1,4	1,3	1,3	1,3	1,3		
		1,5	1,4	1,2	1,2	1,2	1,2			
	50	4,1	2,4	2,0	2,0	2,0	2,0	2,0	1,8	
	2,8	2,3	2,0	2,0	2,0	2,0	2,0	2,0	1,8	
	63	6,0	3,4	2,7	2,7	2,7	2,7	2,7	2,7	
	4,7	3,3	3,0	3,0	3,0	3,0	3,0	2,8	2,8	
	80	6,0	4,2	3,6	3,6	3,6	3,6	3,6	3,6	
	6,0	4,2	3,5	3,5	3,5	3,5	3,5	3,5	3,5	
	100	6,0	6,0	6,0	6,0	6,0	6,0	6,0	6,0	
	6,0	6,0	6,0	6,0	6,0	6,0	6,0	6,0	6,0	

1.) There is no more overload selectivity above the step line.

Short circuit selectivity to fuses in kA						
RCBO 10 kA						
		Rated current I _n (A)				
Characteristic	B	10	13	16		
	C	10	13	16		
Fuse according to DIN VDE 0636 operating class	I _n (A)	16			1.)	
		0,55	0,5	0,5		
		0,5	0,5	0,5		
		20	0,8	0,75	0,75	
		0,8	0,7	0,7		
		35	1,5	1,4	1,4	
		1,5	1,3	1,3		
		50	2,8	2,3	2,3	
		2,7	2,3	2,3		
	63	4,6	3,9	3,9		
	5,0	4,0	4,0			
	80	7,0	6,0	6,0		
	7,0	5,0	5,0			
	100	10,0	10,0	10,0		
	10,0	10,0	10,0	10,0		

1.) There is no more overload selectivity above the step line.

Description Distribution Boards	Page 58
Flush mounted Distribution Boards	Page 60
Hollow-Wall Distribution Boards	Page 60
Surface mounted Distribution Boards	Page 61
Accessories	Page 62
Special Distribution Boards	Page 63



Distribution Boards



Large wiring spaces, easy installation and stability are the key features of our flush-mounting and hollow-wall distribution board range.



Moulded wall anchors and an all-round nail strip hold the wall box safely in place (rear view with wall anchor installed).

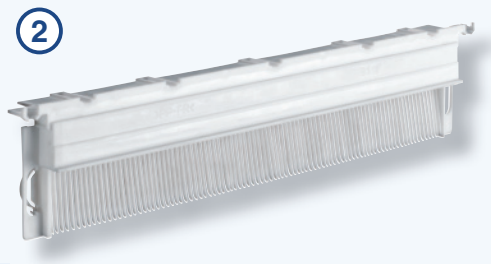
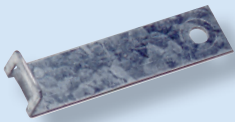

Patented self-latching sliding section with automatically retractable comb pins. No need to break or cut out cable glands; wiring can be easily installed.

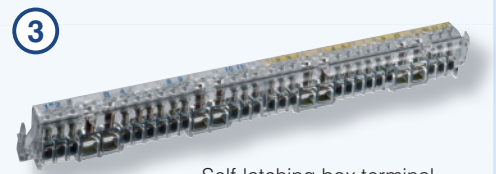

Self-latching box terminal strip for wire connection up to 25 mm² (in) and 10 mm² (out). Finger safe according to BGV A2 (VBG 4). Screws are open for shipping and cannot be lost.

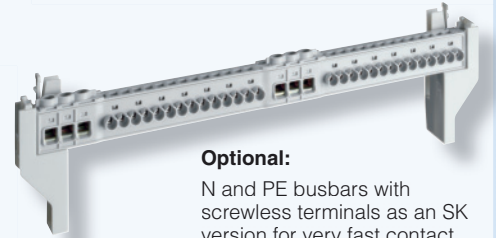

Optional:

N and PE busbars with screwless terminals as an SK version for very fast contact.

- incoming terminals: up to 16 mm² box terminal.
- outgoing terminals: screwless up to 4 mm².

Finger safe according to BGV A2 (VBG 4). Snap-on mounting or optional screw-type mounting of the adapter.

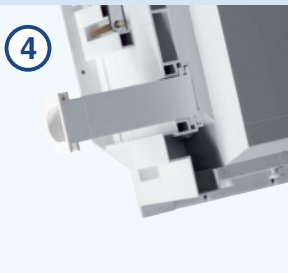

Ready-formed connections for sleeves at top and bottom (rear view with sleeve installed). Also suitable for cross wiring.

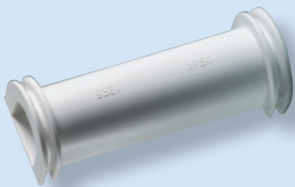

Double wall for good stability.



Additional neutral terminal or additional PE terminal available as an accessory.

You will always find what you need with ABL SURSUM's distribution board range. Quality products from professionals for professionals!

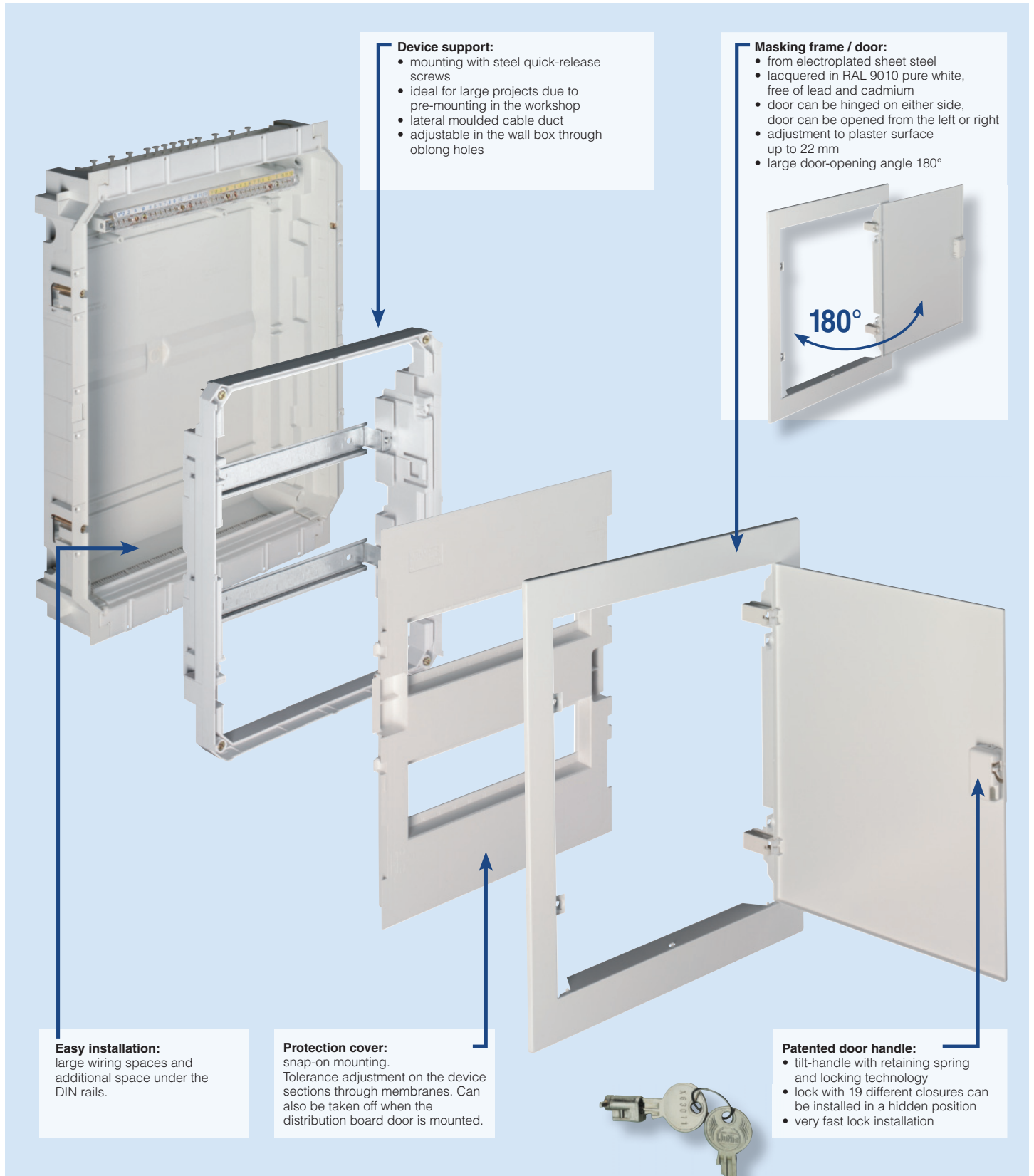

Device support:

- mounting with steel quick-release screws
- ideal for large projects due to pre-mounting in the workshop
- lateral moulded cable duct
- adjustable in the wall box through oblong holes

Masking frame / door:

- from electroplated sheet steel
- lacquered in RAL 9010 pure white, free of lead and cadmium
- door can be hinged on either side, door can be opened from the left or right
- adjustment to plaster surface up to 22 mm
- large door-opening angle 180°



Easy installation:

large wiring spaces and additional space under the DIN rails.

Protection cover:

snap-on mounting. Tolerance adjustment on the device sections through membranes. Can also be taken off when the distribution board door is mounted.

Patented door handle:

- tilt-handle with retaining spring and locking technology
- lock with 19 different closures can be installed in a hidden position
- very fast lock installation



Note:
all article numbers with
ending in SK have terminal
blocks with screwless
terminals

Flush mounted Distribution Boards



according to DIN 43871, DIN VDE 0603 and EN 60439
for installing 68 mm installation devices, I_n 63 A, IP 30

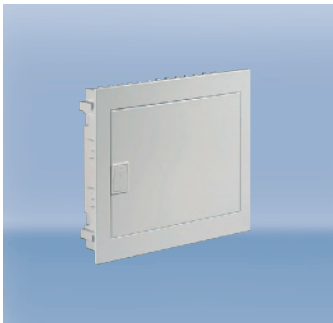

Flush mounted distribution boards

1 row
with N and PE terminals
Recess dimensions:
333 x 290 x 92 mm

Colour	Article no.	Weight g/each	Pack. unit
white	UV12	2100	1
white	UV12SK	2100	1



Flush mounted distribution boards

2 rows
with N and PE terminals
Recess dimensions:
333 x 415 x 92 mm

Colour	Article no.	Weight g/each	Pack. unit
white	UV24	2900	1
white	UV24SK	2900	1



Flush mounted distribution boards

3 rows
with N and PE terminals
Recess dimensions:
333 x 560 x 92 mm

Colour	Article no.	Weight g/each	Pack. unit
white	UV36	3800	1
white	UV36SK	3800	1



Flush mounted distribution boards

4 rows
with N and PE terminals
Recess dimensions:
333 x 685 x 92 mm

Colour	Article no.	Weight g/each	Pack. unit
white	UV48	4600	1
white	UV48SK	4600	1

Note:
all article numbers with
ending in SK have terminal
blocks with screwless
terminals

Hollow-Wall Distribution Boards



according to DIN 43871, DIN VDE 0603 and EN 60439
for installing 68 mm installation devices, I_n 63 A, IP 30



Hollow-wall distribution boards

1 row
with N and PE terminals
Wall section:
333+1,5 x 290+1,5 x 92 mm

Colour	Article no.	Weight g/each	Pack. unit
white	HV12	2200	1
white	HV12SK	2200	1



Hollow-wall distribution boards

2 rows
with N and PE terminals
Wall section:
333+1,5 x 415+1,5 x 92 mm

Colour	Article no.	Weight g/each	Pack. unit
white	HV24	3000	1
white	HV24SK	3000	1



Hollow-wall distribution boards

3 rows
with N and PE terminals
Wall section:
333+1,5 x 560+1,5 x 92 mm

Colour	Article no.	Weight g/each	Pack. unit
white	HV36	3900	1
white	HV36SK	3900	1



Hollow-wall distribution boards

4 rows
with N and PE terminals
Wall section:
333+1,5 x 685+1,5 x 92 mm

Colour	Article no.	Weight g/each	Pack. unit
white	HV48	4700	1
white	HV48SK	4700	1

according to DIN 43871, DIN VDE 0603 and EN 60439
for installing 68 mm installation devices, I_n 63 A, IP 30

Surface mounted distribution boards

The totally insulated thermoplastic distribution board range in the colour RAL 9010 covers 1 to 4-row distribution boards for the installation of 68 mm installation devices.

The device support is closed at the back and enables wiring access not only from all sides but also by breaking open the rear panel from behind. The cover is mounted on the device support with quick-release screws.



Surface mounted distribution boards

1 row
with N and PE terminals
Dimensions: 275 x 221 x 74 mm

Colour	Article no.	Weight g/each	Pack. unit
white	AV12	732	1

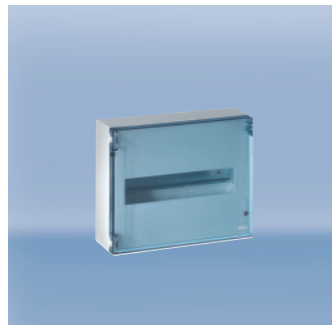

Surface mounted distribution boards with doors

1 row
with N and PE terminals
Dimensions: 275 x 221 x 103 mm

Colour	Article no.	Weight g/each	Pack. unit
blue	AV12TB	962	1
white	AV12T	962	1



Surface mounted distribution boards

2 rows
with N and PE terminals
Dimensions: 275 x 346 x 74 mm

Colour	Article no.	Weight g/each	Pack. unit
white	AV24	1038	1

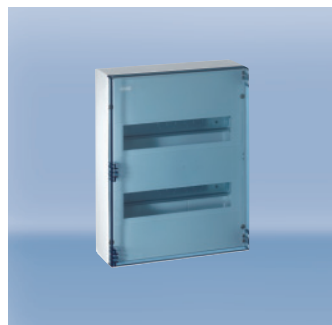

Surface mounted distribution boards with doors

2 rows
with N and PE terminals
Dimensions: 275 x 346 x 103 mm

Colour	Article no.	Weight g/each	Pack. unit
blue	AV24TB	1378	1
white	AV24T	1378	1



Surface mounted distribution boards

3 rows
with N and PE terminals
Dimensions: 275 x 491 x 74 mm

Colour	Article no.	Weight g/each	Pack. unit
white	AV36	1385	1



Surface mounted distribution boards with doors

3 rows
with N and PE terminals
Dimensions: 275 x 491 x 103 mm

Colour	Article no.	Weight g/each	Pack. unit
blue	AV36TB	1905	1
white	AV36T	1905	1



Surface mounted distribution boards

4 rows
with N and PE terminals
Dimensions: 275 x 616 x 74 mm

Colour	Article no.	Weight g/each	Pack. unit
white	AV48	1778	1

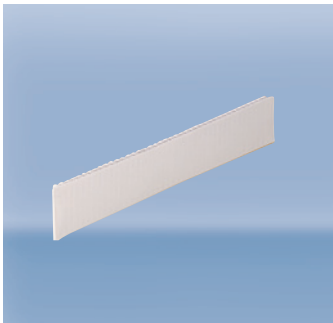

Blank masking strip

14 modules

Colour	Article no.	Weight g/each	Pack. unit
grey	0380260	42	100
white	0380410	42	100



Additional neutral terminal

Terminal positions:
3 x 4 / 1 x 25 mm²

Article no.	Weight g/each	Pack. unit
4576000	29	1



Door lock

For flush mounted and hollow-wall distribution boards
19 different closures possible

Article no.	Weight g/each	Pack. unit
4577000	18	1

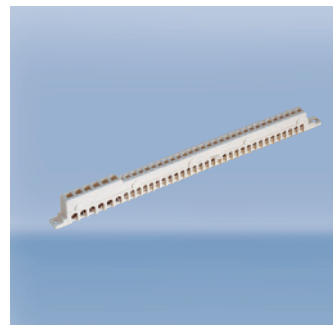

Additional PE terminal block

Terminal positions:
30 x 4 / 6 x 16 mm²

Article no.	Weight g/each	Pack. unit
6224000	190	1



Connecting sleeve

For the horizontal connection of flush mounted and hollow-wall distribution boards
1 set (2 pieces)

Article no.	Weight g/each	Pack. unit
4584000	32	1



Wall anchor

For additional anchoring of the wall box
1 set (4 pieces)

Article no.	Weight g/each	Pack. unit
4100000	28	1

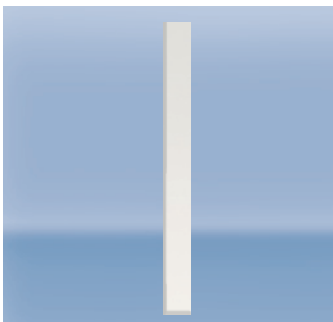

Partition

3 rows vertical 4381000
4 rows vertical 4382000
3 and 4 rows horizontal 4383000
for flush mounted, surface mounted and hollow-wall distribution boards

Article no.	Weight g/each	Pack. unit
4381000	44	1
4382000	55	1
4383000	32	1



Door key kit

For installation in surface mounted distribution boards
0059510
Replacement key
0059100

Article no.	Weight g/each	Pack. unit
0059510	16	1
0059100	16	1



Complete door for surface mounted distribution boards

1 row TAV1 / TAV1B
2 rows TAV2 / TAV2B
3 rows TAV3 / TAV3B

Colour	Article no.	Weight g/each	Pack. unit
blue	TAV1B	230	1
	TAV2B	340	1
	TAV3B	520	1
white	TAV1	230	1
	TAV2	340	1
	TAV3	520	1



Transparent window for surface mounted distribution boards

T1 – with frame to be snapped into the device section

TP1 – with frame to be snapped into the device section, sealable

Colour	Article no.	Weight g/each	Pack. unit
white	T1	127	1
white	TP1	132	1



Flush mounted distribution boards

for 6 modules

Totally insulated 
Recess dimensions:
150 x 150 x 80 mm

Colour	Article no.	Weight g/each	Pack. unit
grey	0141061	368	1/10

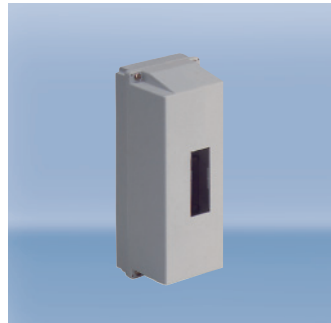

Surface mounted enclosure

for 2 modules
Dimensions: 46 x 145 x 58,5 mm

Colour	Article no.	Weight g/each	Pack. unit
grey	IKV.2	87	10



Surface mounted enclosure

for 4 modules
without terminals
Dimensions: 82 x 145 x 58,5 mm

Colour	Article no.	Weight g/each	Pack. unit
grey	IKV.4	110	5



Surface mounted enclosure

for 3 modules
with N and PE terminals
Dimensions: 82 x 145 x 58,5 mm

Colour	Article no.	Weight g/each	Pack. unit
grey	IKV.4N1	110	5



Surface mounted enclosure

for 10 modules
without terminals
Dimensions: 200 x 145 x 58,5 mm

Colour	Article no.	Weight g/each	Pack. unit
grey	IKV10	300	2



Surface mounted enclosure

for 10 modules
with N and PE terminals
Dimensions: 200 x 145 x 58,5 mm

Colour	Article no.	Weight g/each	Pack. unit
grey	IKV10N1	300	2



Housing

Splash-proof IP 44
with DIN rail
for 5 modules
Dimensions: 118 x 170 x 131 mm

Colour	Article no.	Weight g/each	Pack. unit
grey	B 40.01	510	1

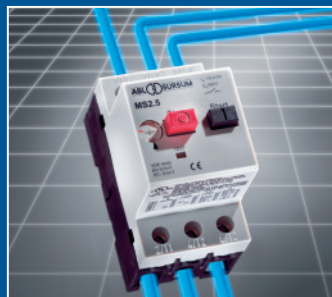
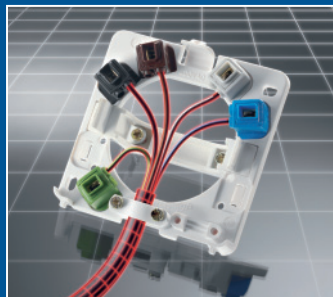
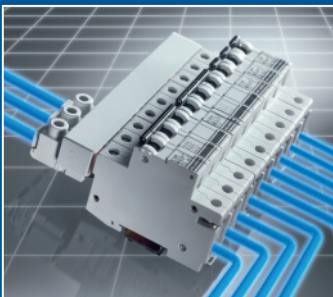
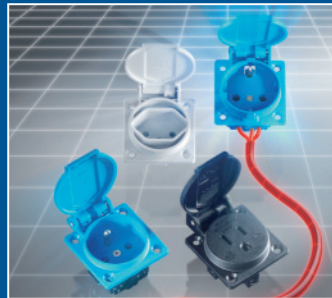
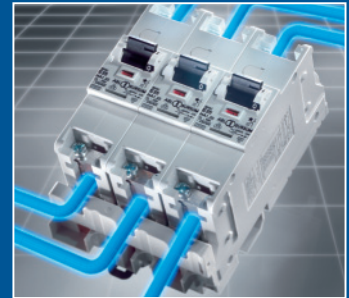
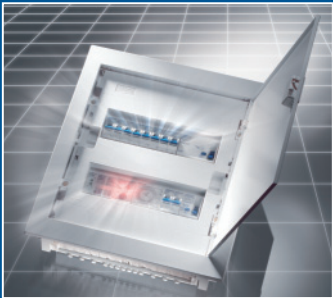
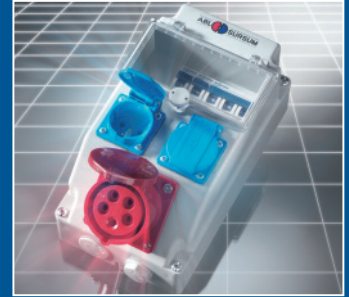
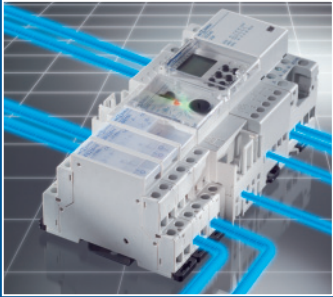

ABL SURSUM
Bayerische Elektrozubehör GmbH & Co. KG

Ottensooser Strasse 22
 D-91207 Lauf / Pegnitz
 Germany

Telephone: +49 (0)9123 188-0
 Facsimile: +49 (0)9123 188-188

Postfach 10 02 47
 D-91192 Lauf / Pegnitz
 Germany

E-Mail: info@abl-sursum.com
 Internet: www.abl-sursum.com

JD Auspice Co.,Ltd.

Tel: 02-2595-9780

Fax: 02-2595-9412

Mail: jd.auspice@msa.hinet.net

Web: <http://www.jdauspice.com>