



PV photovoltaic system Overcurrent and overvoltage protection



note: subject to change without any notice, JDA pay no responsibility

PV photovoltaic systems

Overcurrent and overvoltage protection

Introduction

Photovoltaic systems are made of photovoltaic panels, cables, fuses, overvoltage arresters and power inverter. Photovoltaic panels utilise the power of sun light to converters photons to DC current.

Electricity generated by solar panels is then fed into a power inverter that converts DC current to AC current. PV fuses has been developed to protect against overcurrent.

ETITEC B, C-PV series of over voltage surge protective devices has been developed to protect against direct and indirect lightning discharges and is intended to protect photovoltaic systems.

The circuit topology consists of two varistors stages each protected by a thermal disconnection device.

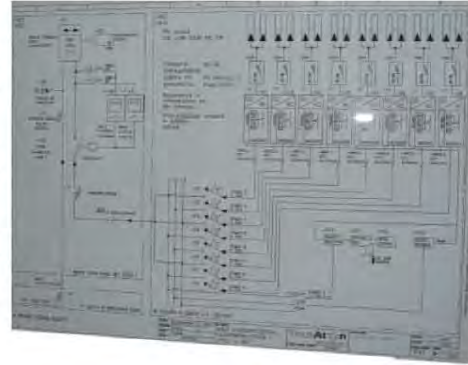

Overcurrent protection

Array with three or more strings of panels:

PV systems that have three or more strings connected in parallel need to have each string protected by fuses.

Systems that have less than three strings will not generate enough fault current to damage the conductors/solar panels.

Normally there are two PV fuses connected on each string (+ and - pole), that protect conductors/solar panels from damage and eliminate any safety hazards.

Fuses isolate the faulted string. The rest of PV system can continue to generate electricity.

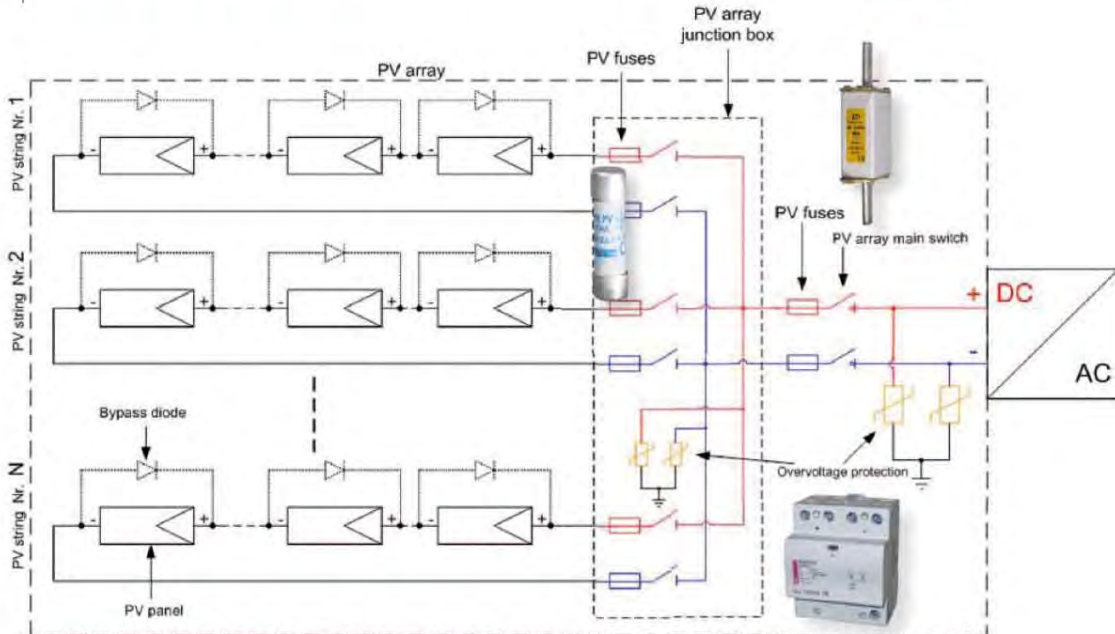

PV fuse selection:

- Maximum DC Operating voltage of the fuse must be:
 $1,2 \times$ nominal voltage of string
- Rated current In of the fuse must be higher or equal than:
 $1,5 \times I_{sc}$
(Isc-short circuit current of panel)



note: subject to change without any notice, JDA pay no responsibility



CH 10 PV fuse selection

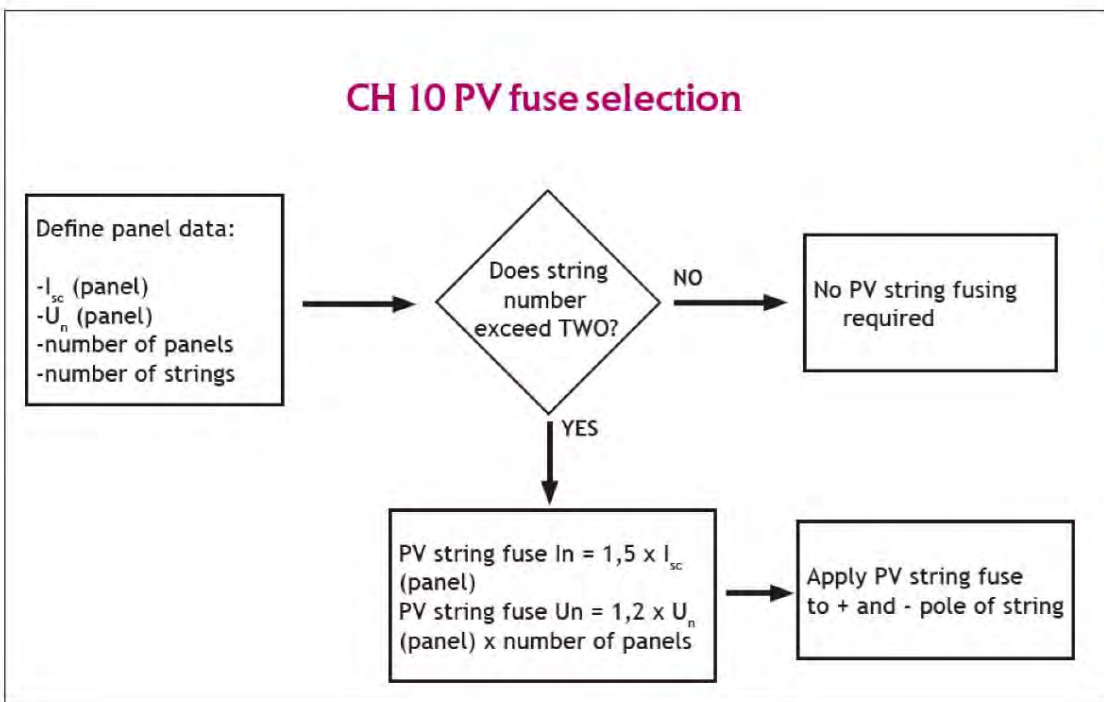

NH PV fuse selection

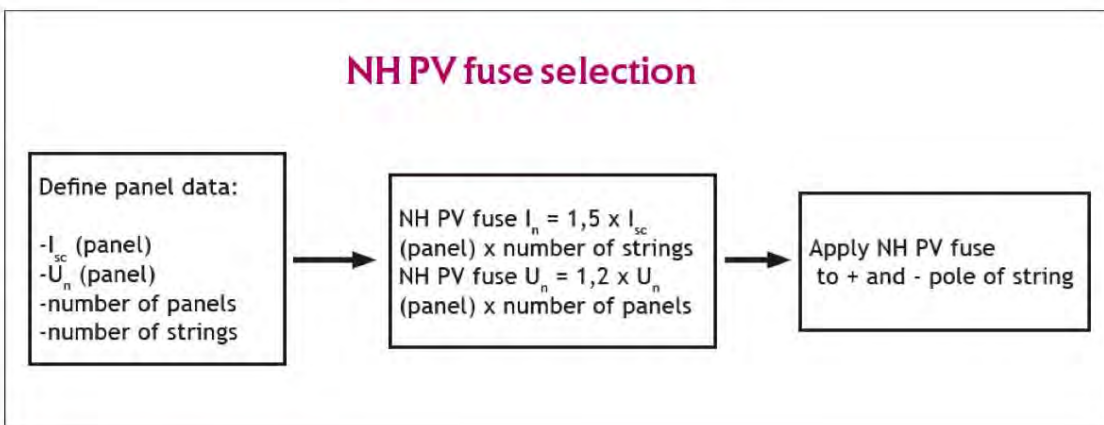

Overtoltage protection selection

ETITEC PV selection

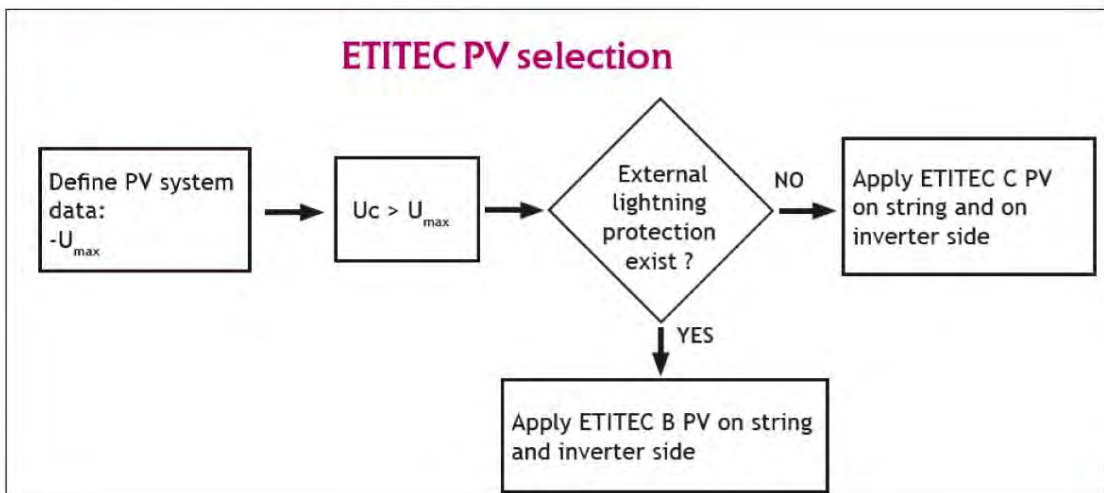

ETITEC B-PV for photovoltaic system on a building with External Lightning Protection

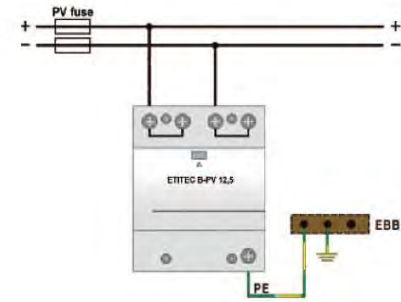
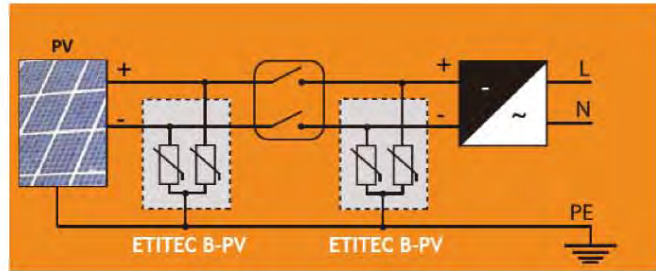
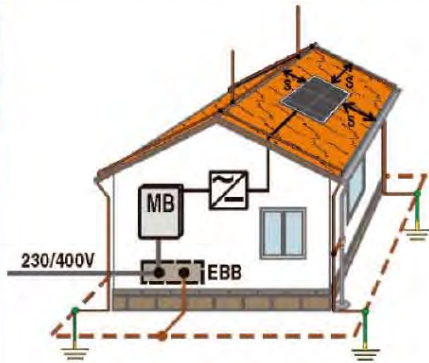

T - Connection ETITEC B-PV

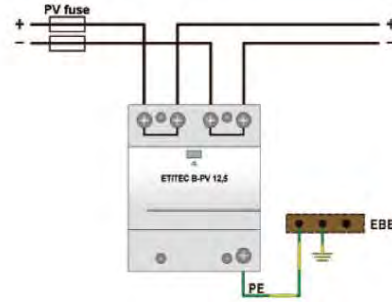

V - Connection ETITEC B-PV

ETITEC C-PV for photovoltaic system on a building without External Lightning Protection

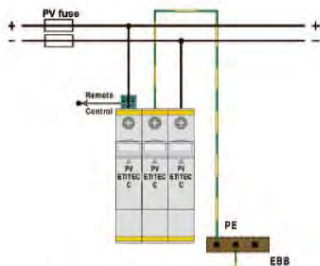
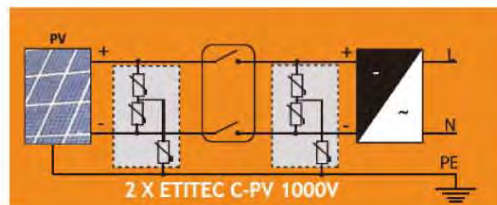
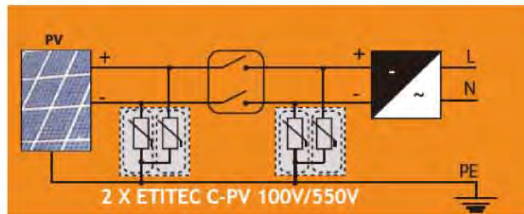
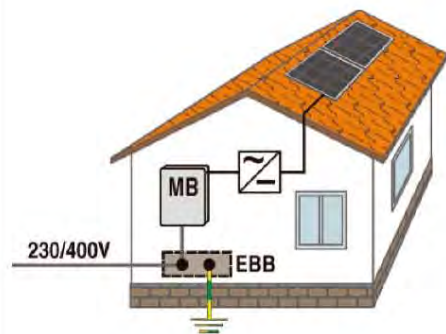

T connection ETITEC C-PV

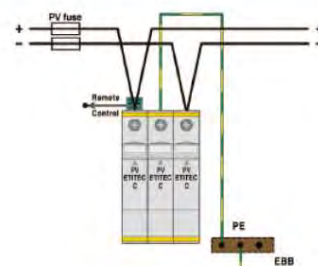

V connection ETITEC C-PV

note: subject to change without any notice, JDA pay no responsibility

CH 10 PV - Fuse-links

General characteristics

Rated voltage	1000V d.c. L/R=2ms
Breaking capacity	30kA d.c.
Standards	IEC 60269-4
Application	For protection of photovoltaic strings.

CH 10 PV

Size	I_n [A]	Code No.	Pre-arcing Joule integral [A ² s] L/R=2ms	Operating Joule integral [A ² s] L/R=2ms	Power dissipation [0,7 x I _n] ² P _d [W]	Power dissipation [I _n] ² P _d [W]	Weight [g]	Packaging [pcs]
10 x 38	2	002625101	1,3	3,5	0,47	1,00	10	10
	4	002625102	3,3	28	0,52	1,25		
	6	002625103	5,5	45	0,73	1,65		
	8	002625104	8	62	0,93	1,9		
	10	002625105	11	88	1,06	2,3		
	12	002625106	23	180	1,03	2,4		
	16	002625107	35	270	1,00	2,5		
	20	002625108	50	430	1,18	3,25		
	25*	002625109	75	620	1,25	3,45		

* 900V d.c.

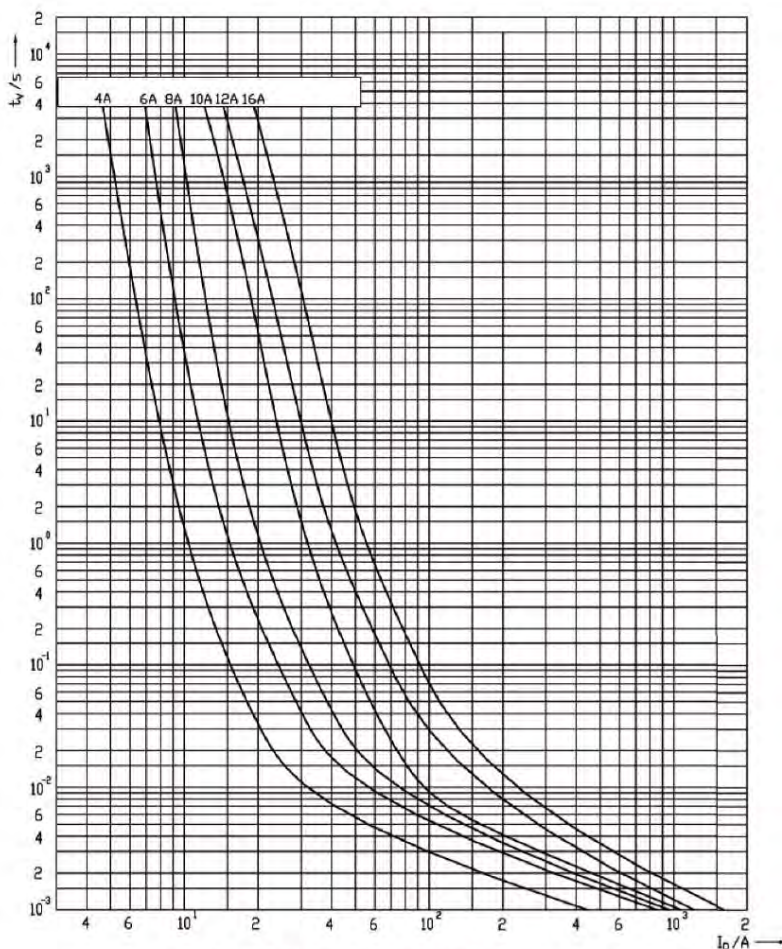
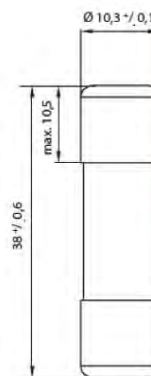

CH 10 PV t-I characteristics

NH DC 750V - Fuse-links

General characteristics

Rated voltage	750V d.c. (L/R = 15ms)
Breaking capacity	20 kA d.c.
Standards	IEC 60269-2, IEC 60269-4
Application	Fuse-link for DC application. Applied in fuse base PK0 and PK1 DC.

I _n [A]	Code No. Size 0	Code No. Size 1C	Power dissipation [W]	Pre-arcing Joule integral [I ² t] (L/R = 15ms)	Operating Joule integral [I ² t] (L/R = 15ms)	Weight [g]	Packaging [pcs]
32	004110308	004110300	7,6	70	370	280/0 300/1C	3
40	004110310	004110301	8,8	135	650		
50	004110311	004110302	11,0	250	1.000		
63	004110312	004110303	13,5	520	1.790		
80	004110313	004110304	17,0	1.050	3.000		
100	004110314	004110305	21,0	2.580	6.140		
125	004110315	004110306	25,2	6.300	14.090		
160	004110316	004110307	31,2	13.060	27.220		



NH DC 1000V - Fuse-links

General characteristics

Rated voltage	1000V d.c. (L/R = 2ms)
Breaking capacity	20 kA d.c.
Standards Fuse-links	IEC 60269-2, IEC 60269-4
Application	Fuse-link for DC application. Applied in fuse base PK0 and PK1 DC.

I _n [A]	Code No. Size 0	Code No. Size 1C	Power dissipation [W]	Pre-arcing Joule integral [I ² t] (L/R = 2ms)	Operating Joule integral [I ² t] (L/R = 2ms)	Weight [g]	Packaging [pcs]
32	004110381	004110371	7,6	52	430	280/0 300/1C	3
40	004110383	004110373	8,8	96	730		
50	004110384	004110374	11,0	155	920		
63	004110385	004110375	13,5	290	1.760		
80	004110386	004110376	17,0	520	3.160		
100	004110387	004110377	21,0	1.110	5.280		
125	004110388	004110378	25,2	2.800	11.340		
160*	004110389	004110379	31,2	5.950	20.750		

* 900V d.c.

Size	A	B	C	D
0	125	35	50	60
1C	135	40	55	65

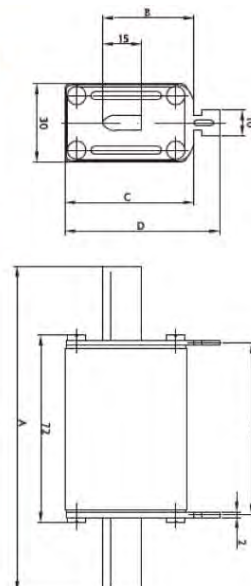



NH DC 1100V - Fuse-links

General characteristics	
Rated voltage	1100V d.c. (L/R = 5ms)
Breaking capacity	10 kA d.c.
Standards	IEC 60269-2, IEC 60269-4
Application	Fuse-link for DC application. Applied in fuse base U1-3-1/1200/H



NH DC 1100V									
Size	I _n [A]	Code No.			Power dissipation [W]	Pre-arcing Joule integral [Pt] (L/R = 5ms)	Operating Joule integral [Pt] (L/R = 5ms)	Weight [g]	Packaging [pcs]
		Standard indicator (pic.1)	Trip indicator - K (pic.2)	S ₁₇₀ screw contact (pic.3)					
1	63	004110426	004110431	004110435	15,0	2.720	3.520	750	1
	80	004110427	004110432	004110436	17,0	4.000	5.500		
	100	004110428	004110433	004110437	20,0	6.500	9.000		
	125	004110429	004110434	004110438	23,0	11.000	15.000		
2	160	004110410	004110414	004110420	35,0	19.400	28.640	1050	1
	200	004110430	004110415	004110421	42,0	40.000	60.000		
3	250	004110413	004110417	004110423	46,0	85.260	117.400	1360	1
	315	004110425	004110419	004110424	54,0	166.800	221.900		

Picture 1

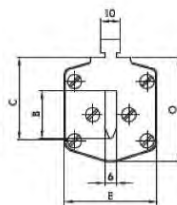
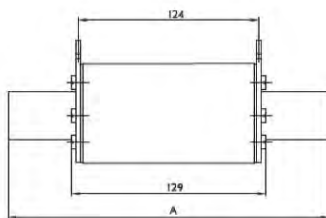

Picture 2

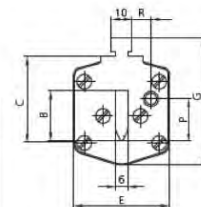
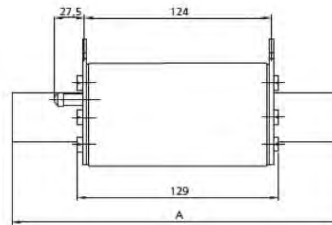

Picture 3

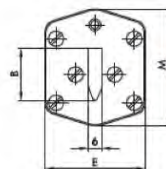
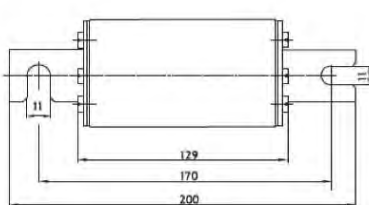

Size	Dimensions [mm]								
	A	B	C	E	G	P	R	M	O
1	194	24	40	46	61,5	20,5	13,7	50	46
2	209	30	48	54	71	27,3	16,2	59	54
3	209	37	60	64	82	35,6	17,0	70	64

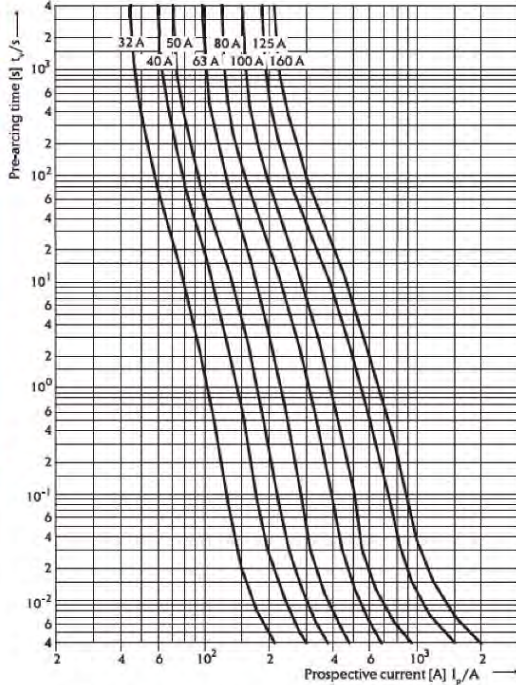

NH DC 750V, 1000V t-I characteristics

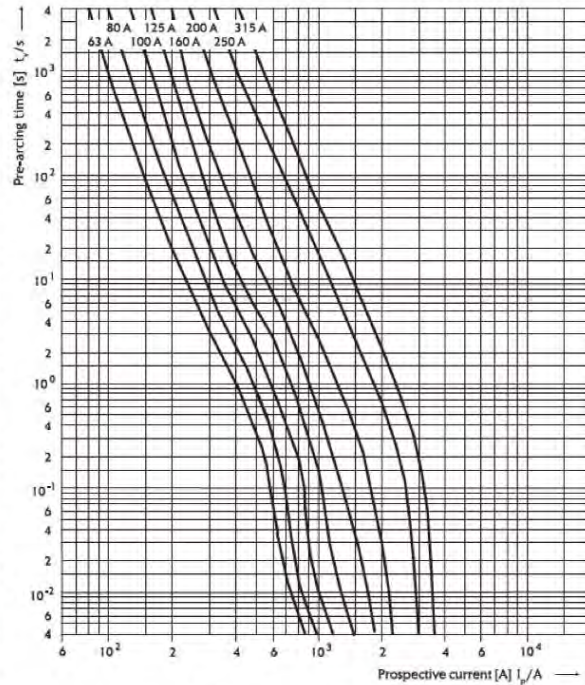

NH DC 1100V t-I characteristics

PCF 10 DC - Fuse disconnecter

General characteristics

Rated voltage	900V d.c.	1000V d.c.
Rated current	max. 25A	max. 20A
Max. fuse link power dissipation	3 W	
Cross section of connecting wire	0,5 mm ² - 10 mm ² (AWG 8-20 solid)	
Pole build-in width	18 mm	
Mounting on the rail	EN 60715 (EN 50022)	
Utilization category	DC-20B	
Standards Fuse-links	IEC 60269-2:2006 UL 284-4	
Standards - Fuse disconnecter	IEC 60947-1 Ed. 4.0 EN 60947-1:1999+A1+A2 IEC 60947-3 Ed. 2.1 EN 60947-3:1999+A1:2001	



PCF 10 DC

Number of poles	U ₁ /U ₂ [V]	I _{max} [A]	Code No.	Indicator	Weight [g]	Packaging [pcs]
1P	900	25	002550301	-	58	12/336
2P	900	25	002550303	-	120	6/168
1P	900	25	002550311	LED	58	12/336
2P	900	25	002550313	LED	120	6/168
1P	1000	20	002550201	-	58	12/336
2P	1000	20	002550203	-	120	6/168
1P	1000	20	002550211	LED	58	12/336
2P	1000	20	002550213	LED	120	6/168

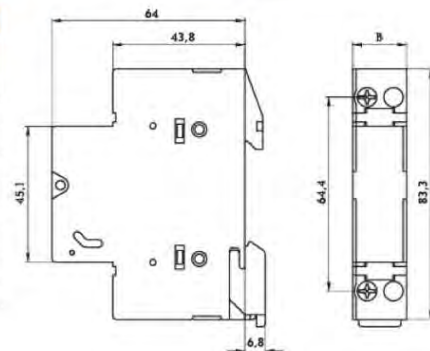

note: subject to change without any notice, JDA pay no responsibility

Fuse base U1-3 DC 1000V

General characteristics

Rated voltage	1000V d.c.
Rated current	250A, 400A, 630A
Insulation class	C-VDE 0110
Standards Fuse-links	EN 60269, IEC 60269, DIN VDE 0636, DIN 43620, DIN 43623

Fuse base U1-3 DC 1000V

Type	I _n [A]	Code No.	Mechanical fuse monitor	Weight [g]	Packaging [pcs]
U1-1/1200/H	250	004122027	without	550	1
U1-1/1200/H/K	250	004122028	with	600	
U2-1/1200/H	400	004122029	without	930	
U2-1/1200/H/K	400	004122030	with	1000	
U3-1/1200/H	630	004122031	without	1200	
U3-1/1200/H/K	630	004122032	with	1250	

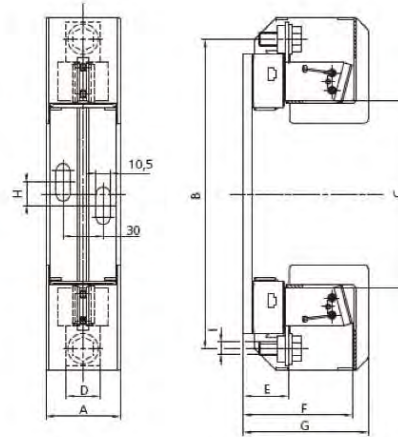

Type	Dimensions [mm]								
	A	B	C	D	E	F	G	H	I
U1-1/1200/H	56	232	140	25	37	84,5	96	17,5	M10
U2-1/1200/H	64	257	140	30	37	100	103	17,5	M10
U3-1/1200	68	270	140	40	38	103	-	25	M12

Fuse base PK 1 DC

General characteristics

Rated voltage	1000V d.c.
Rated current	250A
Insulation class	C-VDE 0110
Standards Fuse-links	EN 60269, IEC 60269, DIN VDE 0636, DIN 43620, DIN 43623

Fuse base PK 1 DC

Type	I _n [A]	Code No.	Weight [g]	Packaging [pcs]
PK 1	250	004122025	598	1
PK 1 - 160	250	004122026	665	

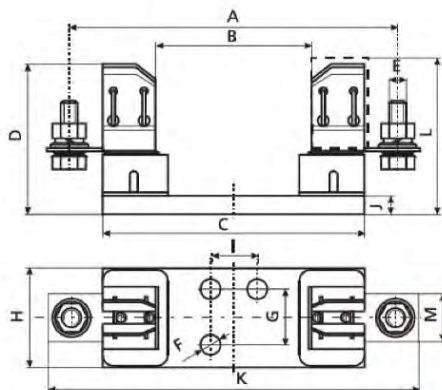

Type	Dimensions [mm]												
	A	B	C	D	E	F	G	H	I	J	K	M	
PK1	175	80	141	81	M10	Ø10,5	30	55	25	10	200	26	
PK1-160	193	257	160	81	M10	Ø10,5	30	55	25	10	220	26	



ETITEC - Lightning and Surge Arresters for Photovoltaic System

ETITEC B-PV series of overvoltage surge protective devices has been developed to protect against direct and indirect lightning discharges and is intended to protect photovoltaic systems. The circuit topology consist of two varistors stages each protected by a thermal disconnection device.

General characteristics

Category IEC/EN/VDE Class I, II/Type 1,2/B+C	High surge discharge ratings: $I_{imp} = 12,5kA/\text{per pole}$, $I_{max} = 40kA/\text{per pole}$
Location of use: Photovoltaic systems- PV module side	Internal protection and safety: Separate thermal disconnecter for each MOV block
Protective element : High Energy MOVs	Status indication: Mechanical flag + remote signalization contacts (RC)

ETITEC B - PV

Type	Code No.	U_c [V DC]	I_{imp} [kA]	Weight [g]	Packaging [pcs]
ETITEC B-PV 550/12,5 (10/350)	002445202	550	12,5	300	1/3
ETITEC B-PV 1000/12,5 (10/350)	002445203	1000		350	
ETITEC B-PV 550/12,5 (10/350) RC	002445204	550		310	
ETITEC B-PV 1000/12,5 (10/350) RC	002445205	1000		360	

RC - Remote signalization contacts



ETITEC B-PV 550/12,5 (10/350)



ETITEC B-PV 1000/12,5 (10/350)

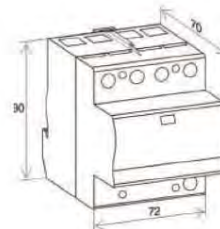
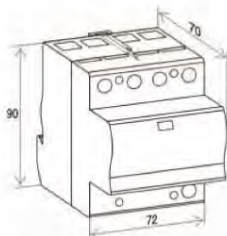

ETITEC C-PV series of overvoltage surge protective devices has been developed to protect against indirect discharges and is intended to protect photovoltaic systems. The circuit topology consist of two (three) varistors stages each protected by a thermal disconnection device.

General characteristics

Category IEC/EN/VDE Class II/Type 2/C	High surge discharge ratings: $I_{sm} = 20kA$ /per pole, $I_{max} = 40kA$ /per pole
Location of use: Branch sub-distribution boards	Internal protection and safety: Thermal disconnecter for each MOV block
Protective element : High Energy MOVs	Status indication: Mechanical flag + remote signalization contacts (RC)

ETITEC C - PV

Type	Code No.	Uc [V DC]	I_{imp} [kA]	Weight [g]	Packaging [pcs]
ETITEC C-PV 100/20	002445206	100	20	200	1/7
ETITEC C-PV 550/20	002445207	550		255	1/7
ETITEC C-PV 1000/20	002445208	1000		365	1/5
ETITEC C-PV 100/20 RC	002445209	100		210	1/7
ETITEC C-PV 550/20 RC	002445210	550		265	1/7
ETITEC C-PV 1000/20 RC	002445211	1000		375	1/5

RC - Remote signalization contacts



ETITEC C-PV 100, 550/20



ETITEC C-PV 1000/20

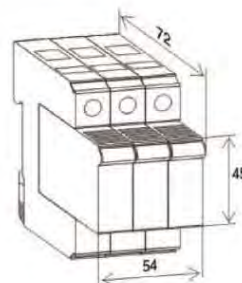
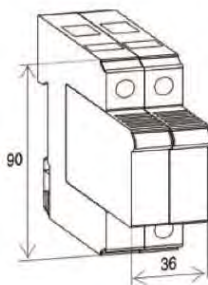



日場國際事業股份有限公司
JD Auspice Co., Ltd.



 www.jdauspice.com



 @jdauspice



 ID : @jdapv