



日揚國際事業股份有限公司
JD Auspice Co., Ltd.

DC MCCB DC SWITCH



Catalogue

note: subject to change without any notice, JDA pay no responsibility



MCCB for DC Application

- Susol MCCB is suitable for DC application such as Photovoltaic Circuit Breaker, UPS and datacenter
- DC short circuit test tested by VDE
- Higher nominal voltage range up to 1000 VDC
- Rated Current : 16A~800A
- No of Pole: 2/3/4Pole
- Available for AC/DC application



		TD100	TD160	TS100	TS160	TS250	TS400	TS630	TS800														
Frame size	(AF)	100	160	100	160	250	400	630	800														
Rated current, In(A)		16, 20, 25, 32, 40, 50, 63, 80, 100	100, 125, 160	40, 50, 63, 80, 100	100, 125, 160	125, 160 200, 250	300, 400	500, 630	700, 800														
No. of Poles	(Pole)	2, 3, 4	2, 3, 4	2, 3, 4	2, 3, 4	2, 3, 4	2, 3, 4	2, 3, 4	2, 3, 4														
Rating (DC)	1000V	4P		4P	4P	4P	4P	4P	4P														
	750V	3P 3P		3P	3P	3P	3P	3P	3P														
	500V	2P		2P	2P	2P	2P	2P	2P														
Rated service breaking (DC)	Type	N	H	L	N	H	L	N	H	L	N	H	L	N	H	L	N	H	L	N	H	L	
	1000V (4P)	42	65	100	42	65	100	50	85	100	50	85	100	50	85	100	50	85	100	50	85	100	
	750V (3P)	42	65	100	42	65	100	50	85	100	50	85	100	50	85	100	50	85	100	50	85	100	
	500V (2P)	42	65	100	42	65	100	50	85	100	50	85	100	50	85	100	50	85	100	50	85	100	
Trip unit																							
	FTU (fixed-thermal, fixed-magnetic)	●	●	●	●	●	●	●	●	●	●	●	●	●	●	●	●	●	●	●	●	●	●
	FMU (adjustable-thermal, fixed-magnetic)	●	●	●	●	●	●	●	●	●	●	●	●	●	●	●	●	●	●	●	●	●	●
ATU (adjustable-thermal, adjustable-magnetic)	--	-	-	-	-	--	-	●	●	●	●	●	●	●	●	●	●	●	●	●	●	●	

Exemplary circuit diagrams

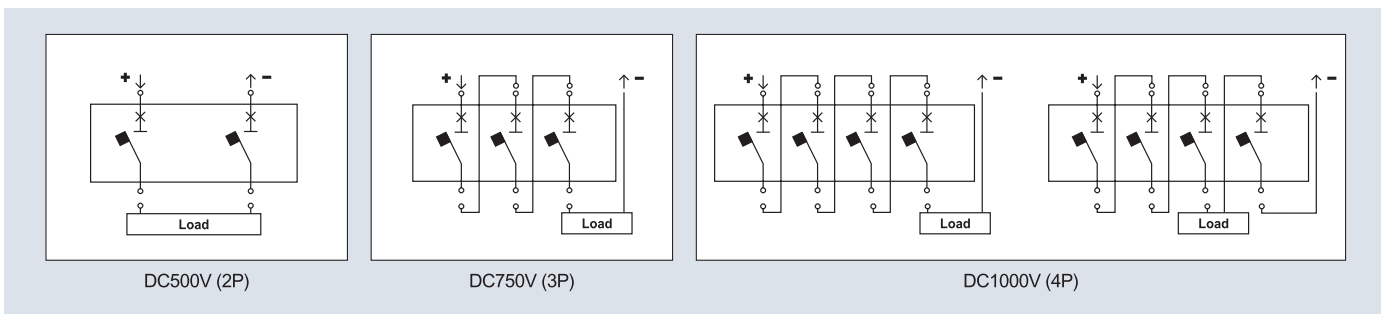



MCCB for DC Application

MCCB PV up to 800A

Warnings when using Susol MCCB on PV system

The following warning must be kept when using Susol MCCB on PV system
If not, it can result damages on any related products or injuries.



Warning

1. Please, follow the wiring as shown below.

When wired differently, usable voltage can be limited.

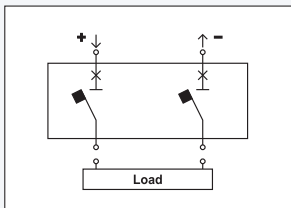

DC500V (2P)

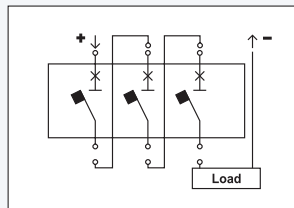

DC750V (3P)

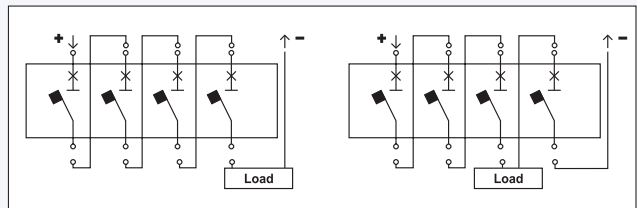

DC1000V (4P)

2. Use minimum of 60cm wire when wiring. Shot wires can result increasing temperature.

3. When designing circuit by using busbar as picture on right, de-rated use is recommended.

It can cause temperature increase, wrongly trip, damage or fire due to shortage of heat release(Refer to De-rating table)

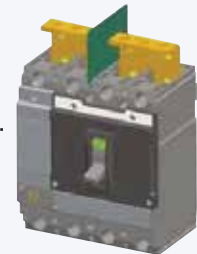

4. Please, maintain given thickness and length of busbar on the specification drawing.

Additional de-rating is required in order to release the heat when busbar specification is different than instructed.

5. It is recommended to use tin or silver plated busbar.

6. Install sun screens or fans to maintain KS or IEC standard 40°C inside of connection and low voltage panels.

When inside temperature of panel exceeds 40°C, it can cause temperature increase, wrongly trip, damage or fire.

Additional de-rating is required when panel temperature exceeds 40°C.

7. Please, ask any other further questions before applying.



MCCB for DC Application

MCCB PV up to 800A

Short Busbar Installation

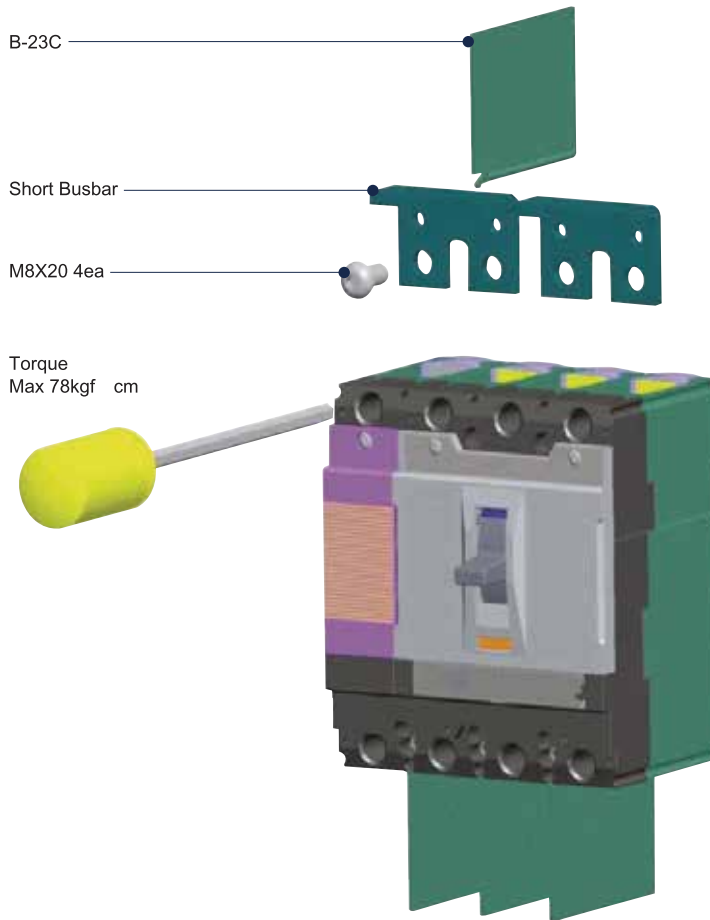

Configuration and Series Connection

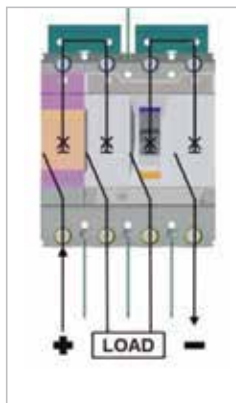

TD160

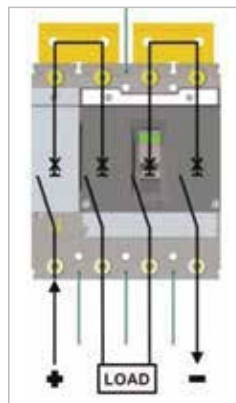

TS250

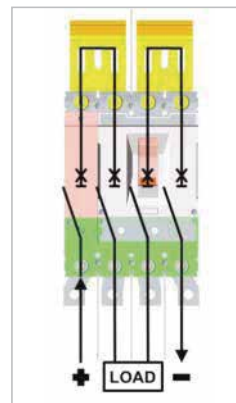

TS630

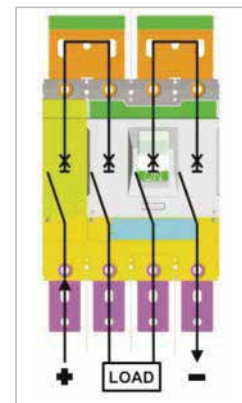

TS800



MCCB for DC Application

MCCB PV up to 800A

Derating Table for AF

The following tables are based on the following assumptions;

- Maximum permissible temperature of busbars are 100
- T : Temperature around the circuit breaker and its connections

Note) 1. The values presented in the tables are the result of trials and theoretical calculations on the basis of the assumption mentioned above.

2. These tables are intended as an aid in designing connection, however, the actual values must be confirmed by tests on the installation.

AF	Rated current(A)	Derating(A)	Short Busbar
TD100	16	16	TD160 3t Short Busbar
	20	20	
	25	25	
	32	32	
	40	40	TD160 4t Short Busbar
	50	50	
	63	63	
	80	80	
TD160	100	100	TD160 5t Short Busbar
	125	125	
	160	135	
TS100	40	40	TS250 4t Short Busbar
	50	50	
	63	63	
	80	80	
	100	100	
TS160	100	100	TS250 5t Short Busbar
	125	125	
	160	135	
TS250	125	125	TS800 Lower & Upper Short Busbar
	160	160	
	200	180	
	250	180	
TS400	300	300	TS800 Lower & Upper Short Busbar
	400	400	
TS630	500	500	
	630	500	
TS800	700 *	700	
	800	700	

Note) 1. * Only available for TS800FTU
2. Dimension on the short busbar refer to A-6-47~52.
3. Short busbar for PV application is not provided by LSIS.



MCCB for DC Application

MCCB PV up to 800A

Temperature Derating

Item	Rated current	Derating Current	Compensated rated current in accordance with ambient temperature (A)								Short Busbar	
			10	20	30	40	45	50	60	70		
TD100	16	16	16	16	16	16	16	15	14	13	TD160 3t Short Busbar	
	20	20	20	20	20	20	19	19	18	18		
	25	25	25	25	25	25	24	23	22	21		
	32	32	32	32	32	32	31	30	28	26		
	40	40	40	40	40	40	39	38	35	33		
	50	50	50	50	50	50	48	47	44	41		
	63	63	63	63	63	63	61	59	56	52		
	80	80	80	80	80	80	78	75	71	66		
	100	100	100	100	100	100	97	94	88	82		TD160 4t Short Busbar
TD160	100	100	100	100	100	100	97	94	88	82		
	125	125	125	125	125	125	121	117	110	103	TD160 5t Short Busbar	
	160	135	135	135	135	135	130	125	117	108		
TS100	40	40	40	40	40	40	39	38	35	33	TS250 4t Short Busbar	
	50	50	50	50	50	50	48	47	44	41		
	63	63	63	63	63	63	61	59	56	52		
	80	80	80	80	80	80	78	75	71	66		
	100	100	100	100	100	100	97	94	88	82		
TS160	100	100	100	100	100	100	97	94	88	82		
	125	125	125	125	125	125	121	117	110	103		
	160	160	160	160	160	160	155	150	141	131		TS250 5t Short Busbar
TS250	125	125	125	125	125	125	121	117	110	103		
	160	160	160	160	160	160	155	150	141	131		
	200	180	180	180	180	180	174	168	157	146		
	250	180	180	180	180	180	174	168	157	146		
TS400	300	300	300	300	300	300	291	281	264	246	TS630 Lower & Upper Short Busbar	
	400	400	400	400	400	400	388	375	353	323		
TS630	500	500	500	500	500	500	484	468	439	408		
	630	500	500	500	500	500	484	468	439	408		
TS800	700 *	700	700	700	700	700	678	656	616	573	TS800 Lower & Upper Short Busbar	
	800	700	700	700	700	700	678	656	616	573		

Note) * Only available for TS800FTU



4 pole MCCB with electronic trip unit

Products application & Function

- N-R-S-T and R-S-T-N Type for consideration of application field
- Full line up with 100~800AF
- 4P4D for N phase protection type
- Max. breaking capacity 150kA@415V
- KEMA type test and CE certification



Designation	TS100, TS160, TS250			TS400, TS630			TS800			
Type	N / H / L			N / H / L			N / H / L			
Rated current	40, 80, 160, 250A			160, 250, 400, 630A			630, 800A			
Poles	4 (N-R-S-T, R-S-T-N)			4 (N-R-S-T, R-S-T-N)			4 (N-R-S-T, R-S-T-N)			
Insulation voltage, Ui	AC750V			AC750V			AC750V			
Impulse withstand voltage, Uimp	8kV			8kV			8kV			
Short-circuit breaking capacity, Icu	N	H	L	N	H	L	N	H	L	
AC 50/60Hz	220/240V	100	120	200	100	120	200	100	120	200
	380/415V	50	85	150	50	85	150	50	85	150
	440/460V	50	70	130	50	70	130	50	70	130
	480/500V	42	65	85	42	65	85	42	65	85
	660/690V	10	15	20	10	15	20	10	15	20
Ics	100% Icu			100% Icu			100% Icu			
Utilization category	A			A			A			
Reverse connection (Line/Load)	Available			Available			Available			
Tripping device	Electronics			Electronics			Electronics			
	ETS			ETS & ETM			ETS & ETM			
Thermal	ETS: Ir = 0.4~1.0 In (13settings)			ETS: Ir = 0.4~1.0 In (13settings)			ETS: Ir = 0.4~1.0 In (13settings)			
Io, Ir	ETS: Ir = 0.4~1.0 In (13settings)			ETM: Io = 0.5~1.0 In (6settings) Ir = 0.8~1.0 Io (5settings)			ETM: Io = 0.5~1.0 In (6settings) Ir = 0.8~1.0 Io (5settings)			
tr (6Ir)	ETS: 6sec at 6Ir (fixed)			ETS: 6sec at 6Ir (fixed)			ETS: 6sec at 6Ir (fixed)			
				ETM: 12sec at 6Ir (5settings)			ETM: 12sec at 6Ir (5settings)			
Instant.	Im	ETS: 1.5~10 Ir (9settings)			ETS, ETM: 1.5~10 Ir (9settings)			ETS, ETM: 1.5~10 Ir (9settings)		
	It 12	In			12 In			12 In		
Neutral protection	4P3d	No protection			No protection			No protection		
	4P3d+N/2	0.5 Ir			0.5 Ir			0.5 Ir		
	4P4d	1.0 Ir			1.0 Ir			1.0 Ir		
Cable	Min	10mm ² or 8 AWG(40A)			70mm ² (160A)			185mm ² 2 / 350 kcmil 2(630A)		
	Max	120mm ² or 250kcmil(250A)			185mm ² 2 / 350 kcmil 2(630A)			240mm ² 2(800A)		
Tightening Torque		Hex.Socket bolt (M8): 6N.m			Hex.Socket bolt (M10): 10N.m			Hex. Socket bolt (M12): 14N.m		
MCCB (W H D)		140 160 86			186.5 260 110			280 320 135		

* Breaking capacity at 660/690V is for your reference. (not certified)

Characteristics curves

Circuit breakers with thermal-magnetic trip units

TE100
FTU
FMU
16~100A

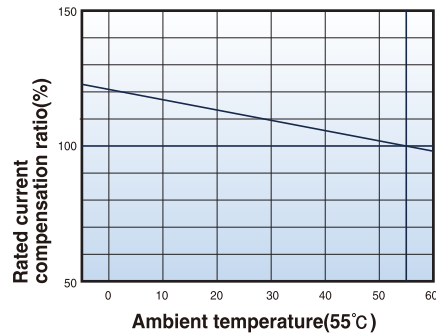
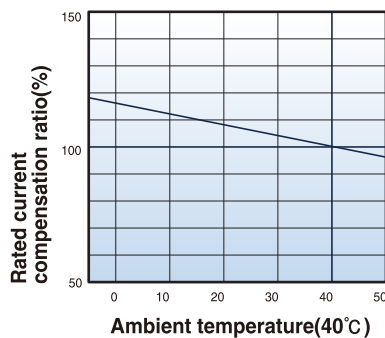
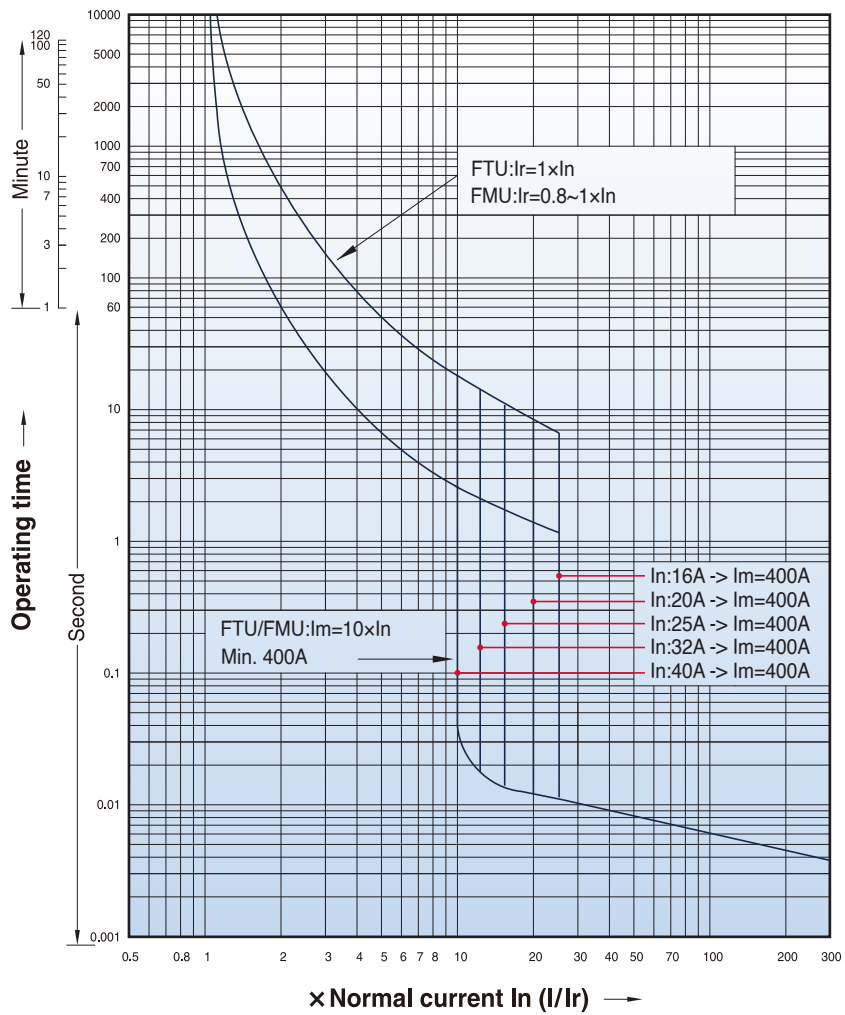



Characteristics curves

Circuit breakers with thermal-magnetic trip units

TE160
FTU
FMU
100~160A

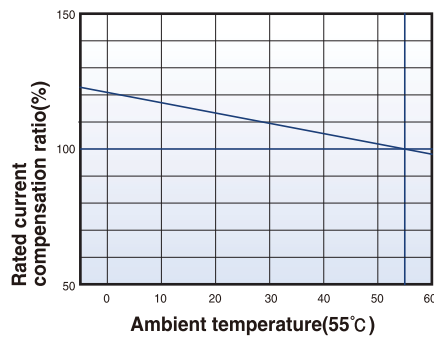
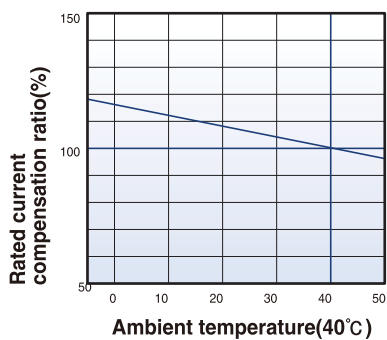
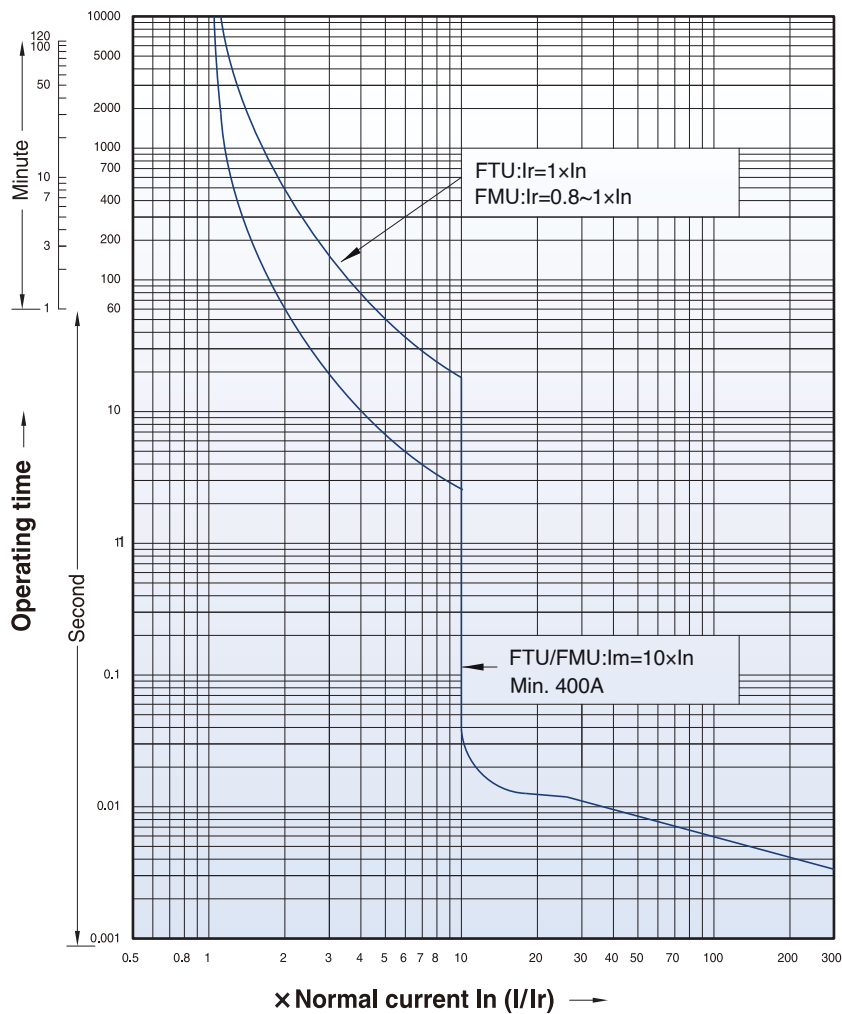

Characteristics curves

Circuit breakers with thermal-magnetic trip units

TD100
FTU
FMU
16~100A

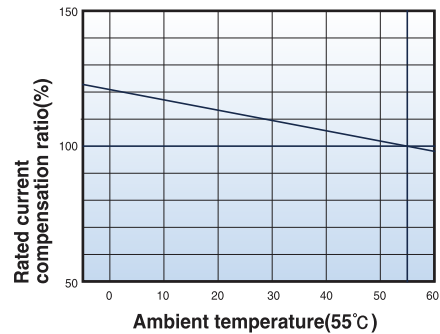
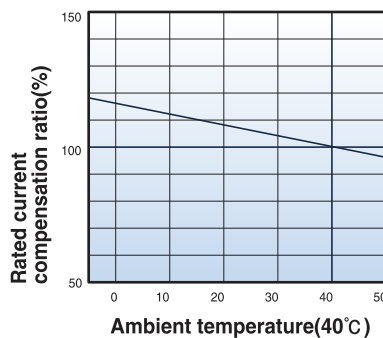
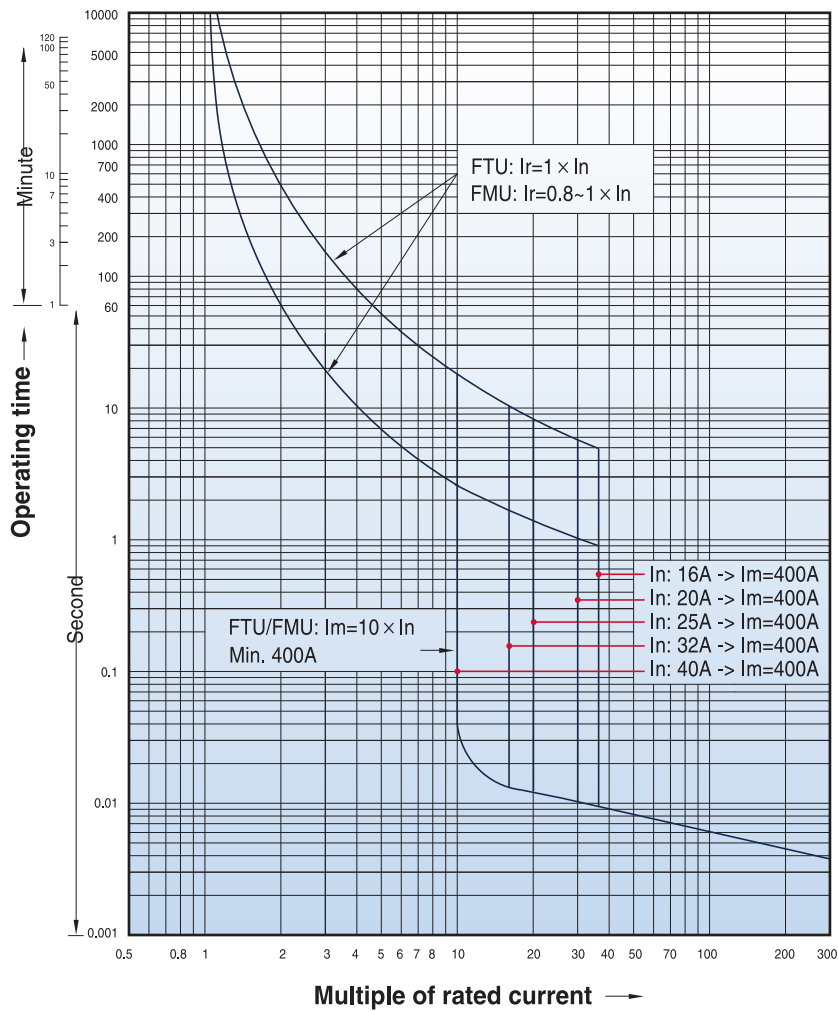

Characteristics curves

Circuit breakers with thermal-magnetic trip units

TD160
FTU
FMU
100~160A

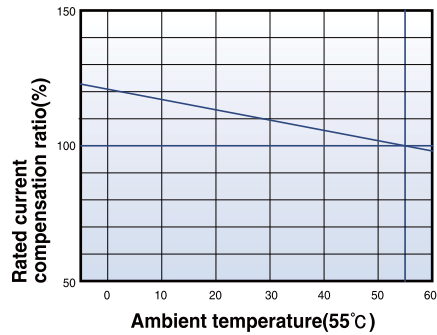
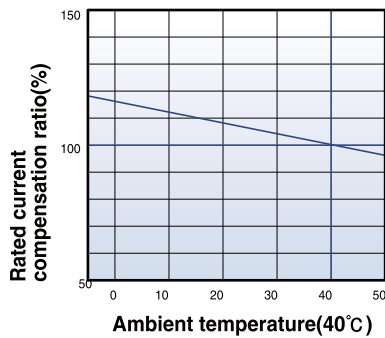
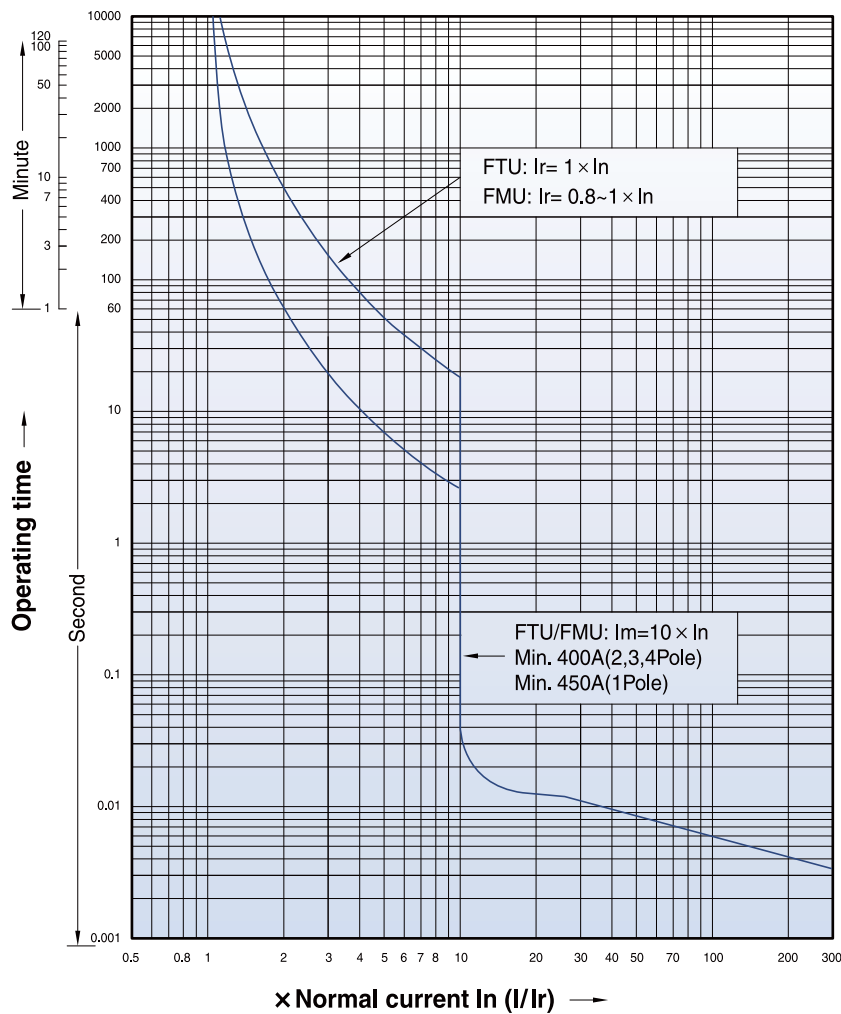



Characteristics curves

Circuit breakers with thermal-magnetic trip units

TS100

FTU

FMU

40~100A

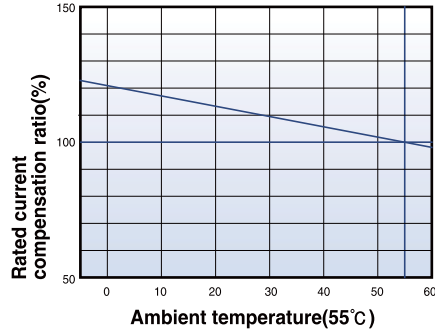
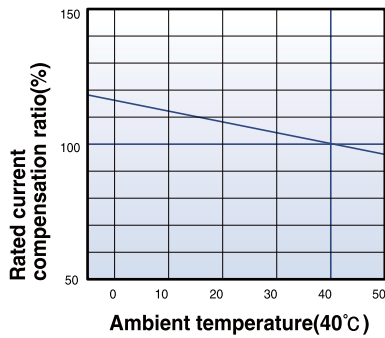
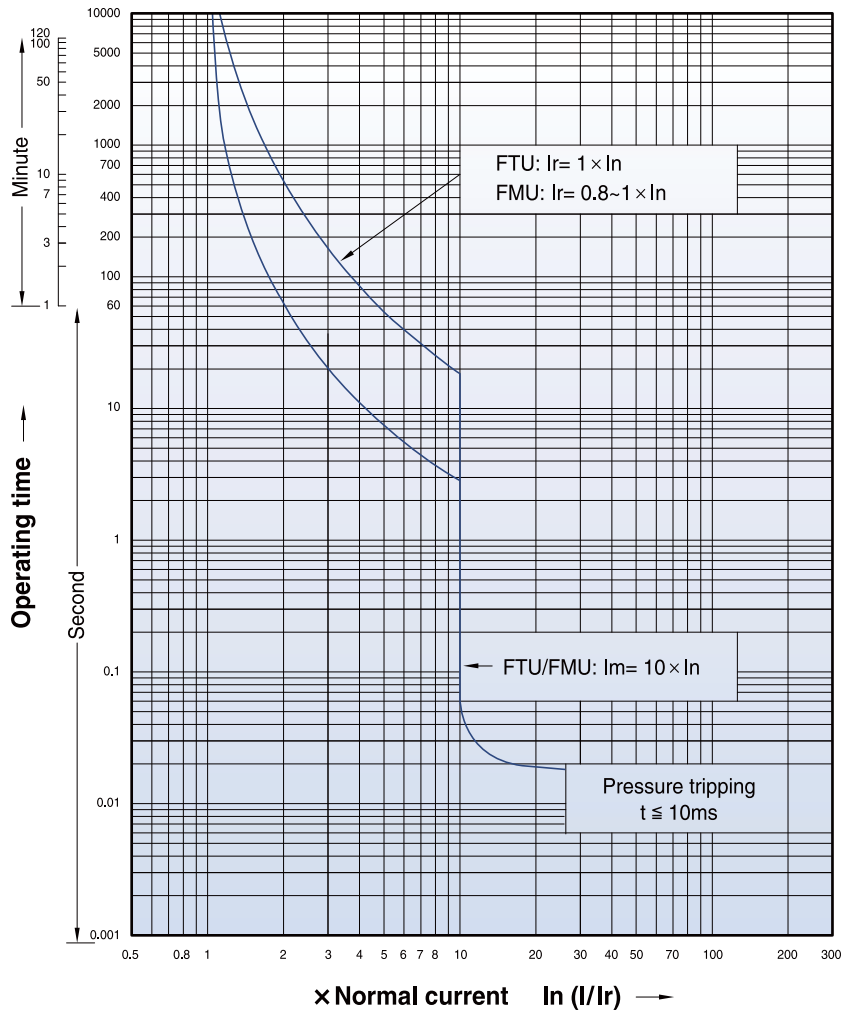



Characteristics curves

Circuit breakers with magnetic only trip units

TS100
Magnetic only
MTU
1.6~100A

TS160
Magnetic only
MTU
32~160A

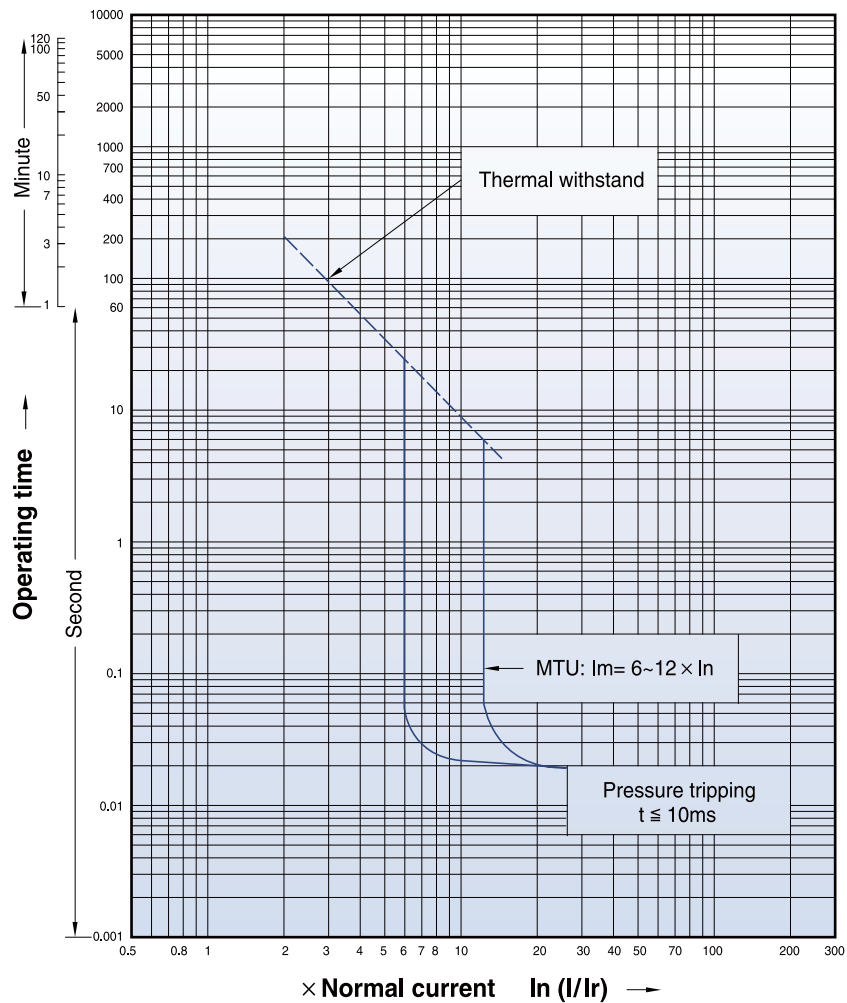

Magnetic trip units(MTU)

Rating(A)		In
N / H / L	TS100	1.6 ~ 100
	TS160	32 ~ 160
	TS250	250
	TS400	400
	TS630	630
	TS800	800

TS100 to TS800													
1.6	3.2	6.3	12	20	32	50	63	100	160	220	320	500	630
●	●	●	●	●	●	●	●	●	-	-	-	-	-
-	-	-	-	-	●	●	●	●	●	-	-	-	-
-	-	-	-	-	-	-	-	●	●	●	-	-	-
-	-	-	-	-	-	-	-	-	-	-	●	-	-
-	-	-	-	-	-	-	-	-	-	-	-	●	-
-	-	-	-	-	-	-	-	-	-	-	-	-	●

Short - circuit protection(magnetic)

Pick - up	Im
-----------	----

Setting
6..12 × In (6 Point)



Characteristics curves

Circuit breakers with thermal-magnetic trip units

TS160

FTU

FMU

100, 125, 160A

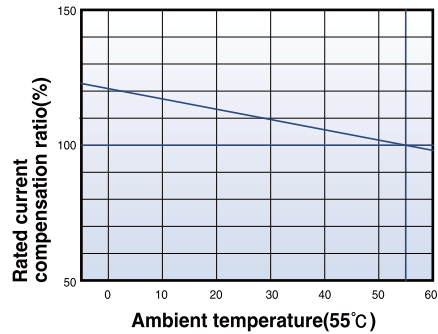
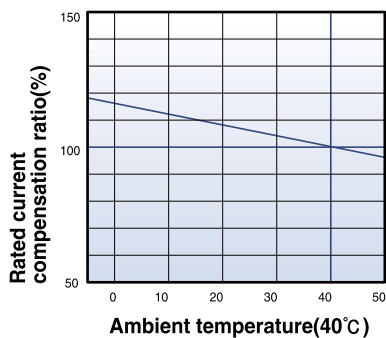
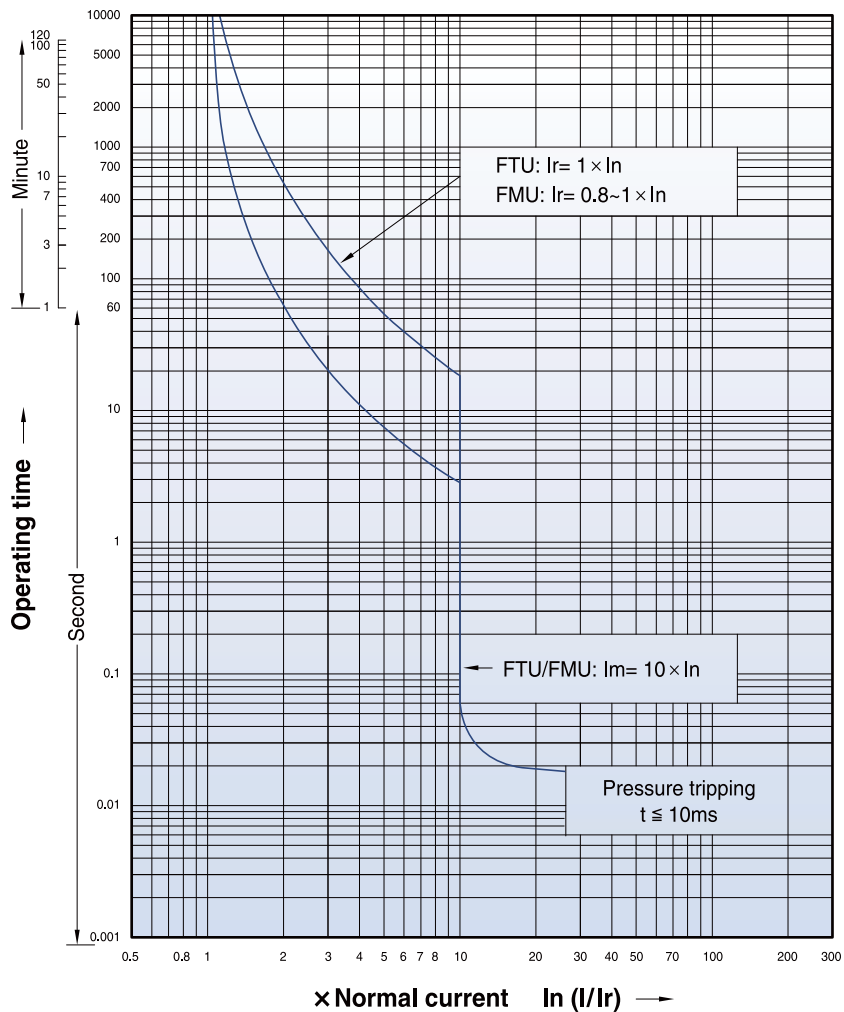



Characteristics curves

Circuit breakers with thermal-magnetic trip units

TS250
FTU
FMU
125~250A

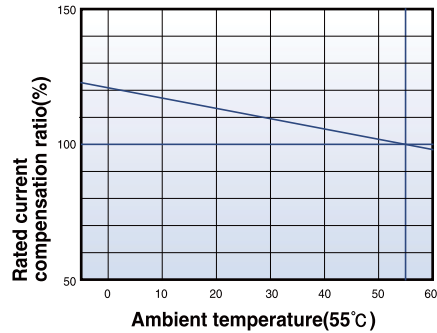
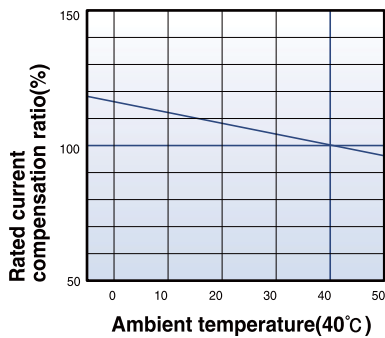
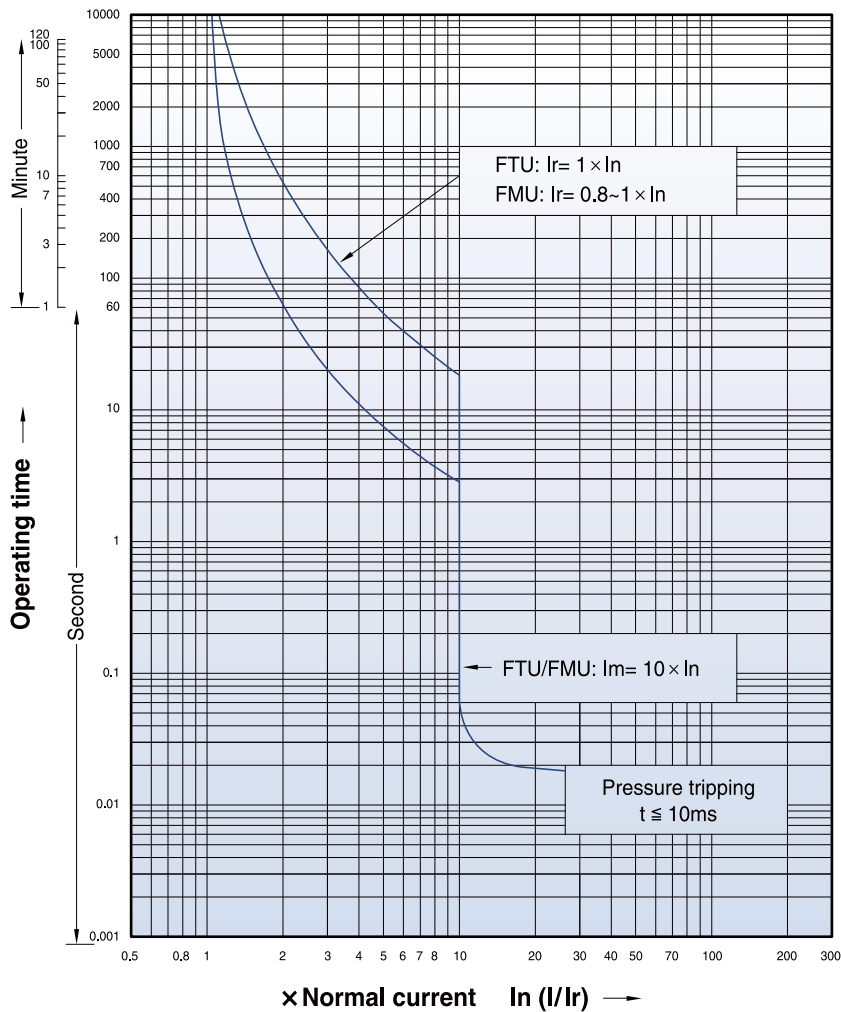



Characteristics curves

Circuit breakers with thermal-magnetic trip units

TS250
ATU
125~250A

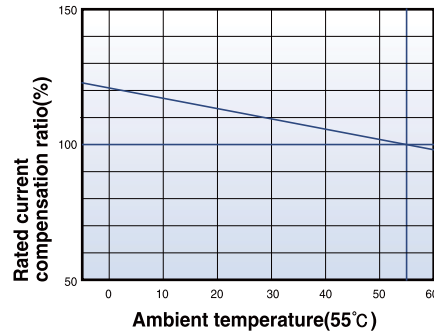
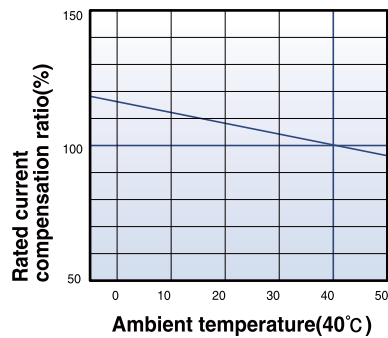
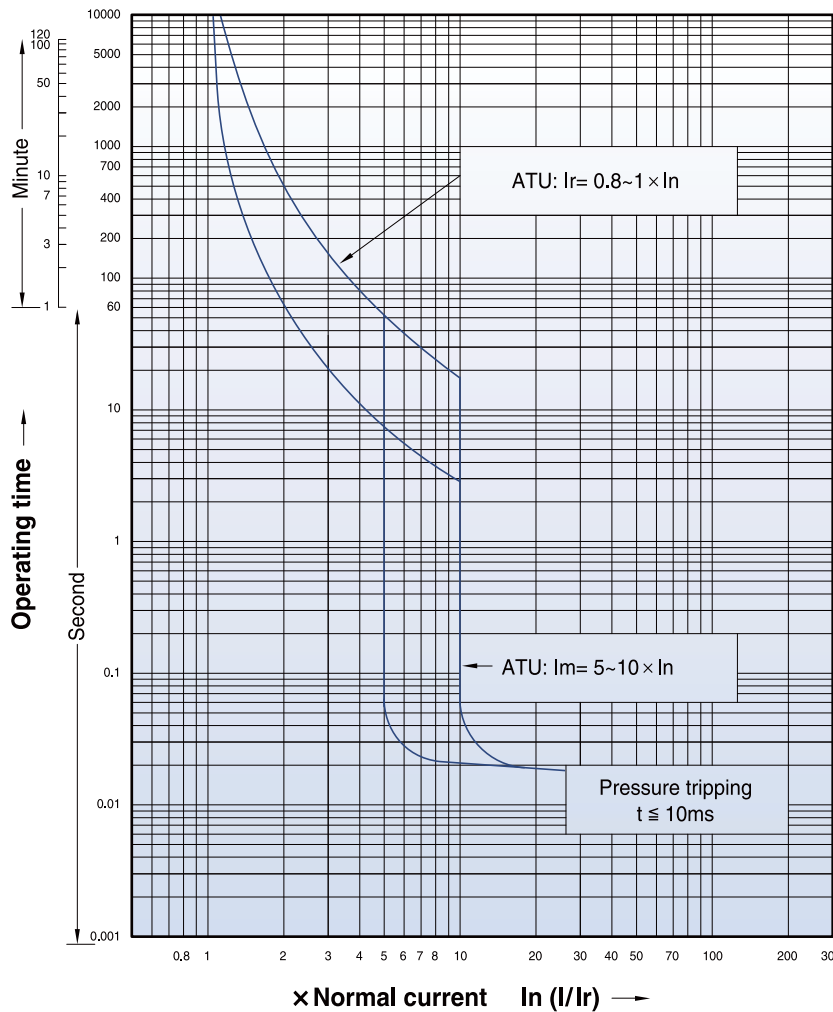



Characteristics curves

Circuit breakers with magnetic only trip units

TS250
Magnetic only
MTU
100, 160, 220A

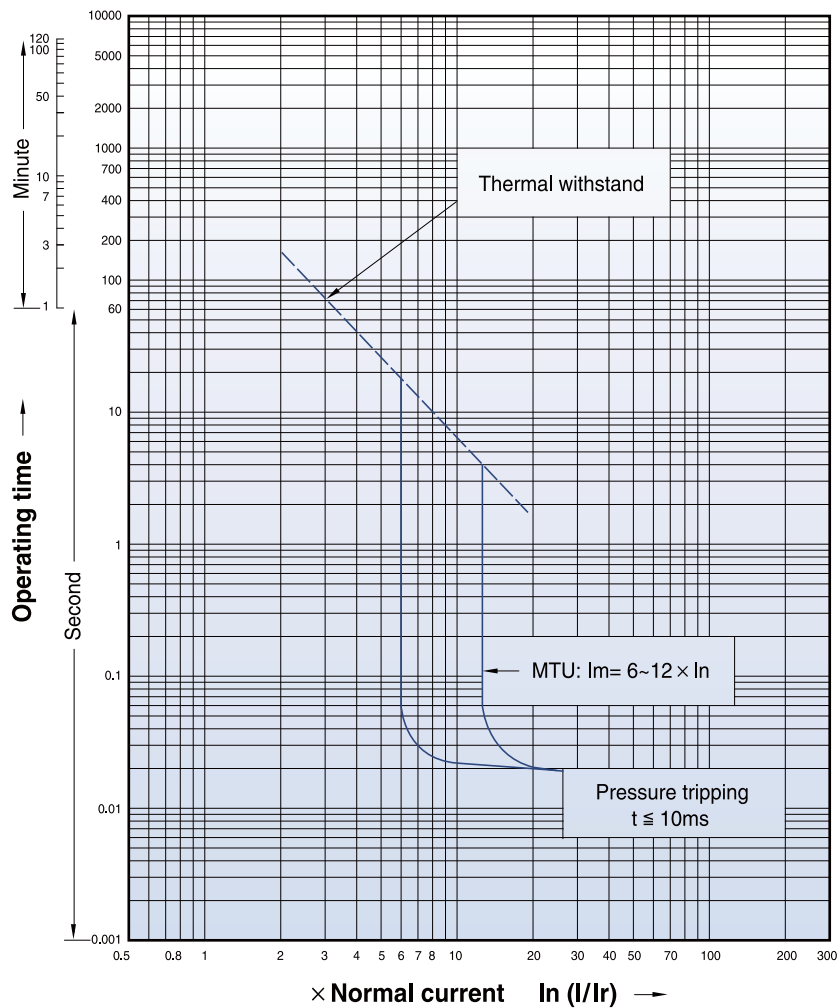

Magnetic trip units(MTU)

Rating(A)		In
N / H / L	TS100	
	TS160	
	TS250	
	TS400	
	TS630	
	TS800	

TS100 to TS800													
1.6	3.2	6.3	12	20	32	50	63	100	160	220	320	500	630
●	●	●	●	●	●	●	●	●	-	-	-	-	-
-	-	-	-	-	●	●	●	●	●	-	-	-	-
-	-	-	-	-	-	-	-	●	●	●	-	-	-
-	-	-	-	-	-	-	-	-	-	-	●	-	-
-	-	-	-	-	-	-	-	-	-	-	-	●	-
-	-	-	-	-	-	-	-	-	-	-	-	-	●

Short - circuit protection(magnetic)

Pick - up	Im
-----------	----

Setting
6..12 × In (6 Point)



Characteristics curves

Circuit breakers with thermal-magnetic trip units

TS400
FTU
FMU
300, 400A

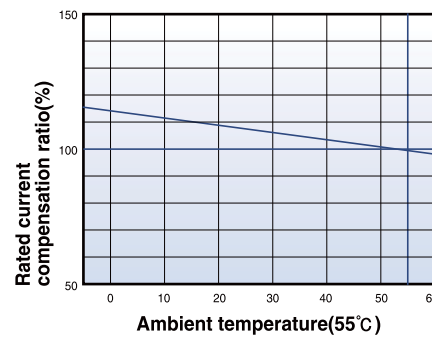
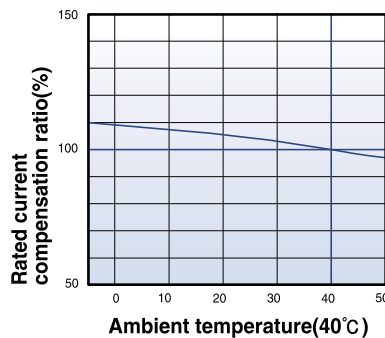
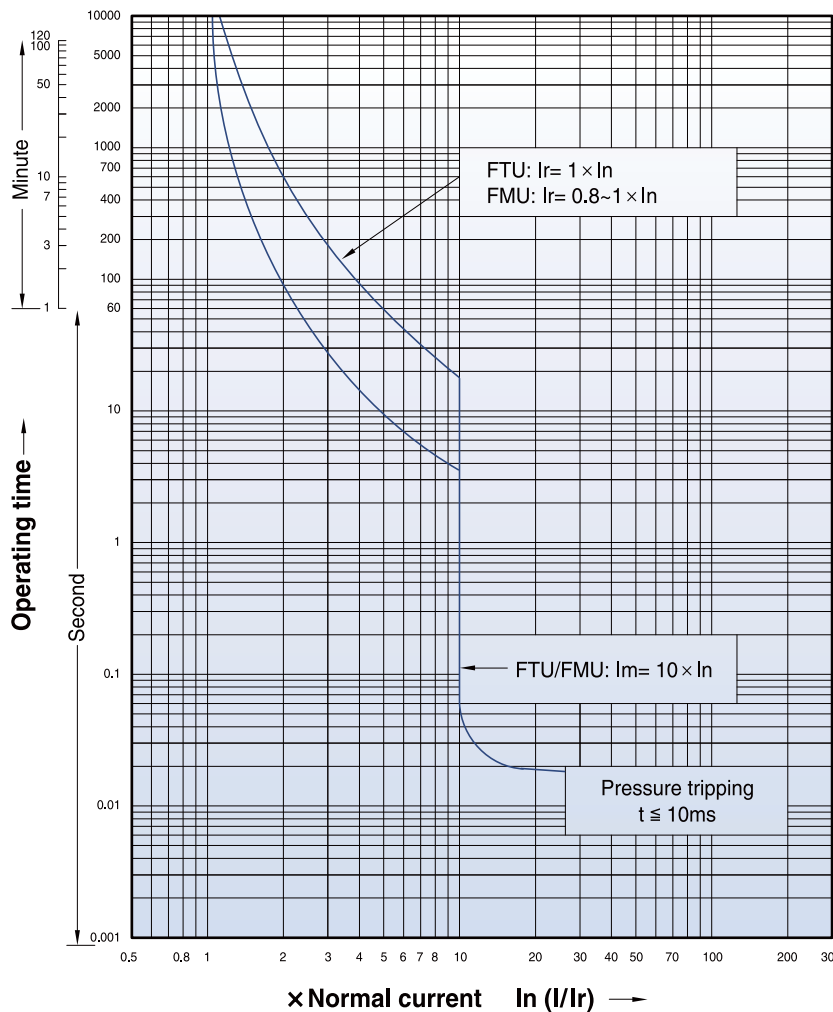

Characteristics curves

Circuit breakers with thermal-magnetic trip units

TS400
ATU
300, 400A

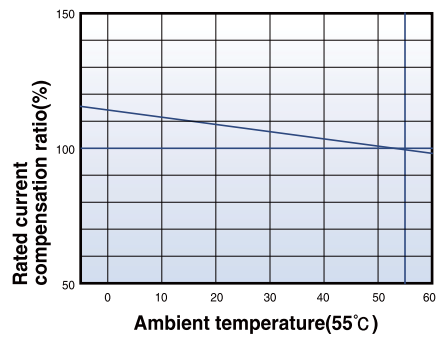
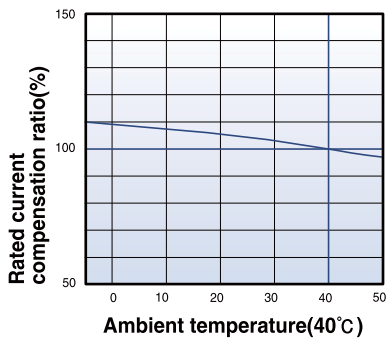
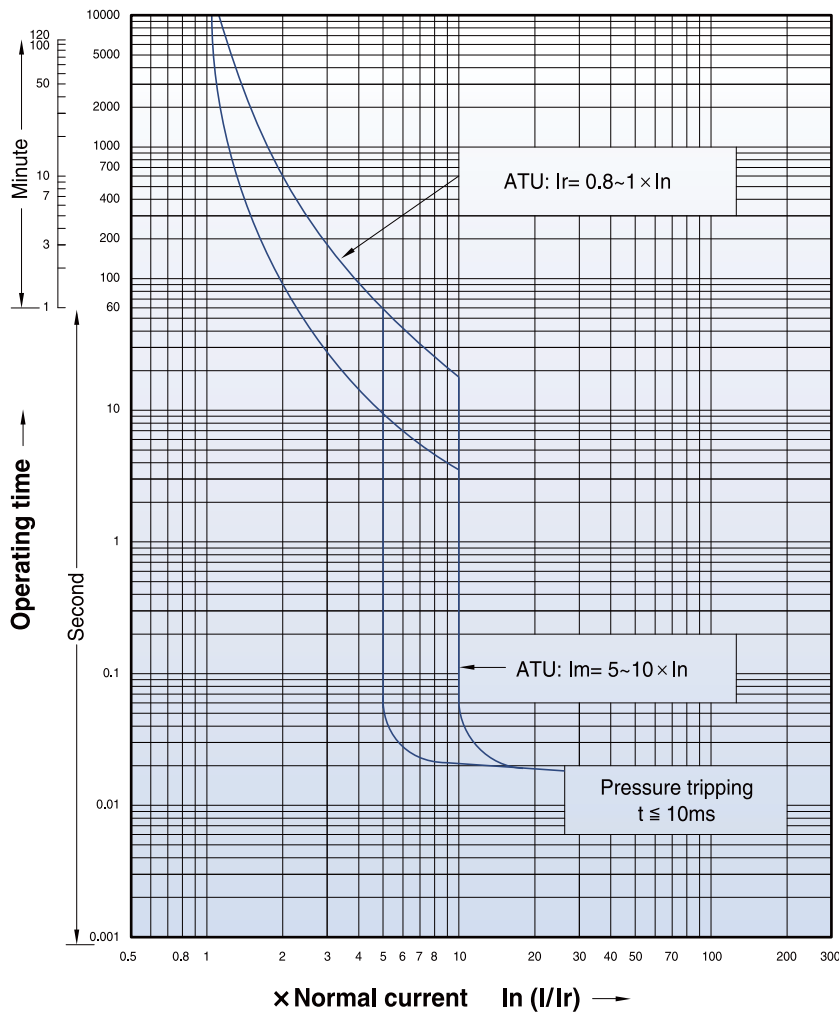



Characteristics curves

Circuit breakers with magnetic only trip units

TS400
MTU
320A

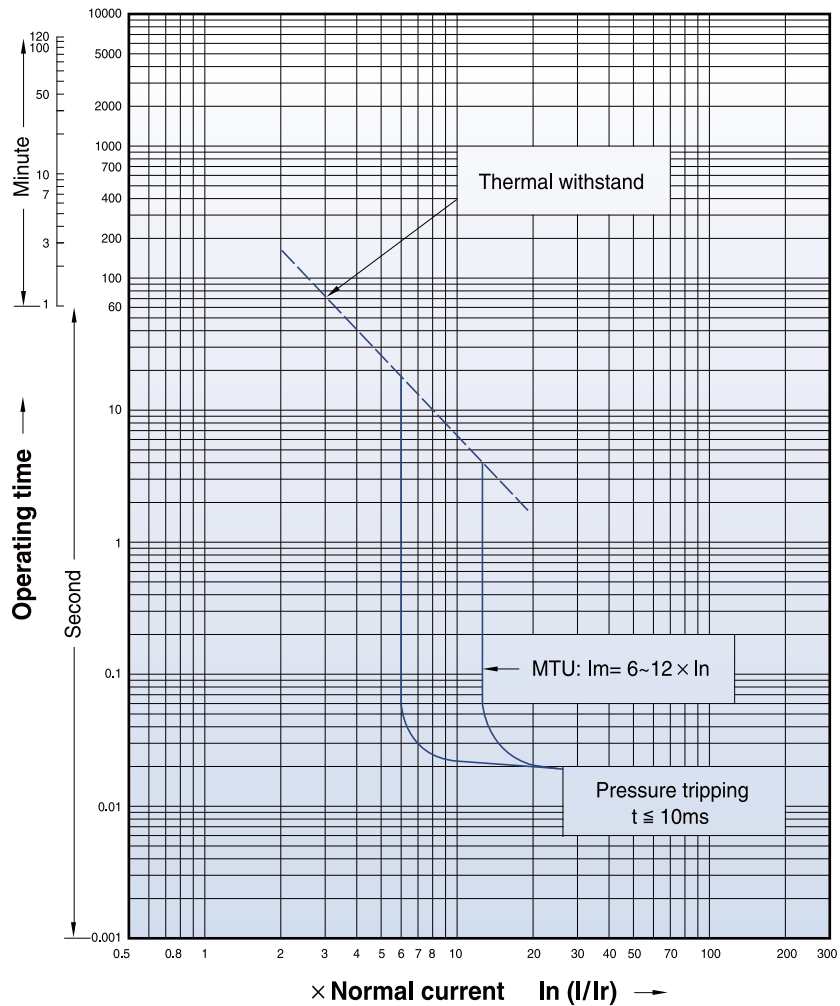

Magnetic trip units(MTU)

Rating(A)		I_n
N / H / L	TS100	
	TS160	
	TS250	
	TS400	
	TS630	
	TS800	

TS100 to TS800													
1.6	3.2	6.3	12	20	32	50	63	100	160	220	320	500	630
●	●	●	●	●	●	●	●	●	-	-	-	-	-
-	-	-	-	-	●	●	●	●	●	-	-	-	-
-	-	-	-	-	-	-	-	●	●	●	-	-	-
-	-	-	-	-	-	-	-	-	-	-	●	-	-
-	-	-	-	-	-	-	-	-	-	-	-	●	-
-	-	-	-	-	-	-	-	-	-	-	-	-	●

Short - circuit protection(magnetic)

Pick - up	I_m
-----------	-------

Setting
$6..12 \times I_n$ (6 Point)



Characteristics curves

Circuit breakers with thermal-magnetic trip units

TS630
FTU
FMU
500, 630A

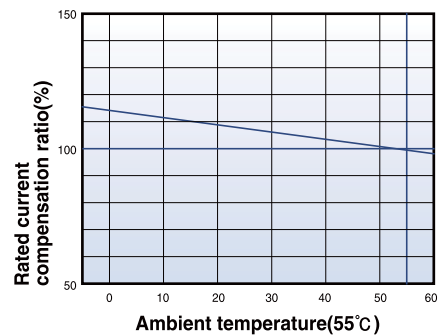
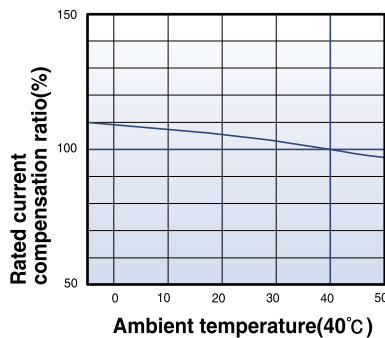
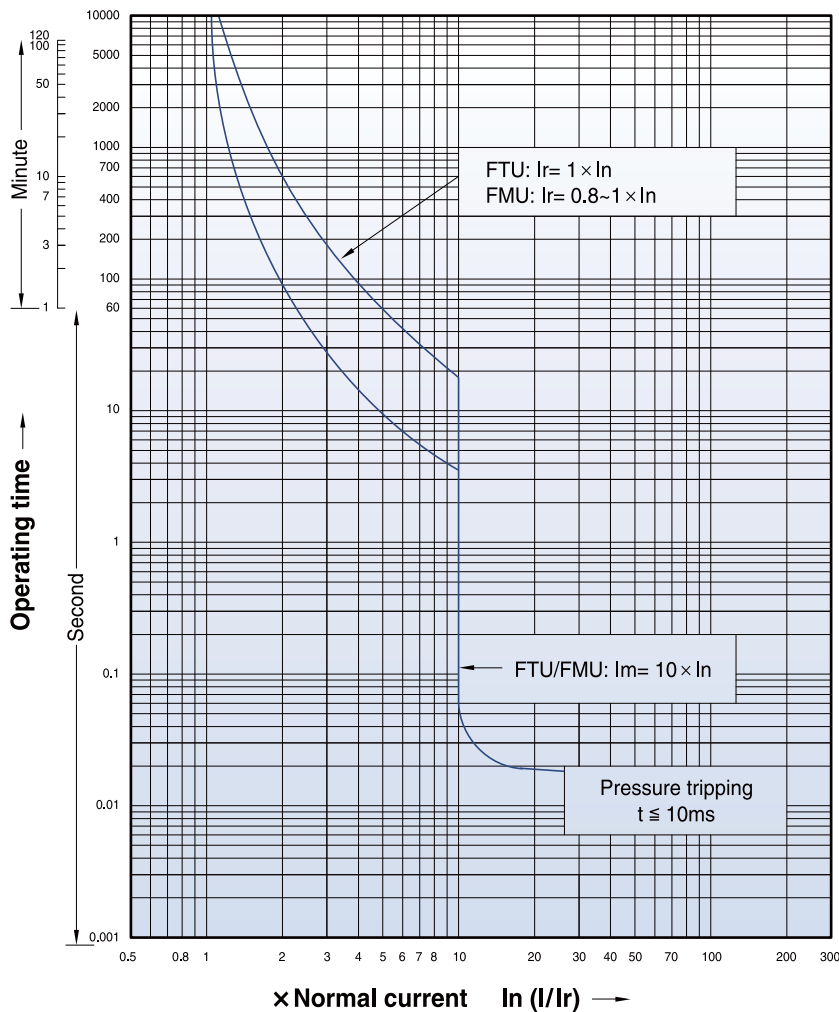



Characteristics curves

Circuit breakers with thermal-magnetic trip units

TS630
ATU
500, 630A

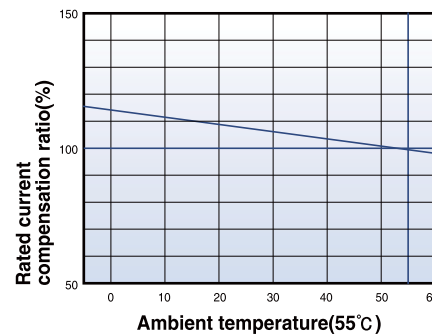
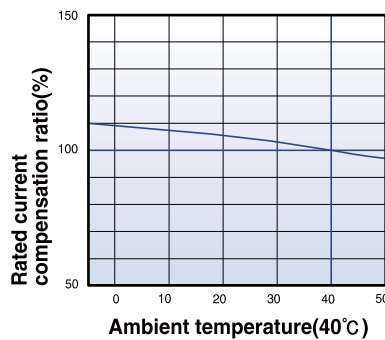
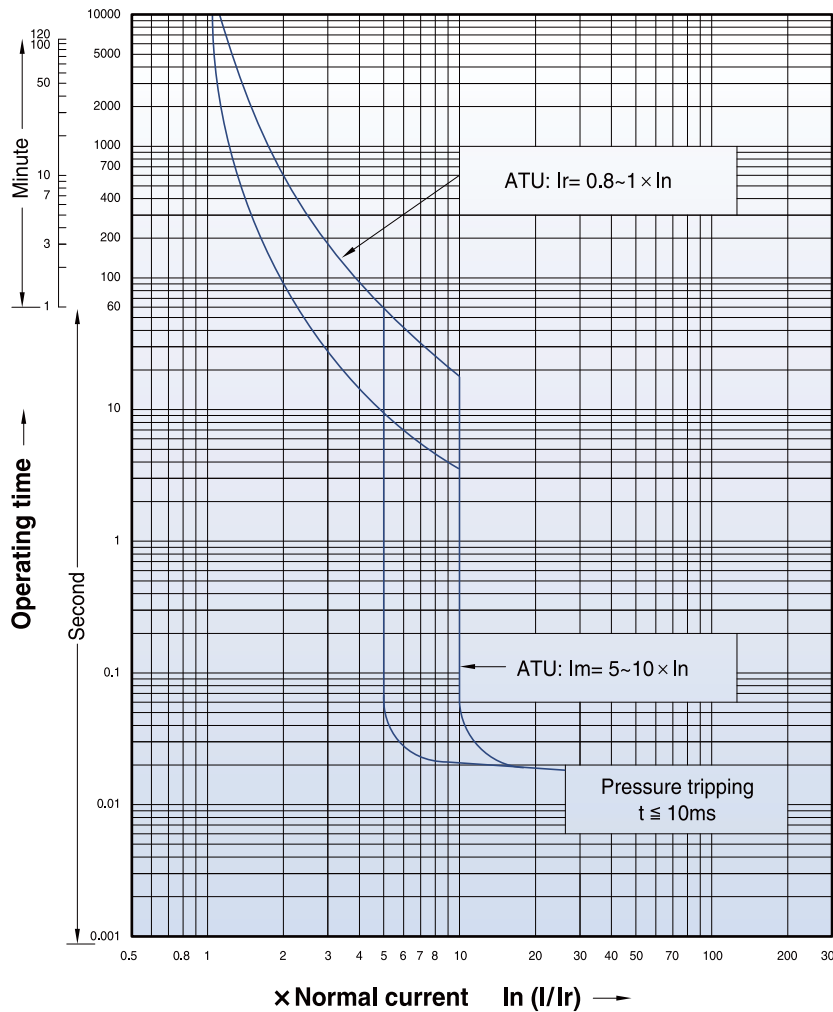



Characteristics curves

Circuit breakers with magnetic only trip units

TS630

MTU

500A

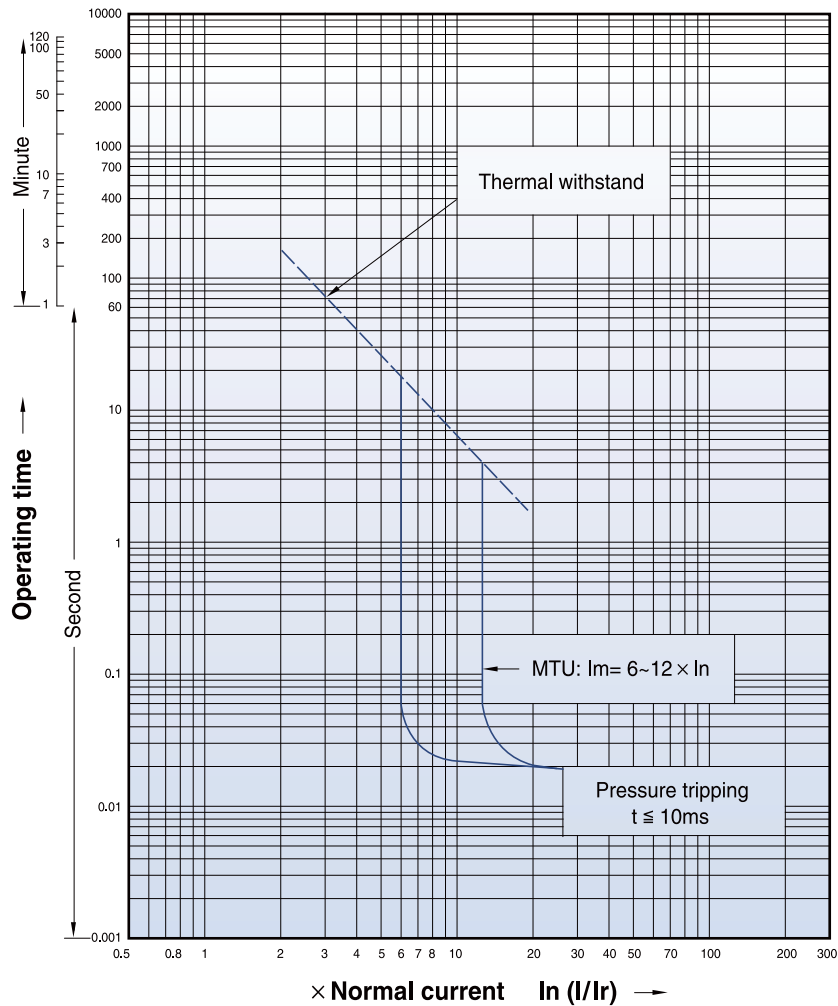

Magnetic trip units(MTU)

Rating(A)		I_n
N / H / L	TS100	
	TS160	
	TS250	
	TS400	
	TS630	
	TS800	

TS100 to TS800													
1.6	3.2	6.3	12	20	32	50	63	100	160	220	320	500	630
●	●	●	●	●	●	●	●	●	-	-	-	-	-
-	-	-	-	-	●	●	●	●	●	-	-	-	-
-	-	-	-	-	-	-	-	●	●	●	-	-	-
-	-	-	-	-	-	-	-	-	-	-	●	-	-
-	-	-	-	-	-	-	-	-	-	-	-	●	-
-	-	-	-	-	-	-	-	-	-	-	-	-	●

Short - circuit protection(magnetic)

Pick - up	I_m

Setting
$6..12 \times I_n$ (6 Point)

Characteristics curves

Circuit breakers with thermal-magnetic trip units

TS800
FTU
 700, 800A

FMU
 800A

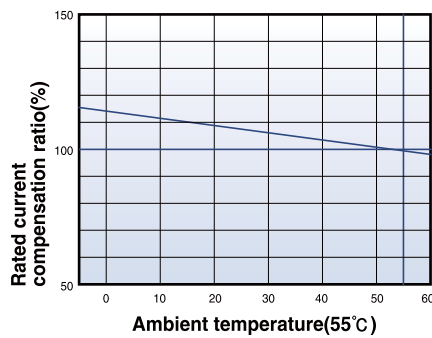
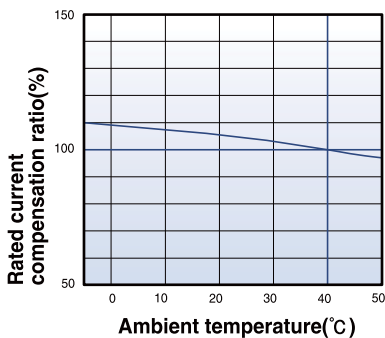
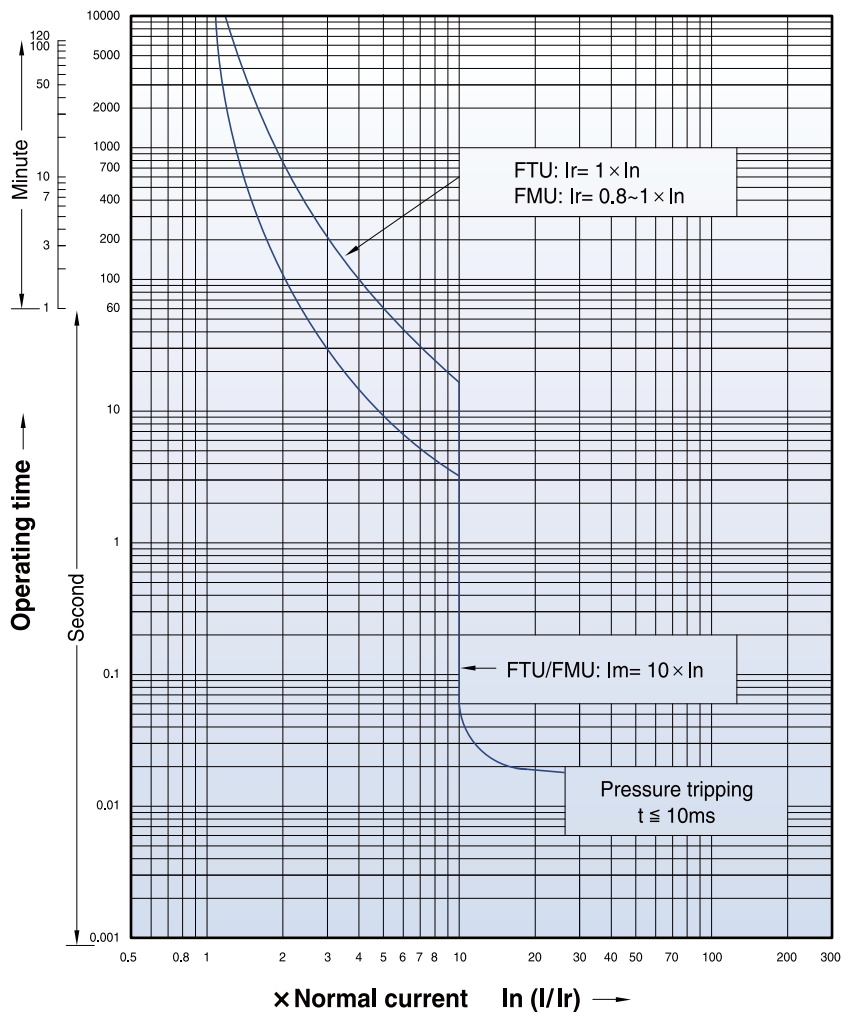



Characteristics curves

Circuit breakers with thermal-magnetic trip units

TS800
ATU
800A

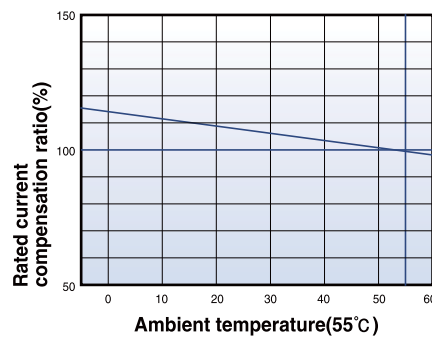
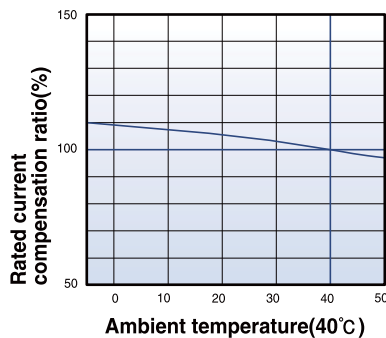
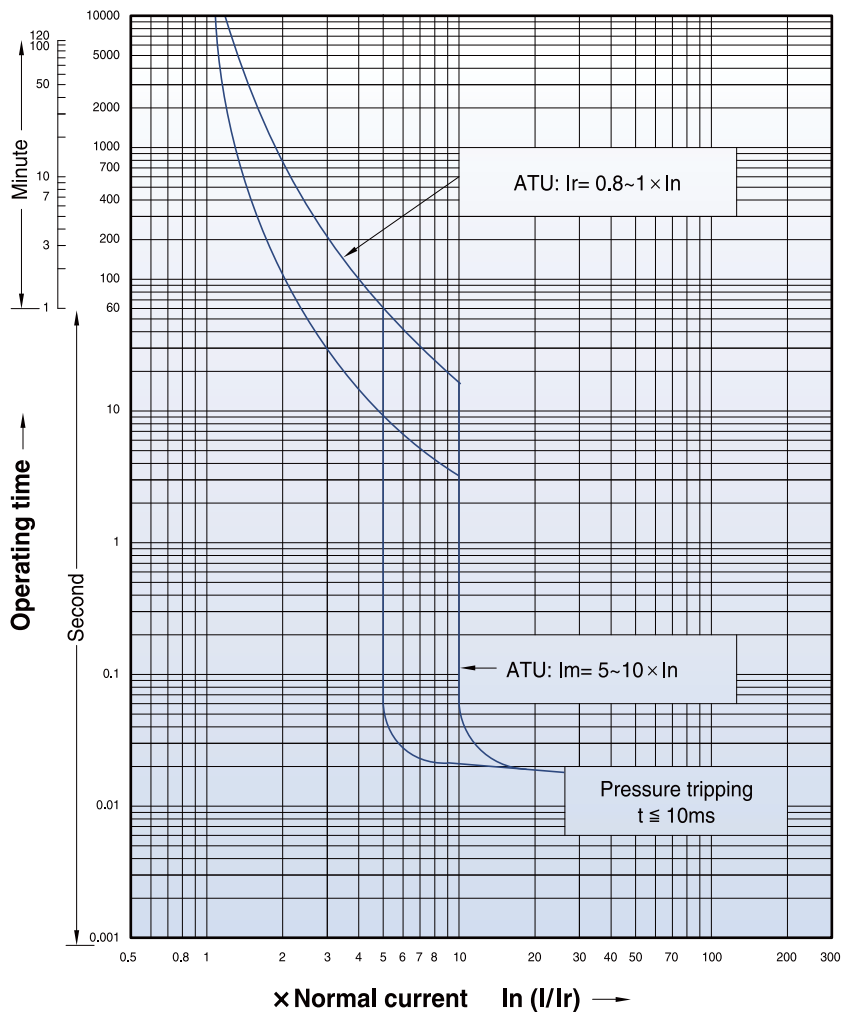



Characteristics curves

Circuit breakers with magnetic only trip units

TS800
MTU
630A

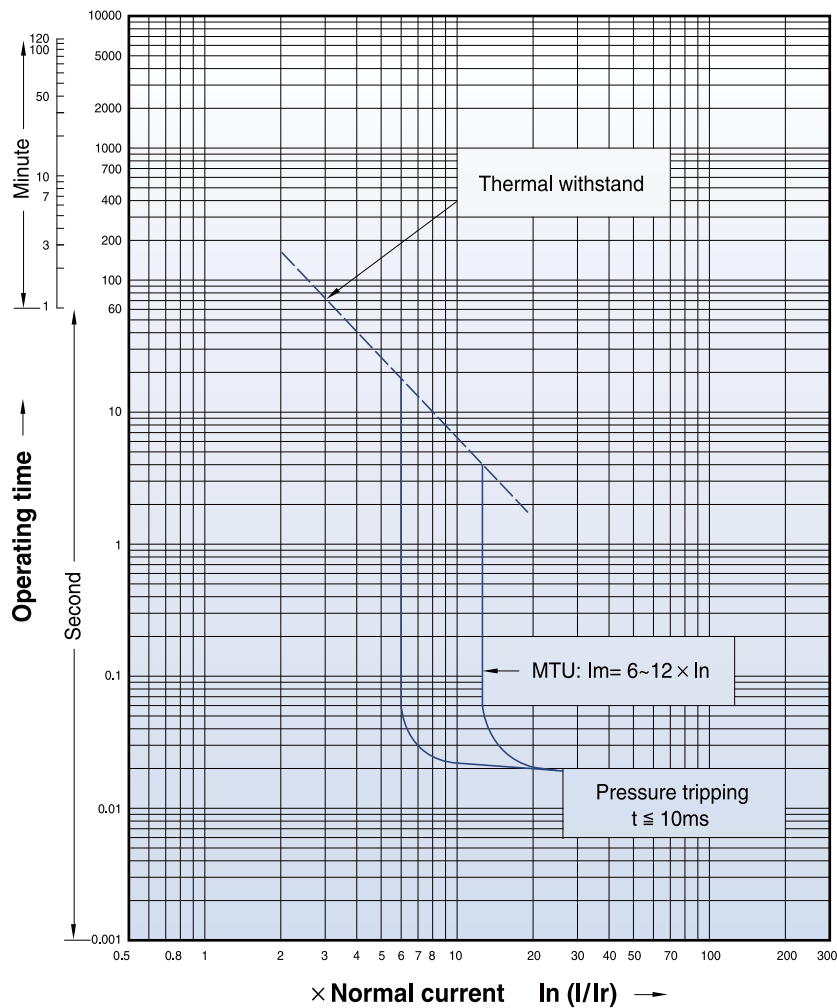

Magnetic trip units(MTU)

Rating(A)		I_n
N / H / L	TS100	
	TS160	
	TS250	
	TS400	
	TS630	
	TS800	

TS100 to TS800													
1.6	3.2	6.3	12	20	32	50	63	100	160	220	320	500	630
●	●	●	●	●	●	●	●	●	-	-	-	-	-
-	-	-	-	-	●	●	●	●	●	-	-	-	-
-	-	-	-	-	-	-	-	●	●	●	-	-	-
-	-	-	-	-	-	-	-	-	-	-	●	-	-
-	-	-	-	-	-	-	-	-	-	-	-	●	-
-	-	-	-	-	-	-	-	-	-	-	-	-	●

Short - circuit protection(magnetic)

Pick - up	I_m
-----------	-------

Setting
$6..12 \times I_n$ (6 Point)

Characteristics curves

Circuit breakers with electronic trip unit (ETS)

TS100 to TS800

ETS23

ETS33

ETS43

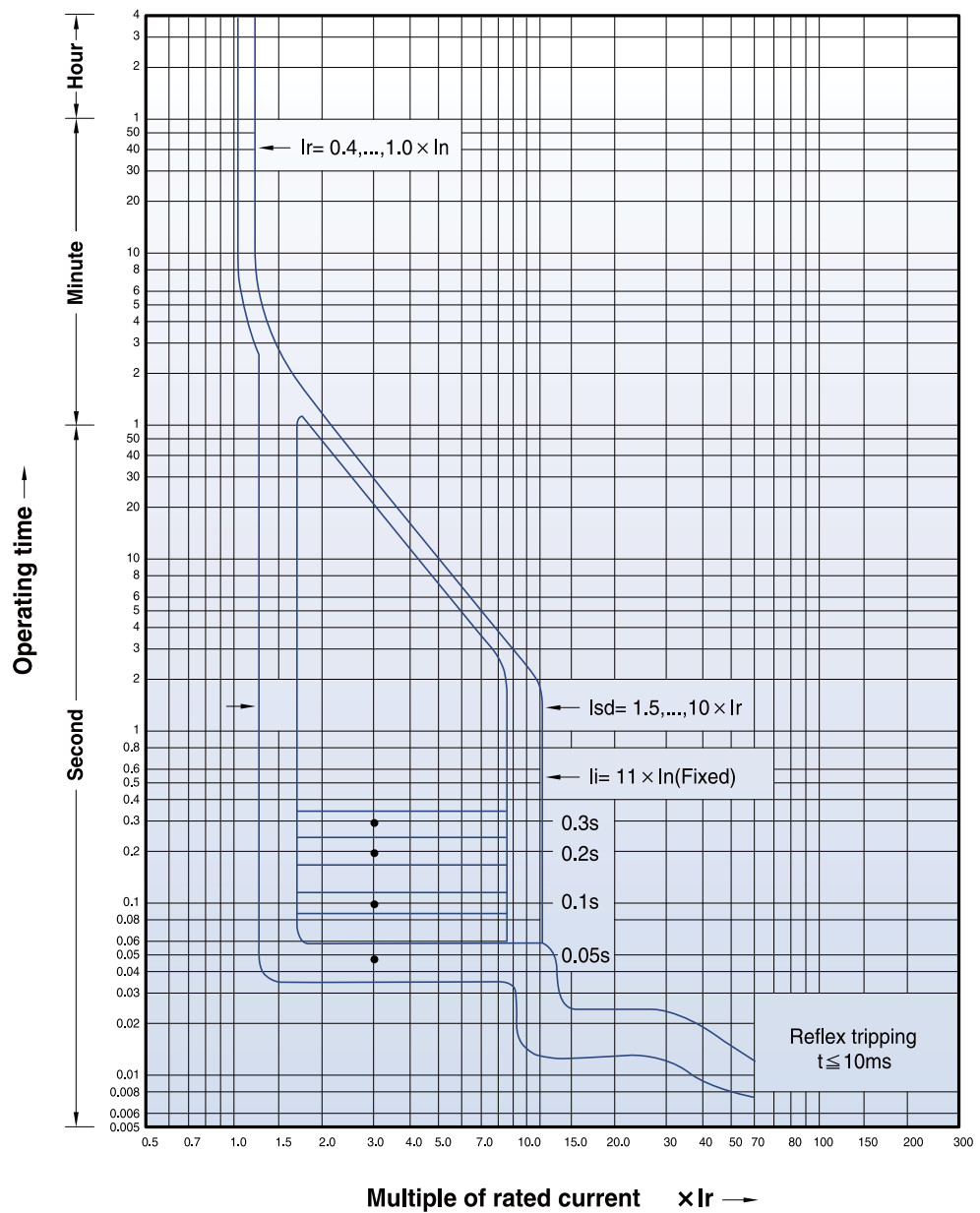

Characteristics curves

Circuit breakers with electronic trip unit (ETM)

TS400
TS630
TS800
ETM33
ETM43

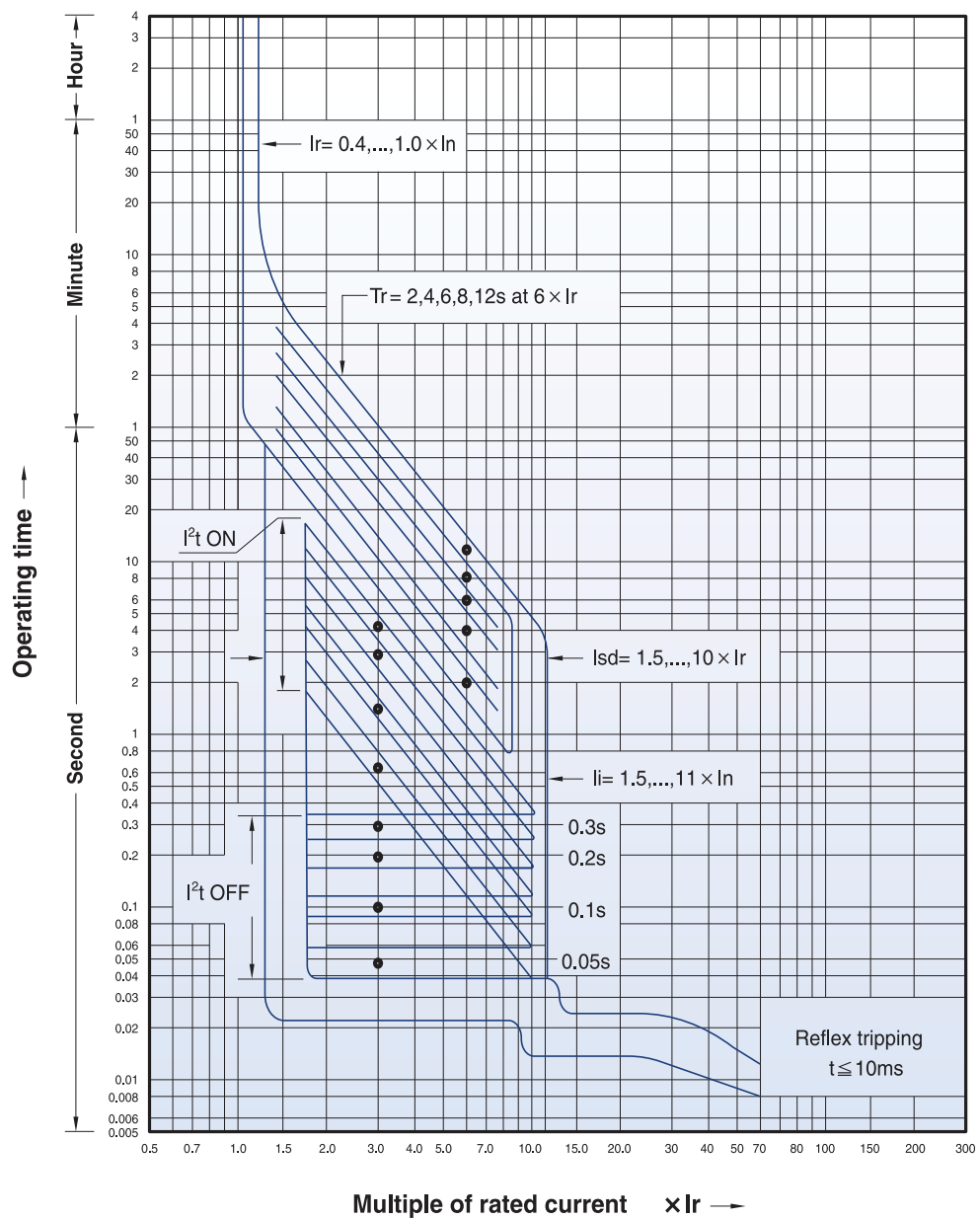

Overall dimensions (DC 1000V PV MCCB)

TD160

Dimension of MCCB with short BUSBAR

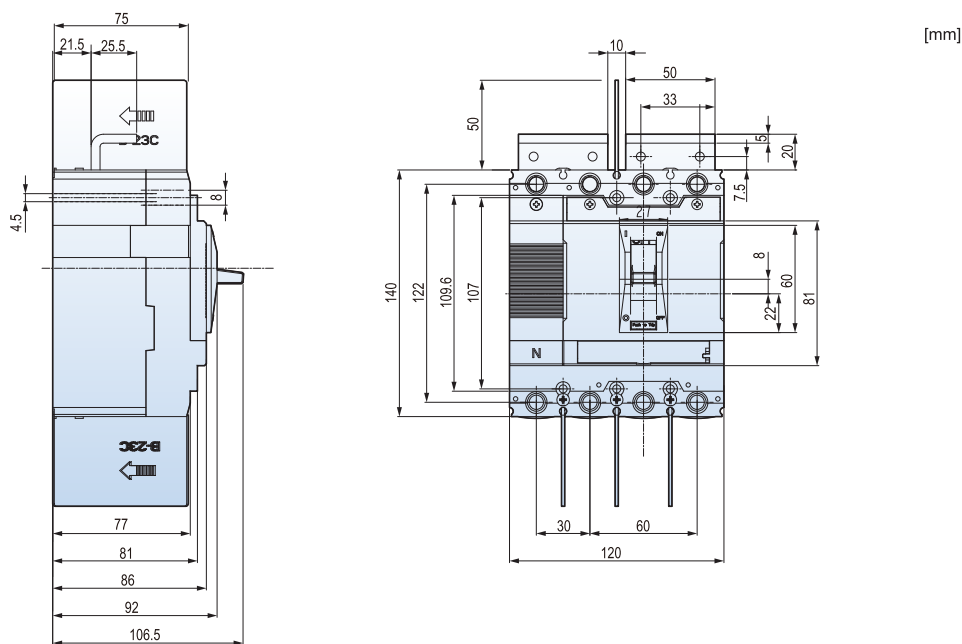

TS250

Dimension of MCCB with short BUSBAR

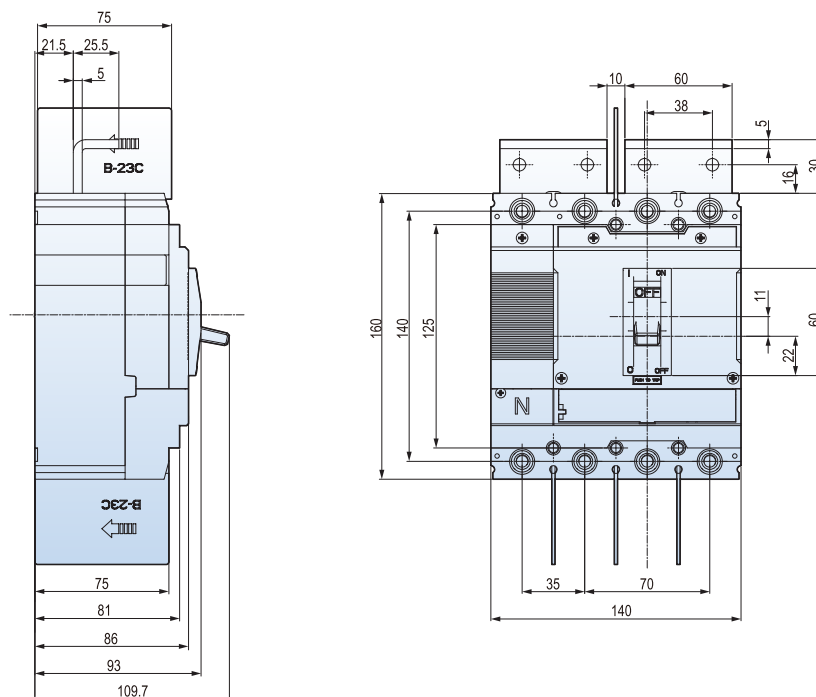



Overall dimensions (DC 1000V PV MCCB)

TS630

Dimension of MCCB with short BUSBAR

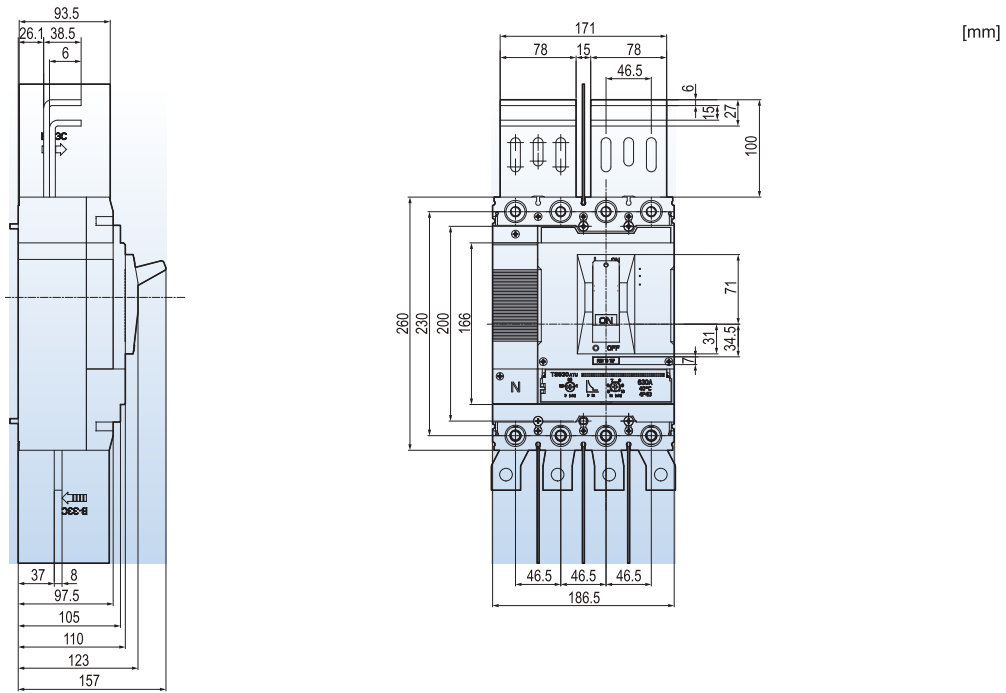

TS800

Dimension of MCCB with short BUSBAR

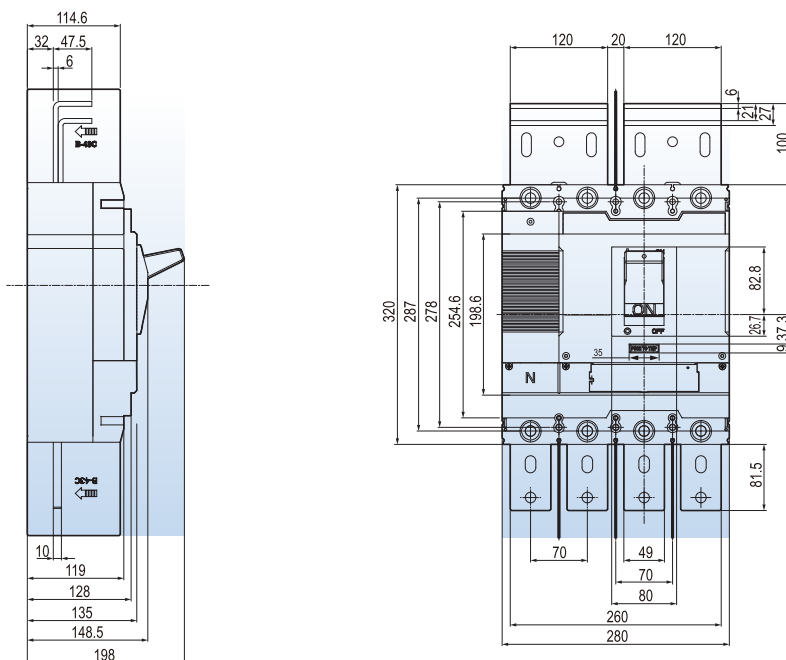

Overall dimensions (DC 1000V PV MCCB)

TD160

Short BUSBAR dimension

TD160 3t Short Busbar

[mm]

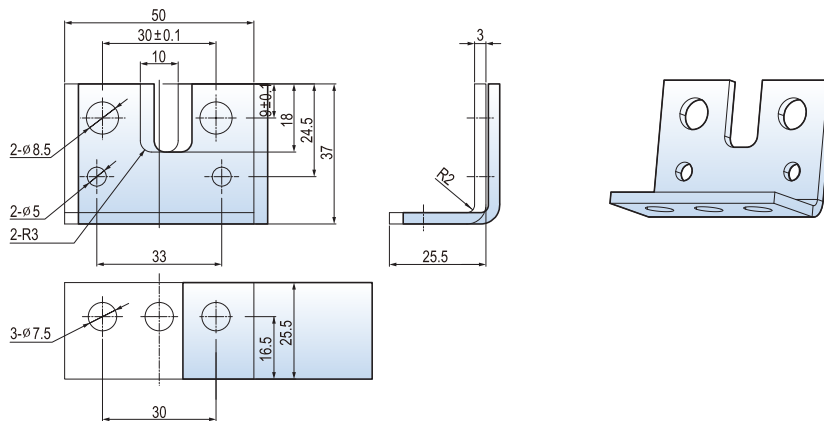

TD160 4t Short Busbar

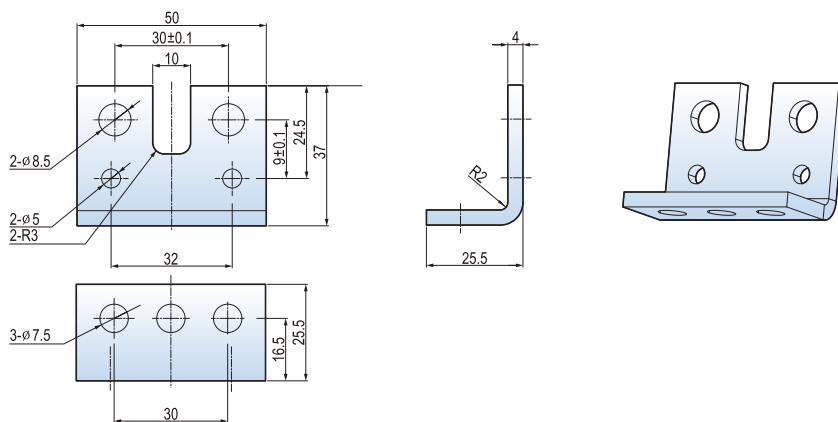

TD160 5t Short Busbar

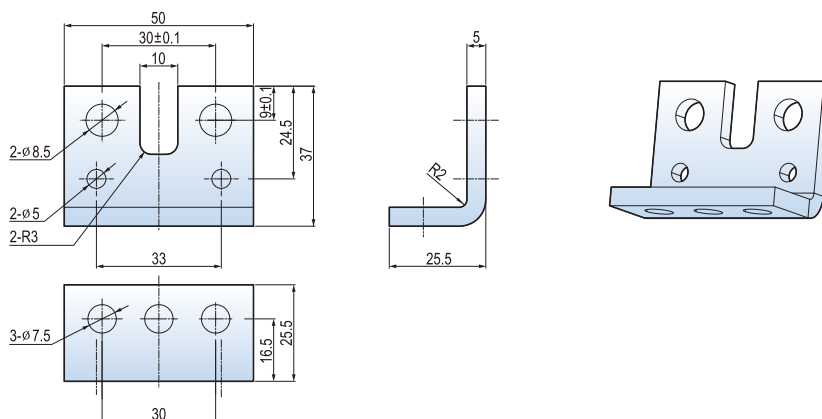

Overall dimensions (DC 1000V PV MCCB)

TS250

Short BUSBAR dimension

TS250 4t Short Busbar

[mm]

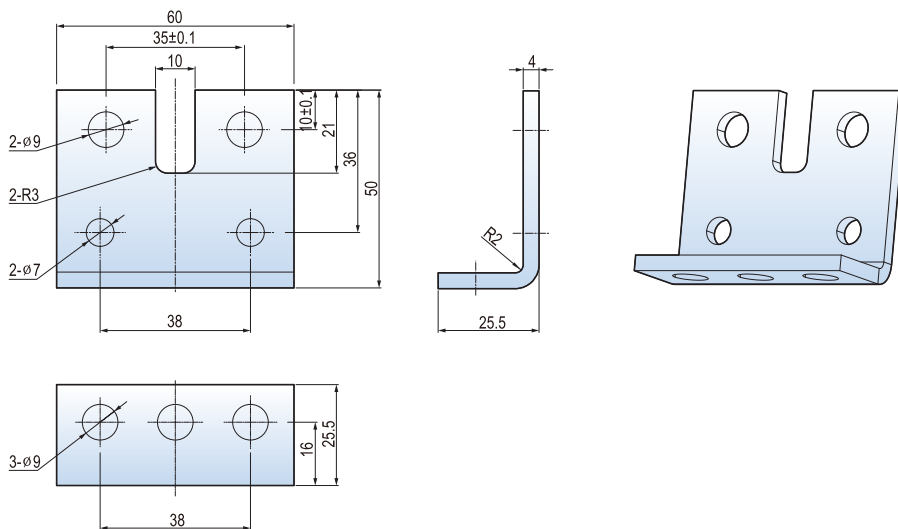

TD250 5t Short Busbar

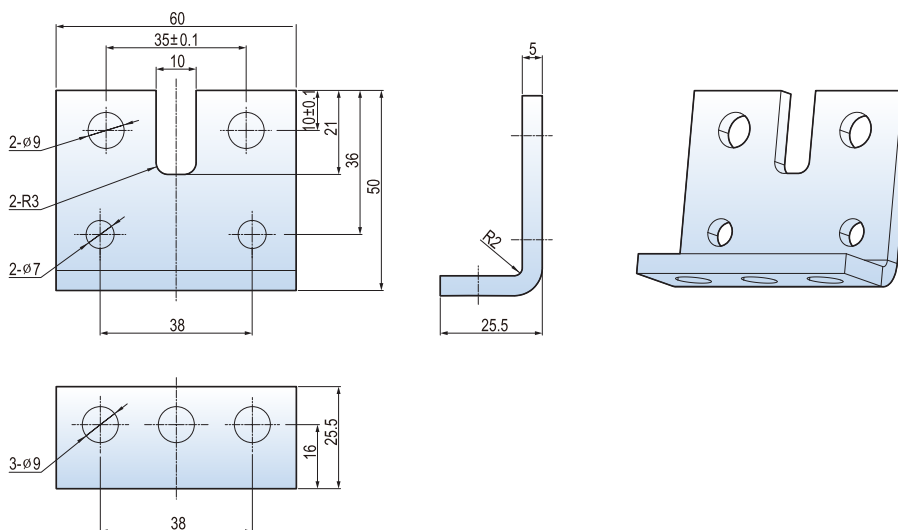

Overall dimensions (DC 1000V PV MCCB)

TS630

Short BUSBAR dimension

TS630 Lower Short Busbar

[mm]

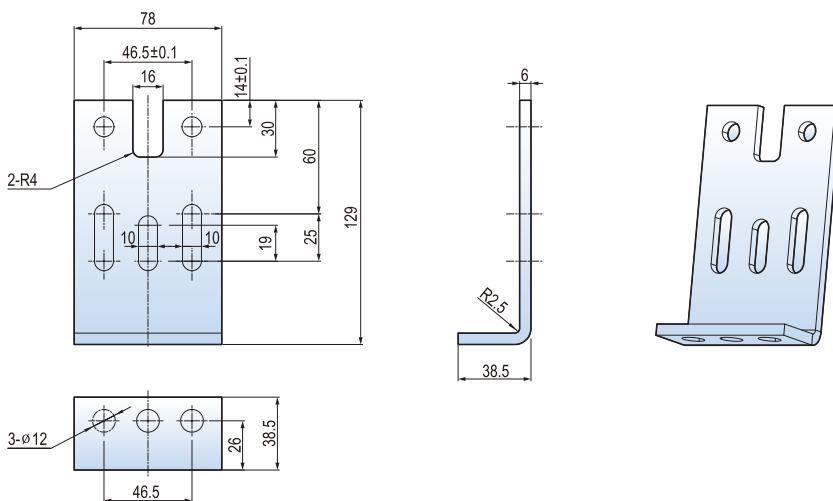

TS630 Upper Short Busbar

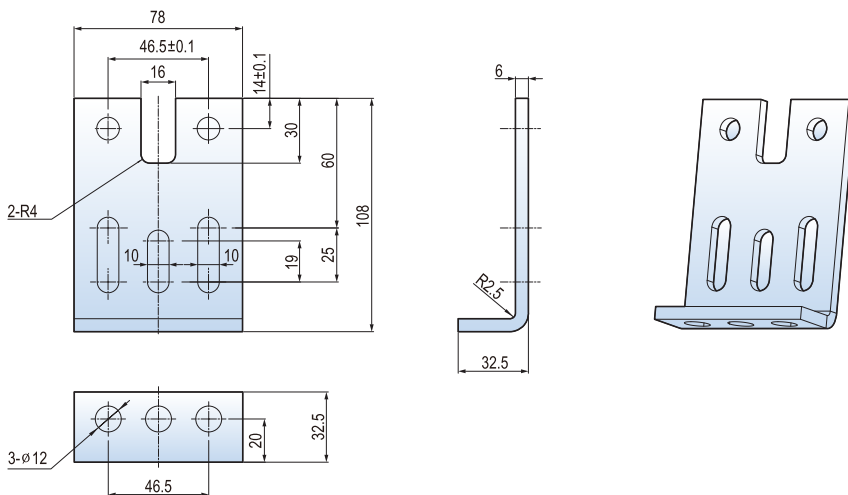



Overall dimensions (DC 1000V PV MCCB)

TS800

Short BUSBAR dimension

TS800 Lower Short Busbar

[mm]

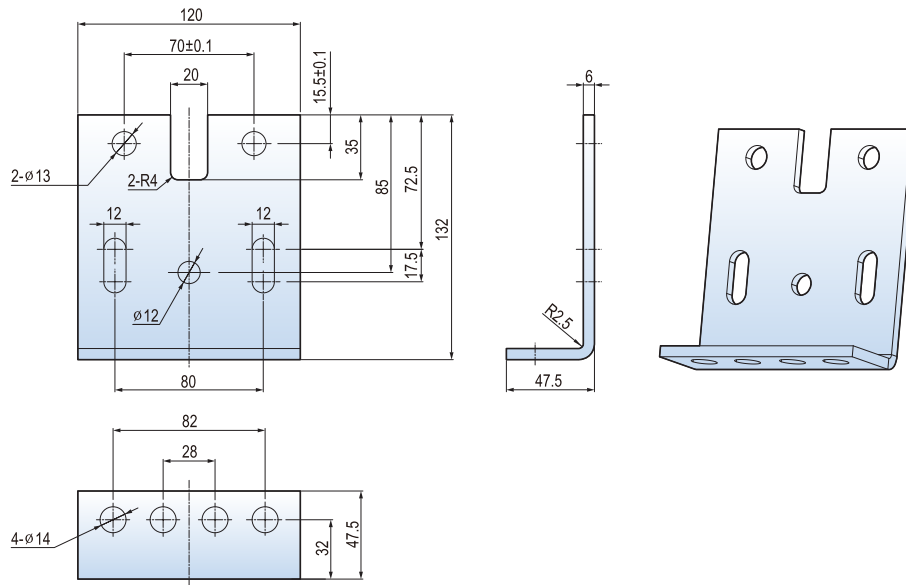

TS800 Upper Short Busbar

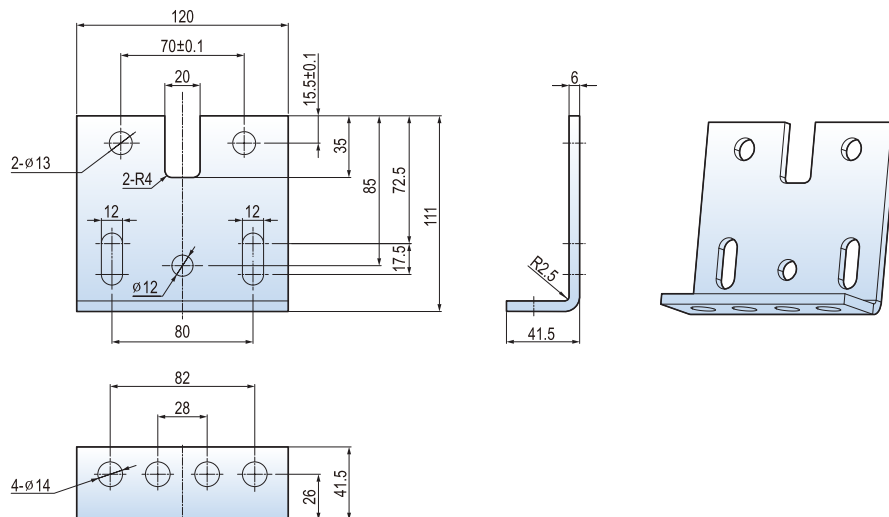



Technical information

Application Using circuit-breakers in DC networks

Susol circuit-breakers for protection of power distribution with thermal overload and magnetic short-circuit trip units are suitable for usage in DC networks.
 The circuit-breakers with electronic overcurrent releases are not suitable for DC networks.

Circuit-breaker selection criteria

The followings are the most important criteria for selection of suitable circuit breaker for DC networks.

- The rated current determines the rating and size of the circuit-breaker (Equipment)
- The rated voltage determines the number of poles in series necessary for breaking
- The maximum short-circuit current at the connection point determines the breaking capacity

Setting range of the trip values

- Thermal overload protection: Same setpoints as in 50/60Hz circuits
- Instantaneous short-circuit protection: The response threshold increases by maximum 40%.

The following wiring diagrams are recommended since the current must flow through all current paths in order to conform to the thermal tripping characteristic curve.

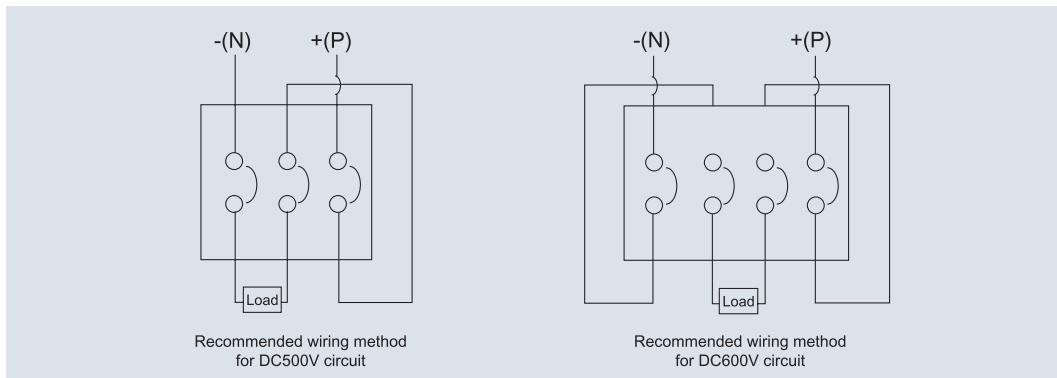

	Model	Trip unit	Applicable to DC circuits	Breaking capacity (kA)
Thermal magnetic	TD100N, TD160N	FTU FMU ATU	○	42
	TS100N, TS160N, TS250N		○	50
	TS400N, TS630N			
	TS800N		○	65
	TD100H, TD160H			
	TS100H, TS160H, TS250H			
	TS400H, TS630H		○	85
TS800H	○	100		
TD100L, TD160L				
TS100L, TS160L, TS250L				
TS400L, TS630L				
TS800L				
Electronic	TS250, TS630, TS800	ETS, ETM	Impossible to use to DC circuits	



TEL : 886-2-8991-2796
FAX : 886-2-8991-9298
service@jdauspice.com
www.jdauspice.com